

Civil Action No. 14-cv-317 (EGS)

EXHIBIT 1

Declaration of Katherine L. Myrick (Sept. 29, 2014)

**UNITED STATES DISTRICT COURT
FOR THE DISTRICT OF COLUMBIA**

ELECTRONIC PRIVACY INFORMATION)
CENTER,)

Plaintiff)

v.)

Civil Action No. 14-cv-317 (EGS)

DRUG ENFORCEMENT ADMINISTRATION,)

Defendant)

DECLARATION OF KATHERINE L. MYRICK

I, Katherine L. Myrick, pursuant to the provisions of 28 U.S.C. §1746, declare as follows:

1. I am currently assigned as the Chief of the Freedom of Information/Privacy Act Unit (the “FOIA Unit”) of the United States Department of Justice (“DOJ”), Drug Enforcement Administration (“DEA”), located at DEA’s Headquarters in Arlington, Virginia. I have served in this capacity since 1998 and oversee the processing of requests to DEA under the Freedom of Information Act (“FOIA”), 5 U.S.C. § 552, and the Privacy Act of 1974, 5 U.S.C. § 552a. My FOIA/Privacy Act experience at DEA dates back to 1983. The FOIA Unit is the central DEA office responsible for responding to requests for DEA information under the FOIA and Privacy Act and searching for, processing, and releasing DEA information in response to such requests.
2. Due to my experience in responding to requests for DEA’s records since 1983, and the nature of my official duties, I am familiar with the policies and practices of DEA and the DOJ related to searching for, processing, and releasing DEA information responsive to FOIA and

Privacy Act requests. I am familiar with the request of Plaintiff Electronic Privacy Information Center (“EPIC”) to DEA that is the basis of this action.

3. DEA submits this Declaration to provide information about DEA’s search for records and information responsive to EPIC’s request and to explain the justifications for DEA’s withholding of records and information pursuant to FOIA exemptions (b)(5), (b)(6), (b)(7)(C), (b)(7)(D), (b)(7)(E), and (b)(7)(F).

4. The statements I make in this Declaration are made on the basis of my review and analysis of the file in this case, my own personal knowledge, and/or information acquired by me through the performance of my official duties.

DEA’s LAW ENFORCEMENT MISSION

5. DEA’s mission includes enforcing the controlled substances laws and regulations of the United States. DEA’s investigative jurisdiction derives from the Controlled Substances Act, 21 U.S.C. § 801, *et seq.* (hereinafter, “the CSA” or “the Act”). The CSA authorizes DEA to enforce the Act through the investigation of trafficking in controlled substances and the violators who operate at interstate and international levels. This mission involves conducting criminal investigations to assist prosecutions of organizations and principal members of organizations involved in the growing, manufacture, or distribution of controlled substances appearing in or destined for illicit traffic in the United States.

EPIC’S FOIA REQUEST

6. Set forth below are a chronology and description of the pertinent correspondence concerning the Freedom of Information Act request received from the Electronic Privacy

Information Center (no. 14-00009-F). Copies of the relevant correspondence are attached hereto as Exhibits A – E.

7. By letter dated September 25, 2013, EPIC sought copies of four categories of documents relating to the Hemisphere Program. *See* September 25, 2013, letter from EPIC, attached hereto as Exhibit A.

8. DEA acknowledged receipt of EPIC’s letter by letter dated October 24, 2013, and advised EPIC that its request had been assigned case number 14-00009-F. *See* Letter from the DEA to EPIC, dated October 24, 2013, attached hereto as Exhibit B.

9. By letter dated November 13, 2013, the DEA informed EPIC that the request contained in its September 25, 2013, letter did not meet the requirements of the FOIA because it did not reasonably describe the requested records and did not comply with applicable Department of Justice regulations. The letter invited EPIC to reformulate its request by specifying the DEA records systems and offices to be searched. The letter informed EPIC that if DEA did not receive a reformulated request within 30 days, DEA would assume that EPIC did not wish to pursue its request and would administratively close the request. *See* Letter from DEA to EPIC, dated November 13, 2013, attached hereto as Exhibit C.

10. By letter dated November 15, 2013, EPIC submitted a revised request seeking the following categories of documents “from DEA Headquarters and DEA division offices in Atlanta, Houston, Los Angeles, and Washington, D.C.”:

1) All Hemisphere training modules, request forms, and similar final guidance documents that are used in the day-to-day operation of the program.

2) Any analyses, memos, opinions, or other communications that discuss the legal basis of the program.

3) Any analyses, memos, opinions or other communications that discuss the privacy impact of the program.

4) Any presentations, analyses, memos, opinions or other communications for Congress that cover Hemisphere's operations.

See Letter from EPIC to DEA, dated November 15, 2013, attached hereto as

Exhibit D.

11. By letter dated July 21, 2014, DEA advised EPIC of its determination in response to EPIC's FOIA request. DEA's response letter referenced the enclosure of 319 pages of responsive records subject to FOIA. Of these 319 pages, 39 pages were released in full, 176 pages were released in part and withheld in part, and 104 pages were withheld in full. *See* Letter from DEA to EPIC, dated July 21, 2014, attached hereto as Exhibit E. In addition, I have been informed that on July 23, 2014, DEA's counsel in this action sent an electronic copy of the July 21, 2014, response, including the responsive records, to EPIC's counsel by electronic mail.

12. The response package mailed July 21, 2014, was subsequently returned to DEA with the endorsement "Not Deliverable as Addressed—Unable to Forward." DEA confirmed that the name and delivery address on the July 21, 2014, package exactly matched the information provided in the September 25, 2013, and November 15, 2013, correspondence from EPIC. I have been informed that DEA's counsel in this action informed EPIC's counsel that the package had been returned and asked if EPIC wished DEA to make a second delivery attempt. I understand that DEA's counsel did not receive a response to this inquiry.

13. By letter dated July 25, 2014, DEA provided EPIC corrected copies of four pages of the July 21, 2014, release. The corrected pages contained corrected markings but did not change the material withheld or released on the four pages.

14. After the July 21, 2014, release, DEA learned that its search efforts had unintentionally excluded a search avenue DEA had intended to pursue. Pursuing that avenue located 4 pages of responsive documents subject to FOIA that had not previously been located. DEA processed these documents and released them today, September 29, 2014.

**DEA'S SEARCHES FOR RECORDS AND INFORMATION
RESPONSIVE TO EPIC'S FOIA REQUEST**

15. In response to EPIC's FOIA request, the FOIA Unit developed a multi-layer search strategy to uncover all responsive records and information.

16. EPIC's November 15, 2013, FOIA request sought records from "DEA Headquarters and DEA division offices in Atlanta, Houston, Los Angeles, and Washington, D.C." The FOIA Unit identified six offices at DEA Headquarters likely to have responsive records and tasked each of them with searching for responsive records: The DEA Operations Division, Intelligence Division, and Office of Training were included in the search given that the request sought "training modules, request forms, and similar final guidance documents that are used in the day-to-day operation of the program." The Office of Chief Counsel was included in the search given that EPIC's request sought "analyses, memos, opinions, or other communications that discuss the legal basis of the program." The Office of Information Systems was included in the search given that EPIC's request sought "analyses, memos, opinions or other communications that discuss the privacy impact of the program." The Office of Congressional and Public Affairs was included in the search given that EPIC's request sought "[a]ny presentations, analyses, memos, opinions or other communications for Congress." The FOIA Unit additionally tasked the four division offices

named in the request (Atlanta, Houston, Los Angeles, and Washington, D.C.) with searching for responsive records.

17. The Intelligence Division is the Headquarters office within DEA that, in coordination with other Federal, state, local, and foreign law enforcement organizations, is responsible for the collection, analysis, and dissemination of drug-related intelligence. Among other things, the DEA Intelligence Division helps initiate new investigations of major drug organizations, strengthens on-going investigations and subsequent prosecutions, and develops information that leads to seizures and arrests. The Intelligence Division staff most likely to know the location of any responsive records and information determined that any responsive records would have been received by email and would most likely be held in electronic form in the staff's email or network drives. The staff searched these locations using the keyword "Hemisphere" and sent all responsive records and information to the FOIA Unit.

18. The Headquarters component of DEA's Operations Division is responsible for providing strategic enforcement and administrative support to DEA's domestic field divisions and international country offices. That support consists of program administration; staffing; funding; coordination of joint investigations, enforcement initiatives and cases; and "right-sizing" of the entire Operations Division. The Hemisphere program is not a DEA program and is not used by the Operations Division at its Headquarters offices. The only office within the Operations Division that might have had responsive records was the Special Operations Division, which is the only Headquarters component of the Operations Division that conducts actual investigations. SOD leadership personnel who were most likely to know the location of responsive records and confirmed that SOD has no involvement with the Hemisphere program and did not have any responsive records.

19. The Office of Training is the office within DEA responsible for developing, delivering, and advocating law enforcement training to DEA personnel and appropriate Federal, state, local, and foreign law enforcement counterparts. The goals of this training are to improve individual and organizational performance and assist students in achieving the mission and goals of the law enforcement entities that employ them. The Office of Training staff most likely to know the location of responsive records and information searched all locations where responsive records would likely be held: it searched the office's network drive using the keyword "Hemisphere" and also conducted a manual search of current and retired paper-based lesson plans and an electronic search of retired lesson plans. These searches yielded no responsive records.

20. The Office of Chief Counsel is the office within DEA responsible for, among other things, providing legal services and guidance to all components of DEA in matters that arise in the conduct of DEA's mission to enforce the controlled substances laws and regulations of the United States. The Office of Chief Counsel analyzes the legal implications involved in policy decisions, advises and trains DEA personnel worldwide on criminal, civil, and regulatory legal issues, and represents DEA in civil and administrative litigation. The Office of Chief Counsel staff most likely to know the location of responsive records was an attorney who had worked on Hemisphere-related issues. That attorney determined that any responsive documents would most likely be held in electronic form in her email or personal storage drive. The attorney searched these locations for any responsive documents using a keyword search for the term "Hemisphere" and visually searching both locations. The attorney sent responsive materials she located to the FOIA Unit.

21. The Office of Information Systems is the office within DEA responsible for, among other things, DEA's information technology ("IT") equipment and software compliance with privacy

requirements. The staff most likely to know the location of responsive records and information searched for any files that included the term “Hemisphere” in the office’s privacy documentation file (which includes both paper and electronic files), the DEA IT system and application inventory, as well as a privacy electronic repository. These searches yielded no responsive record or information.

22. The Office of Congressional and Public Affairs is the Office within DEA responsible for, among other things, bringing awareness of United States’ controlled substances laws and regulations and their consequences to Congress and the media. Based on work recently done for purposes of responding to a congressional inquiry, staff within that office who was most likely to know the location of any responsive records knew that the Congressional and Public Affairs Office had no records or information responsive to EPIC’s request.

23. The DEA staff in the Atlanta division most likely to know the location of any responsive records and information determined that any responsive records would have been received by email and would most likely be held in electronic form in the staff’s email or personal network drives. The staff searched those locations using the search term “Hemisphere” and sent all responsive records and information to the FOIA Unit.

24. A supervisor in the Houston division who had the greatest knowledge about Hemisphere among the Division’s personnel and was in the best position to conduct a search gathered and sent to the FOIA unit all responsive records and information that he located within the Division.

25. The DEA staff in the Los Angeles division most likely to know the location of any responsive records and information determined that any responsive records would most likely be held in electronic form in the staff’s email or storage drives. The staff searched those locations

using the search term “Hemisphere” and sent all responsive records and information to the FOIA Unit.

26. The DEA staff in the Washington, D.C. division most likely to know the location of any responsive records and information determined that any responsive records would most likely be held in electronic form in the staff’s email or storage drives. The staff searched those locations using the search term “Hemisphere” and sent all responsive records and information to the FOIA Unit.

27. Using the search term “Hemisphere,” the FOIA Unit also searched the Narcotics and Dangerous Drugs Information System (NADDIS) for records responsive to EPIC’s request. NADDIS is the index to and the practical means by which DEA retrieves investigative reports and information from the Investigative Reporting and Filing System, the DEA’s investigative and intelligence Privacy Act system of records. This search yielded no responsive records.

CONSULTATIONS WITH AND REFERRALS TO OTHER AGENCIES

28. Within the records and information gathered pursuant to, and determined to be responsive to, EPIC’s request were records and information appearing to originate with other Federal offices. In accordance with 28 C.F.R. § 16.4, DEA consulted with those offices about whether these records and information are exempt from disclosure and, if so, whether they should be disclosed as a matter of administrative discretion. DEA processed these records and information, taking into account the input provided during the consultation process.

MATERIAL WITHHELD FROM DISCLOSURE IN RESPONSE TO EPIC'S REQUEST

29. The DEA applied Exemptions 5, 6, 7(C), 7(D), 7(E), and 7(F), 5 U.S.C. § 552(b)(5), (6), (7)(C)–(F), to withhold records and information responsive to EPIC's request.

30. On release page 318, the DEA also redacted a document that was not itself responsive to EPIC's request but contained a copy of an email message that was responsive to EPIC's request.

31. This declaration explains DEA's reasons for invoking particular exemptions and correlates them with the particular parts of the withheld material to which they apply. For each exemption asserted, this declaration divides the withheld portions of the documents into numbered categories. For each category, the declaration describes the material included in the category, explains how the exemption applies to the category, and lists release pages that contain material in that category. Exhibit F to this declaration contains copies of the pages released to the plaintiff that have been marked with the category numbers used in the declaration. The markings indicate what material on each page was placed into each category. In a number of instances, the same material is marked as belonging to more than one category because the material falls into more than one category, either because there is some overlap between the categories or because there is more than one justification for withholding the material.

Exemption (b)(5)

32. FOIA Exemption 5, 5 U.S.C. § 552(b)(5), authorizes withholding of "inter-agency or intra-agency memorandums or letters which would not be available by law to a party other than

an agency in litigation with the agency.” The exemption authorizes withholding of documents that are ordinarily privileged in civil discovery.

33. DEA withheld two documents based on Exemption 5. Both of the documents withheld based on Exemption 5 were created within the Department of Justice for internal Federal government use and therefore qualify as “inter-agency or intra-agency memorandums or letters.” The documents withheld would be protected in civil discovery based on the attorney-client privilege, the attorney work-product doctrine, and the deliberative process privilege.

34. DEA applied FOIA Exemption 5 to the following documents:

a. A draft memorandum prepared by an attorney in the DEA Office of Chief Counsel analyzing legal issues regarding the procedures used to obtain information through Hemisphere, intended to assist senior DEA management, and containing comments added by the same attorney regarding the same topics (category 5-1, release pages 157–68). This draft memorandum is covered by the attorney-client privilege because it contains a draft of confidential legal advice to the DEA and does not itself establish a final policy. This draft memorandum is covered by the attorney work-product doctrine because it was prepared by a DEA attorney in anticipation of litigation relating to the use of Hemisphere in law enforcement. The draft memorandum is covered by the deliberative process privilege because it was intended to facilitate or assist development of the agency’s final position on policies and procedures regarding use of Hemisphere and does not itself establish a final policy.

b. An email message from a Deputy Assistant Attorney General at DOJ to other Federal government employees containing a preliminary assessment of three issues relating to features of the Hemisphere program (category 5-2, release pages 318–19). The message is covered by the attorney-client privilege because it delivers confidential legal advice (albeit

preliminary advice) regarding these three issues and does not itself establish a final policy. The message is covered by the attorney work-product doctrine because it was prepared by a DOJ attorney in anticipation of litigation relating to the use of Hemisphere in law enforcement. The message is covered by the deliberative process privilege because it was intended to facilitate or assist development of the agency's final position on these aspects of the use of Hemisphere and does not itself establish a final policy.

Exemption (b)(6)

35. FOIA Exemption 6, 5 U.S.C. § 552(b)(6), authorizes withholding of "personnel and medical files and similar files the disclosure of which would constitute a clearly unwarranted invasion of personal privacy." Determining whether Exemption 6 is applicable entails balancing the individual's right of privacy against the public interest in shedding light on an agency's performance of its statutory duties or otherwise informing the public about government action.

36. DEA applied FOIA Exemption 6 to the following categories of information:

a. Names, telephone numbers, and email addresses of individual core mission law enforcement, law enforcement support, and individual personnel involved in the operation of Hemisphere (category 6-1, release pages 14, 16, 19, 22-24, 26, 33-34, 41, 43, 80, 83, 88, 155, 159, 165, 191-93, 232, 285, 304, 316, 287). This category is coextensive with categories 7C-1, 7E-8, and 7F-1 below. Releasing these individuals' names or contact information could expose them to threats or harassment. Releasing this information would not serve any public interest. Thus, releasing the information would constitute a clearly unwarranted invasion of personal privacy.

b. Names and photographs of crime victims, crime suspects, and the relative of a suspect contained in Hemisphere “success stories” containing accounts of law enforcement investigations in which Hemisphere was used (category 6-2, release pages 86, 88–90). This category is coextensive with category 7C-2. Releasing these individuals’ names in connection with law enforcement investigations would be stigmatizing. Although the release of these individuals’ names could shed light on how Hemisphere is used by law enforcement, any benefit of releasing their names would be outweighed by the harm to these individuals’ privacy interests or their survivors’ privacy interests. Thus, releasing the information would constitute a clearly unwarranted invasion of personal privacy.

Exemption (b)(7) Threshold Requirement

37. To justify withholding of material under any of the exemptions established under subsection (b)(7) of the FOIA, an agency must show that the record or information was compiled for law enforcement purposes. As stated in paragraph 5, *supra*, the DEA’s investigative jurisdiction derives from the CSA. The CSA authorizes the DEA to enforce the Act through the investigation of trafficking in controlled substances and the violators who operate at interstate and international levels. All of the documents responsive to EPIC’s request were compiled for law enforcement purposes. DEA compiled these records and information to support core mission DEA law enforcement officers and employees in the course of their official duties enforcing the CSA.

Exemption (b)(7)(C)

38. FOIA Exemption 7(C), 5 U.S.C. § 552(b)(7)(C), authorizes withholding of records or information compiled for law enforcement purposes to the extent that such records or information “could reasonably be expected to constitute an unwarranted invasion of personal privacy.” Determining whether Exemption 7(C) is applicable entails balancing the individual’s right of privacy against the public interest in shedding light on an agency’s performance of its statutory duties or otherwise informing the public about government action.

39. DEA applied FOIA Exemption 7(C) to the following categories of information:

a. Names, telephone numbers, and email addresses of individual core mission law enforcement, law enforcement support, and individual personnel involved in the operation of Hemisphere (category 7C-1, release pages 14, 16, 19, 22–24, 26, 33–34, 41, 43, 80, 83, 88, 155, 159, 165, 191–93, 232, 285, 304, 316, 287). This category is coextensive with categories 6-1, 7E-8, and 7F-1. Releasing these individuals’ names or contact information could expose them to threats or harassment. Releasing this information would not serve any public interest. Thus, releasing the information could reasonably be expected to constitute an unwarranted invasion of personal privacy.

b. Names and photographs of crime victims, crime suspects, and the relative of a suspect contained in Hemisphere “success stories” containing accounts of law enforcement investigations in which Hemisphere was used (category 7C-2, release pages 86, 88–90). This category is coextensive with category 6-2. Releasing these individuals’ names in connection with law enforcement investigations would be stigmatizing. Although the release of these individuals’ names could shed light on how Hemisphere is used by law enforcement, any benefit

of releasing their names would be outweighed by the harm to these individuals' privacy interests or their survivors' privacy interests.

Exemption (b)(7)(D)

40. FOIA Exemption 7(D), 5 U.S.C. § 552(b)(7)(D), authorizes withholding of records or information compiled for law enforcement purposes to the extent that such records or information "could reasonably be expected to disclose the identity of a confidential source, including a State, local, or foreign agency or authority or any private institution which furnished information on a confidential basis."

41. DEA applied FOIA Exemption 7(D) to one category of information: Information naming or otherwise identifying private-sector companies that are instrumental in the operation of Hemisphere (category 7D-1, release pages 7, 16, 17, 19, 22–26, 37, 43, 80, 116–17, 151, 155, 189–94, 196–98, 235, 287, 289). This category is coextensive with category 7E-6 below. These companies have a role in the operation of Hemisphere that entails providing information to the Government. According to DEA personnel who are familiar with Hemisphere, the companies provide information to law enforcement with the express expectation that both the source and the information will be afforded confidentiality and under circumstances where confidentiality can be inferred because providing the information can lead to retaliation against the companies.

Exemption (b)(7)(E)

42. FOIA Exemption 7(E), 5 U.S.C. § 552(b)(7)(E), authorizes withholding of records or information compiled for law enforcement purposes to the extent that such records or

information “would disclose techniques and procedures for law enforcement investigations or prosecutions, or would disclose guidelines for law enforcement investigations or prosecutions if such disclosure could reasonably be expected to risk circumvention of the law.”

43. All of the information that DEA withheld based on Exemption 7(E) consists of records that would disclose techniques and procedures or guidelines for law enforcement, specifically, Hemisphere and the use of Hemisphere in law enforcement investigations. Although the Department of Justice has publicly acknowledged the existence of Hemisphere and disclosed some information about the program, all of the information withheld by DEA based on FOIA Exemption 7(E) is more specific information that has not been disclosed by the Department of Justice and is not widely known to the public.

44. In evaluating the potential impact of disclosing information, DEA relied upon the experience and expertise of DEA personnel who are familiar with the use of Hemisphere in law enforcement and are familiar with the tactics and capabilities of the criminals who and criminal organizations that are the targets of DEA’s law enforcement efforts.

45. The information withheld under Exemption 7(E) falls into several categories:

a. Telephone and fax numbers and email addresses associated with the Hemisphere program (category 7E-1, release pages 1, 14, 34, 95, 98, 100–03, 121, 123, 125, 127, 129, 131, 133, 135, 137, 139, 141, 143, 145, 149, 153, 158, 160–63, 169, 171, 173, 176, 214–18, 222, 287, 317, 320, 322). This contact information could be used by criminals to disrupt law enforcement operations or obtain unauthorized access to information about such operations.

b. Parts of a form used to make Hemisphere requests; sample text for completing request forms, associated subpoenas, and other documents used in connection with Hemisphere requests; and other details of internal procedures and guidelines for making Hemisphere requests

or otherwise using Hemisphere (category 7E-2, release pages 1, 4, 9, 16–20, 22–26, 28–30, 92–93, 98–99, 104–06, 108–09, 111–13, 115–21, 123, 125, 127, 129, 131, 133, 135, 137, 139, 141, 143, 145, 147–49, 151–53, 155–63, 165–69, 171, 173, 176–78, 180, 183, 185–98, 200–13, 219, 222–23, 228, 256, 287, 318, 320, 322). Knowledge about what information is needed (or not needed) to make a Hemisphere request, and what particular procedures are used to make Hemisphere requests, would help criminals understand when and how law enforcement authorities are able to use Hemisphere against them and thereby help criminals tailor or adapt their activities to evade apprehension. Similarly, knowledge of internal guidelines and restrictions for the use of Hemisphere would help criminals tailor or adapt their activities to evade apprehension.

c. Technical details about how Hemisphere works and details about the specific capabilities and limitations of Hemisphere (category 7E-3, release pages 4, 8–11, 29–34, 38, 40, 43, 47, 51–53, 55, 58, 61–65, 67–68, 78–83, 86–88, 90, 93–94, 99, 104–08, 112–13, 118, 147–48, 156–68, 178–82, 185, 188, 200, 209, 212–13, 219, 224–28, 233, 235, 237, 239, 244–45, 253, 255–57, 259–67, 270–73, 279–83, 285, 287, 289, 291, 294–97, 309, 311–16, 318–19). Knowing what can and cannot be done with Hemisphere and precisely how it works could help criminals tailor or adapt their activities to evade apprehension.

d. Details regarding how Hemisphere requests are routed and processed and how resources are organized and deployed, including the specific terminology used to refer to certain Hemisphere resources and personnel (category 7E-4, release pages 4–6, 8–10, 13, 92–93, 95, 105–06, 119, 157–59, 176, 180, 184, 200, 222–23, 283–84, 287). Information about the resources allocated to Hemisphere and the manner in which those resources are organized and deployed would help criminals tailor or adapt their activities to evade apprehension.

e. Information naming or otherwise directly identifying specific law enforcement agencies, other than DEA, that have access to Hemisphere (category 7E-5, release pages 6, 9, 19, 23–26, 86, 88, 90, 105, 111–12, 161, 184, 189, 191–94, 217–20). Because every law enforcement agency has its own individual focus and sphere of authority, knowing which particular law enforcement agencies have access to Hemisphere would help criminals tailor or adapt their activities to evade apprehension.

f. Information naming or otherwise identifying private-sector companies that are instrumental in the operation of Hemisphere (category 7E-6, release pages 7, 16, 17, 19, 22–26, 37, 43, 80, 116–17, 151, 155, 189–94, 196–98, 235, 287, 289). This category is coextensive with category 7D-1 above. As explained above, the material in this category either names or uniquely identifies private-sector companies that are instrumental in the operation of Hemisphere. Knowing the identities of such companies could help criminals tailor or adapt their activities to evade apprehension. It could also assist efforts to attack facilities involved in the Hemisphere program.

g. Details about how Hemisphere results and output are delivered to and presented to law enforcement, including sample results displays (category 7E-7, release pages 10, 33–34, 40–60, 62–83, 93, 106, 159, 161, 166, 168, 179, 181, 212, 222, 224, 228–29, 231–85, 287–309, 311–16). Knowledge of this information could help criminals tailor or adapt their activities to evade apprehension.

h. Names, telephone numbers, and email addresses of individual core mission law enforcement, law enforcement support, and individual personnel involved in the operation of Hemisphere (category 7E-8, release pages 14, 16, 19, 22–24, 26, 33–34, 41, 43, 80, 83, 88, 155, 159, 165, 191–93, 232, 285, 304, 316, 287). This category is coextensive with categories 6-1,

7C-1, and 7F-1. Criminals could use these individuals' names or contact information to make threats against these individuals. Criminals could also use the information to disrupt or gather information about law enforcement operations by impersonating these individuals or by contacting them or feigning familiarity with them.

i. Details regarding how Hemisphere requests are prioritized and the implications of that prioritization for the handling of requests (category 7E-9, release pages 28, 98–99, 109, 180, 209–11, 322). Information about how requests are prioritized would help criminals tailor or adapt their activities to avoid apprehension.

j. Hemisphere “success stories” containing accounts of law enforcement investigations in which Hemisphere was used, and explaining the precise role played by Hemisphere in each investigation (category 7E-10, release pages 86–90). Information about how Hemisphere contributed to the apprehension of a suspect in a particular case would help criminals tailor or adapt their activities to avoid apprehension.

k. Documents detailing the means through which Hemisphere secures the cooperation of entities instrumental to Hemisphere's operations, and references to those documents (category 7E-11, release pages 283, 286–87). Disclosure of the documents, any meaningful parts of the documents, or references to the documents would reveal this means of securing cooperation and could reasonably be expected to lead to disruption of the means of securing cooperation. Providing a more specific description of this potential risk would entail revealing the withheld information.

Exemption (b)(7)(F)

46. FOIA Exemption 7(F), 5 U.S.C. § 552(b)(7)(F), authorizes withholding of records or information compiled for law enforcement purposes to the extent that such records or information “could reasonably be expected to endanger the life or physical safety of any individual.”

47. The information withheld under Exemption 7(F) falls within a single category: Names, telephone numbers, and email addresses of individual core mission law enforcement, law enforcement support, and individual personnel involved in the operation of Hemisphere (category 7F-1, release pages 14, 16, 19, 22–24, 26, 33–34, 41, 43, 80, 83, 88, 155, 159, 165, 191–93, 232, 285, 304, 316, 287). This category is coextensive with categories 6, 7C-1, and 7E-8. Revealing these individuals’ names could make them targets of threats. Revealing their contact information could lead to discovery of their individual identities and thereby expose them to possible threats.

48. Segregability: All responsive records, 323, were examined to determine whether any reasonably segregable information could be released after applying exemptions to each record while considering the foreseeable harm that release would pose to interests protected by such exemptions. As a result, forty-one (41) pages were identified for release in full because it was determined that DEA will not apply any FOIA exemption to them. An additional 178 pages were released in part. Given the application of one or more Exemptions, 104 pages were withheld in full. After applying one or more exemption to each page, only blank pages, or pages with incomprehensible words and phrases, would remain. The release of that information would not contribute to the understanding of how the DEA or the United States conducts business either in general or specifically related to the matters requested by Plaintiff.

I declare under penalty of perjury that the foregoing is true and correct.

Executed on September 29, 2014.

A handwritten signature in cursive script that reads "Katherine L. Myrick". The signature is written in black ink and is positioned above the printed name.

Katherine L. Myrick

Chief,

Freedom of Information/Privacy Act Unit

Drug Enforcement Administration

Arlington, VA 22202

EXHIBIT A

SARF OCT 18 '13 PM 12:26

epic.org

September 25, 2013

VIA CERTIFIED MAIL

Katherine L. Myrick, Chief
Freedom of Information Operations Unit
Drug Enforcement Administration
8701 Morrissette Drive
Springfield, VA 22152

1718 Connecticut Ave NW
Suite 200
Washington DC 20009
USA
+1 202 483 1140 (tel)
+1 202 483 1248 (fax)
www.epic.org

Re: Freedom of Information Act Request

Dear Ms. Myrick,

This letter constitutes a request under the Freedom of Information Act ("FOIA"), 5 U.S.C. § 552, and is submitted on behalf of the Electronic Privacy Information Center ("EPIC") to the Drug Enforcement Agency ("DEA").

EPIC seeks records related to the Hemisphere Program, as detailed below.

Background

Earlier this month, the *New York Times* reported on a previously secret government program called "Hemisphere," which has been in operation since at least 2007.¹ Hemisphere allows law enforcement personnel in multiple agencies to access billions of phone records of AT&T customers, as well as any non-customers whose communication is routed through an AT&T switch.² The data is accessed primarily for counternarcotics investigations, but is also used for a variety of other law enforcement activities.³ The program is funded by the DEA and the White House's Office of National Drug Control Policy.⁴

Details of the Hemisphere program are set out in a PowerPoint training presentation.⁵ The PowerPoint explains that Hemisphere supplies "electronic call detail records (CDRs)" in response to both administrative and grand jury subpoenas.⁶ Every day, AT&T adds 4 billion new

¹ Scott Shane & Colin Moynihan, *Drug Agents Use Vast Phone Trove, Eclipsing N.S.A.'s*, *N.Y. Times*, Sept. 2, 2013, at A1, also available at http://www.nytimes.com/2013/09/02/us/drug-agents-use-vast-phone-trove-eclipsing-nsas.html?pagewanted=all&_r=0

² Evan Perez, *DEA Program Linked to Vast AT&T Database*, *CNN*, Sept. 2, 2013, <http://security.blogs.cnn.com/2013/09/02/dea-program-linked-to-vast-att-database-documents-show/>

³ Shane & Moynihan, *supra* note 1.

⁴ Mike Levine, *DEA Puts Phone Company Inside Government Offices*, *ABC News*, Sept. 1, 2013, <http://abcnews.go.com/blogs/headlines/2013/09/dea-program-puts-phone-company-inside-government-offices/>

⁵ Shane & Moynihan, *supra* note 1.

⁶ PowerPoint, *Los Angeles Hemisphere. High Intensity Drug Trafficking Area*, at 2, available at <http://s3.documentcloud.org/documents/782287/database.pdf>

records to the Hemisphere database.⁷ Hemisphere participants are supplied with training modules⁸ and fill out standardized subpoena request forms.⁹

A government subpoena to AT&T will retrieve CDRs on calls made as recently as one hour before the request was approved, and as far back as 1987.¹⁰ For the period and region covered by the PowerPoint, 96 percent of requests came from either the DEA or DHS.¹¹

Hemisphere is the largest telephone record collection program reported to date.¹² The program includes extensive location information.¹³ Hemisphere allows law enforcement to gather extensive electronic information from U.S. citizens while instructing program participants to "wall off" any reference to Hemisphere in any public document.¹⁴

While all records are stored by a private company,¹⁵ four of that company's employees are paid by the government.¹⁶ Additionally, the government uses an algorithm, untethered to judicial authority, to determine which phone records to subpoena,¹⁷ raising questions about how often records are retrieved for people not under investigation.¹⁸

Documents Requested

EPIC requests copies of the following agency records:

- 1) All Hemisphere training modules, request forms, and similar final guidance documents that are used in the day-to-day operation of the program.
- 2) Any analyses, memos, opinions, or other communications that discuss the legal basis of the program.
- 3) Any analyses, memos, opinions, or other communications that discuss the privacy impact of the program.
- 4) Any presentations, analyses, memos, opinions or other communications for Congress that cover Hemisphere's operations.

⁷ Perez, *supra* note 2.

⁸ *Id.* at 8.

⁹ *Id.* at 6.

¹⁰ *Id.* at 3.

¹¹ *Id.* at 16.

¹² Shane & Moynihan, *supra* note 1.

¹³ PowerPoint, *supra* note 6, at 3.

¹⁴ PowerPoint, *supra* note 6, at 12.

¹⁵ Gene Johnson & Eileen Sullivan, *Drug Agents Plumb Vast Database of Call Records*, Associated Press, Sept. 3, 2013.

<http://www.businessweek.com/ap/2013-09-02/drug-agents-plumb-vast-database-of-call-records>

¹⁶ Perez, *supra* note 2. An ACLU Spokesperson points out that "to the extent that this is a government program, it's subject to the Fourth Amendment."

¹⁷ *Id.*

¹⁸ Johnson & Sullivan, *supra* note 15.

Request for Expedited Processing

Expedited processing is justified because the request: 1) is made by an organization “primarily engaged in disseminating information”; and 2) covers information about which there is an “urgency to inform the public about an actual or alleged federal government activity.” 5 U.S.C. § 552(a)(6)(E)(v)(II); *Al-Fayed v. CIA*, 254 F.3d 306 (D.C. Cir. 2001).

EPIC is an organization “primarily engaged in disseminating information.” *American Civil Liberties Union v. Department of Justice*, 321 F. Supp. 2d 24, 29 n.5 (D.D. Cir. 2004).

There is an “urgency to inform the public” about Hemisphere, which is an “actual government activity.” News of the Hemisphere Program broke on the front page of the *New York Times* on September 2¹⁹ and it has also been covered by ABC News,²⁰ NBC News,²¹ Fox News,²² CNN,²³ the *Philadelphia Enquirer*,²⁴ and the Associated Press.²⁵ Internationally, both the *Guardian* of London²⁶ and the *Daily Mail*²⁷ featured stories on the program. Summarizing the view of civil libertarians quoted in these stories, the American Civil Liberties Union explains that “the NSA’s untethered snooping is eclipsed by [the Hemisphere Program]... “[A]s with so many of government surveillance programs, Hemisphere raises serious constitutional questions...”²⁸

The U.S. Congress is currently debating the scope of government surveillance. For example, since June 11, no fewer than fifteen bills that that would limit the scope of government

¹⁹ Shane & Moynihan, *supra* note 1. (“The scale and longevity of the data storage appears to be unmatched by other government programs, including the N.S.A.’s gathering of phone call logs under the Patriot Act ... Daniel C. Richman, a law professor at Columbia ... said the program at least touched on an unresolved Fourth Amendment question: whether mere government possession of huge amounts of private data, rather than its actual use, may trespass on the amendment’s requirement that searches be ‘reasonable.’ Even though the data resides with AT&T, the deep interest and involvement of the government in its storage may raise constitutional issues, he said.”).

²⁰ Levine, *supra* note 4. (“Asked whether AT&T customers should have more of an opportunity to respond to subpoenas for their information under Hemisphere, the official noted that AT&T can challenge a subpoena under Hemisphere, just as the company can with subpoenas outside Hemisphere. In those cases, the customer is not immediately aware of the subpoena to challenge it either.”).

²¹ Richard Esposito, *DEA phone call database bigger than NSA’s*, NBC News, Sept. 2, 2013, <http://investigations.nbcnews.com/news/2013/09/02/20293683-dea-phone-call-database-bigger-than-nsas?lite> (“The pool grows by billions of calls a day, includes information on the location of callers, and is larger than the controversial database maintained by the NSA...”).

²² *Drug agents reportedly have access to bigger phone database than NSA’s*, Fox News, <http://www.foxnews.com/politics/2013/09/02/drug-agents-reportedly-have-access-to-bigger-phone-database-than-nsa/>

²³ Perez, *supra* note 2. (“The documents surface amid controversy over government surveillance programs ... that collect phone, e-mail and other records in an effort to thwart terror attacks.”).

²⁴ *Inquirer Editorial: Data trolling violates rights*, Philadelphia Enquirer, Sept. 5, 2013, http://articles.philly.com/2013-09-05/news/41769068_1_phone-records-phone-call-drug-dealers (“The net [spy agencies] use to troll for information is too wide, and too likely to cause unwarranted violations of Americans’ right to privacy. Now comes news that it isn’t just the National Security Agency that, in its pursuit of terrorists possibly plotting mayhem, uses this scattershot approach to domestic targets.”).

²⁵ Johnson & Sullivan, *supra* note 15. (“The details of the Hemisphere Project come amid a national debate about the federal government’s access to phone records, particularly the bulk collection of phone records for national security purposes.”).

²⁶ James Ball, *US drug agency partners with AT&T for access to ‘vast database’ of call records*, The Guardian, Sept. 2, 2013, <http://www.theguardian.com/world/2013/sep/02/nsa-dea-at-t-call-records-access> (“Unlike the controversial call record accesses obtained by the NSA, the data is stored by AT&T, not the government, but officials can access individual’s phone records within an hour of an administrative subpoena.”).

²⁷ Michael Zennie, *REVEALED: Secret program gives federal agents nearly instant access to BILLIONS of AT&T phone records without a court order*, Daily Mail, Sept. 2, 2013, <http://www.dailymail.co.uk/news/article-2408681/REVEALED-Secret-program-gives-federal-agents-nearly-instant-access-BILLIONS-AT-amp-T-phone-records-court-order.html> (“The Times reports that in many cases, no court order or grand jury subpoena is needed to receive these records - meaning that checks and balances on the process are limited or even non-existent.”).

²⁸ Ezekiel Edwards, *Drug Agents Have an NSA-Style Spying Problem*, ACLU Blog of Rights, Sept. 4, 2013, <https://www.aclu.org/blog/criminal-law-reform-national-security/drug-agents-have-nsa-style-spying-problem>

surveillance have been introduced in the Congress.²⁹ Most recently, on September 20, House Select Committee on Intelligence senior member Rep. Adam Schiff introduced the “Ensuring Adversarial Process in the FISA Court Act.” The goal of the legislation according to Rep. Schiff is to protect “the Fourth Amendment and privacy concerns of ordinary Americans.”³⁰ Last month, two surveillance-inspired bills were introduced that focus on “constitutional and statutory requirements to safeguard individual rights to privacy and liberty.”³¹ Senator Tom Udall, explaining his decision to co-sponsor both bills, stated that “Americans deserve the assurance that their civil liberties are not being swept aside behind closed doors.”³²

Just last month, President Obama acknowledged the need for “clear safeguards to prevent abuse and protect the rights of the American people”³³ with regard to surveillance programs. The President announced specific steps that he was taking to “move the debate [on surveillance] forward.”³⁴ Specifically, he stated that he would: 1) work with Congress to reform the section of the Patriot Act that collects telephone records to add “additional safeguards against abuse”; 2) “direct[] the intelligence community to make public as much information about these programs as possible”; and 3) create “a high-level group of outside experts to review our entire intelligence and communications technologies.”³⁵ The group’s mandate is to “make sure that there absolutely is no abuse in terms of how these surveillance technologies are used.”³⁶ The President explained that the group will “provide an interim report in 60 days and a final report by the end of this year, so that we can move forward with a better understanding of how these programs impact our security, our privacy, and our foreign policy.”³⁷

In order to comment on the privacy and other issues raised by Hemisphere, which are of significant and immediate national concern, the public should have access to information about the scope of and legal authority for the program, as well as how call detail records are used, the adequacy of privacy safeguards, and other privacy implications.

Request for News Media Fee Status

EPIC is a representative of the news media. *EPIC v. Dep't of Defense*, 241 F.Supp. 2d 5 (D.D.C. 2003). Based on our status as a news media requester, we are entitled to receive the requested records with only duplication fees assessed.

²⁹ H.R. 2399, LIBERT-E Act; H.R. 2440, FISA Court in the Sunshine Act of 2013; H.R. 2475, Ending Secret Law Act; H.R. 2586, FISA Court Accountability Act; H.R. 2684, Telephone Surveillance Accountability Act of 2013; H.R. 2736, Government Surveillance Transparency Act of 2013; H.R. 2761, Presidential Appointment of FISA Court Judges Act; H.R. 2818, Surveillance State Repeal Act; H.R. 2849, Privacy Advocate General Act of 2013; Ensuring Adversarial Process in the FISA Court Act; S. 1130, Ending Secret Law Act; S. 1215, FISA Accountability and Privacy Protection Act of 2013; S. 1452, Surveillance Transparency Act of 2013; S. 1460, FISA Judge Selection Reform Act of 2013; S. 1467, FISA Court Reform Act of 2013.

³⁰ Press Release, Office of Rep. Adam Schiff, *Rep. Schiff Introduces Legislation to Reform FISA Court and Allow Independent, Public Interest Advocate* (Sept. 20, 2013) (available at <https://schiff.house.gov/press-releases/rep-schiff-introduces-legislation-to-reform-fisa-court-and-allow-independent-public-interest-advocate/>).

³¹ Press Release, Office of Sen. Richard Blumenthal, *Blumenthal Unveils Major Legislation to Reform FISA Courts* (Aug. 1, 2013) (available at <http://www.blumenthal.senate.gov/newsroom/press/release/blumenthal-unveils-major-legislation-to-reform-fisa-courts>).

³² *Id.*

³³ President Barack Obama, *Remarks by the President in a Press Conference* (Aug. 9, 2013) (available at <http://www.whitehouse.gov/the-press-office/2013/08/09/remarks-president-press-conference>).

³⁴ *Id.*

³⁵ *Id.*

³⁶ *Id.*

³⁷ *Id.*

Further, because disclosure of this information will “contribute significantly to public understanding of the operations or activities of the government,” as described above, any duplication fees should be waived. 5 U.S.C. § 552(a)(4)(A)(iii).

Thank you for your consideration of our request. As provided in 6 C.F.R. § 5.5(d)(4), we will anticipate your determination on our request for expedited processing within 10 business days. For questions regarding this request, we can be contacted at 202-483-1140, x 120, or FOIA@epic.org.

Sincerely,

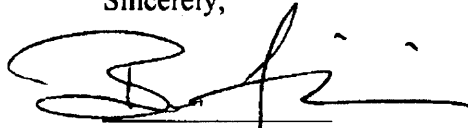
A handwritten signature in black ink, appearing to read 'Bruce Friedrich', written over a horizontal line.

Bruce Friedrich
EPIC Extern

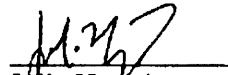
A handwritten signature in black ink, appearing to read 'Julia Horwitz', written over a horizontal line.

Julia Horwitz
EPIC Open Government Coordinator

EXHIBIT B



OCT 24 2013

Case Number: 14-00009-F

Subject: Information related to the Hemisphere Program

Bruce Friedrich
Electronic Privacy Information Center
1718 Connecticut Ave NW
Suite 200
Washington, DC 20009

Dear Mr. Friedrich:

This letter responds to your Freedom of Information/Privacy Act (FOI/PA) request dated September 25, 2013, received by the Drug Enforcement Administration (DEA), Freedom of Information/Privacy Act Unit (SARF), seeking access to DEA records. Your request has been opened and assigned the above case number. Please include this case number when corresponding with this office.

This letter confirms your obligation that by filing your request, you have agreed to pay all applicable fees charged under 28 C.F.R. § 16.111, up to \$25.00. No fees are due at this time.

In order to expedite all requests, your request will be handled in chronological order based on the date of this letter. If you have any questions regarding this letter, you may contact our Customer Service Hotline Representative on (202) 307-7596 or mail your correspondence to:

DEA HEADQUARTERS
ATTN: FOI/PA UNIT (SARF)
8701 MORRISSETTE DRIVE
SPRINGFIELD, VIRGINIA 22152

Sincerely,

Katherine L. Myrick, Chief
Freedom of Information/Privacy Act Unit
FOI/Records Management Section

EXHIBIT C



U.S. Department of Justice
Drug Enforcement Administration
FOI/Records Management Section
8701 Morrissette Drive
Springfield, Virginia 22152

Case Number: 14-00009-F

NOV 13 2013

Subject: Information related to the Hemisphere Program

Bruce Friedrich
Electronic Privacy Information Center
1718 Connecticut Ave NW
Suite 200
Washington, DC 20009

Dear Mr. Friedrich:

This letter responds to your Freedom of Information/Privacy Act (FOI/PA) request dated September 25, 2013, addressed to the Drug Enforcement Administration (DEA), Freedom of Information/Privacy Act Unit (SARF), seeking access to information regarding the above subject.

Your request as written does not meet the requirements of the FOIA, 5 U.S.C. § 552 (a)(3)(A), since it does not reasonably describe records and is not filed in accordance with agency rules. The Department of Justice (DOJ) rules, contained at 28 C.F.R. § 16.3(a), provides that "if you are making a request for records about yourself see § 16.41(d) for additional requirements. If you are making a request for records about another individual, either a written authorization signed by that individual permitting disclosure of those records to you or proof that individual is deceased (for example, a copy of a death certificate or an obituary) will help the processing of your request" and 28 C.F.R. § 16.3(b) provides that "you must describe the records in enough detail to enable department personnel to locate them with a reasonable amount of effort" and when possible, your request should include specific information about each record sought such as the date, title or name, author, recipient and subject matter of the record. These specifics are important to determine the extent and scope of the search, and to determine the records that are responsive. DEA can make certain presumptions to overcome some of the deficiencies in your request, but not all of them.

Further, to retrieve the information that you may be seeking requires more specificity. Under the FOIA, an agency is not required to conduct research. DEA maintains several types of records and records systems. For example, in your letter, you are requesting, "*all Hemisphere training modules, request forms, and similar final guidance documents that are used in the day-to-day operation of the program. Any analyses, memos, opinions, or other communications that discuss the legal basis of the program and the privacy impact of the program. Any presentations, analyses, memos, opinions, or other communications for Congress that cover Hemisphere's operations.*" Yet, you have not specified a particular DEA office that you wish searched; or the type of record that would be responsive to your request. Be advised that there are approximately 22 DEA Field Divisions, over 250 domestic offices, and more than 150 Headquarters activities. Since your description did not limit the search to a specific office or area, a vast majority of DEA offices would be tasked to conduct a search of their respective offices for any responsive records pertaining to the subject of your request. As such, your request is overly broad and burdensome.

DEA is a component of the Department of Justice whose primary responsibility is the enforcement of Federal criminal laws related to the illicit trafficking in controlled substances and chemicals, including the Drug Abuse Prevention and Control Act of 1970, 21 U.S.C. § 801 et seq. See 28 C.F.R. § 0.100. DEA maintains several types of records that include criminal and administrative investigatory records, regulatory records, administrative, program records, financial records and personnel records. Under the FOIA an agency is not required to research a topic, create records or engage in a far reaching search of every record system to satisfy a FOIA request.

The information that you request could be maintained in any one of several DEA records systems, including the DEA Investigative Reporting and Filing System (IRFS), DEA Correspondence Files, and/or several field or headquarters offices throughout DEA. Many of these systems are Privacy Act (PA) Systems of Records and the information maintained relates to the activities and actions of individuals. Generally, since our investigative records and systems involve the activities of individuals engaged in the illicit trafficking in controlled substances, the name, date of birth, and social security number are required to locate information, and a release authorization or other information as described in 28 C.F.R. § 16.3(a) is required.

For your information, Congress excluded three discrete categories of law enforcement and national security records from the requirements of the FOIA. See 5 U.S.C. § 552(c) (2006 & Supp. IV 2010). This response is limited to those records that are subject to the requirements of the FOIA. This is a standard notification that is given to all our requesters and should not be taken as an indication that excluded records do, or do not, exist.

To this end, no further action will be initiated on this request until we are in receipt of your reformulated request. If this office does not receive your response within 30 days, DEA will assume that you do not wish to pursue this matter and your request will be administratively closed. Please forward your response to the following address:

DEA HEADQUARTERS
ATTN: FOIA/PA UNIT (SARF)
8701 MORRISSETTE DRIVE
SPRINGFIELD, VIRGINIA 22152

If you have any questions regarding this letter, you may contact FOI Specialist J. Delo on 202-307-7748.

Sincerely,



Katherine L. Myrick, Chief
Freedom of Information/Privacy Act Unit
FOI/Records Management Section

EXHIBIT D

SARF NOV 22 '13 AM 09:26



November 15, 2013

VIA CERTIFIED MAIL

Katherine L. Myrick, Chief
DEA Headquarters
Attn: FOIA/PA Unit (SARF)
8701 Morrisette Dr.
Springfield, VA 22152

1718 Connecticut Ave NW
Suite 200
Washington DC 20009
USA
+1 202 483 1140 (tel)
+1 202 483 1248 (fax)
www.epic.org

Re: Freedom of Information Act Request (Case Number: 14-00009-F)

Dear Ms. Myrick,

This letter constitutes a request under the Freedom of Information Act ("FOIA"), 5 U.S.C. § 552, and is submitted on behalf of the Electronic Privacy Information Center ("EPIC") to the Drug Enforcement Agency ("DEA").

On November 13, EPIC received a letter from your office asking that we reformulate a similar request that was sent to your office on September 25. As suggested in your letter, we spoke with FOIA Specialist Josh Delo, who told us that the documents requested were sufficiently specific, but that we needed to specify which DEA offices would have responsive records. We have done that below.

EPIC seeks records related to the Hemisphere Program, as detailed below.

Background

Earlier this month, the *New York Times* reported on a previously secret government program called "Hemisphere," which has been in operation since at least 2007.¹ Hemisphere allows law enforcement personnel in multiple agencies to access billions of phone records of AT&T customers, as well as any non-customers whose communication is routed through an AT&T switch.² The data is accessed primarily for counternarcotics investigations, but is also used for a variety of other law enforcement activities.³ The program is funded by the DEA and the White House's Office of National Drug Control Policy.⁴

¹ Scott Shane & Colin Moynihan, *Drug Agents Use Vast Phone Trove, Eclipsing N.S.A.'s*, N.Y. Times, Sept. 2, 2013, at A1, also available at http://www.nytimes.com/2013/09/02/us/drug-agents-use-vast-phone-trove-eclipsing-nsas.html?pagewanted=all&_r=0

² Evan Perez, *DEA Program Linked to Vast AT&T Database*, CNN, Sept. 2, 2013, <http://security.blogs.cnn.com/2013/09/02/dea-program-linked-to-vast-at-t-database-documents-show>

³ Shane & Moynihan, *supra* note 1.

⁴ Mike Levine, *DEA Puts Phone Company Inside Government Offices*, ABC News, Sept. 1, 2013, <http://abcnews.go.com/blogs/headlines/2013/09/dea-program-puts-phone-company-inside-government-offices/>

Details of the Hemisphere program are set out in a PowerPoint training presentation.⁵ The PowerPoint explains that Hemisphere supplies “electronic call detail records (CDRs)” in response to both administrative and grand jury subpoenas.⁶ Every day, AT&T adds 4 billion new records to the Hemisphere database.⁷ Hemisphere participants are supplied with training modules⁸ and fill out standardized subpoena request forms.⁹

A government subpoena to AT&T will retrieve CDRs on calls made as recently as one hour before the request was approved, and as far back as 1987.¹⁰ For the period and region covered by the PowerPoint, 96 percent of requests came from either the DEA or DHS.¹¹

Hemisphere is the largest telephone record collection program reported to date.¹² The program includes extensive location information.¹³ Hemisphere allows law enforcement to gather extensive electronic information from U.S. citizens while instructing program participants to “wall off” any reference to Hemisphere in any public document.¹⁴

While all records are stored by a private company,¹⁵ four of that company’s employees are paid by the government.¹⁶ Additionally, the government uses an algorithm, untethered to judicial authority, to determine which phone records to subpoena,¹⁷ raising questions about how often records are retrieved for people not under investigation.¹⁸

Documents Requested

EPIC requests copies of the following agency records from DEA Headquarters and DEA division offices in Atlanta, Houston, Los Angeles, and Washington, D.C.:

- 1) All Hemisphere training modules, request forms, and similar final guidance documents that are used in the day-to-day operation of the program.
- 2) Any analyses, memos, opinions, or other communications that discuss the legal basis of the program.
- 3) Any analyses, memos, opinions, or other communications that discuss the privacy impact of the program.

⁵ Shane & Moynihan, *supra* note 1.

⁶ PowerPoint: *Los Angeles Hemisphere. High Intensity Drug Trafficking Area*, at 2, available at <http://s3.documentcloud.org/documents/782287/database.pdf>

⁷ Perez, *supra* note 2.

⁸ *Id.* at 8.

⁹ *Id.* at 6.

¹⁰ *Id.* at 3.

¹¹ *Id.* at 16.

¹² Shane & Moynihan, *supra* note 1.

¹³ PowerPoint, *supra* note 6, at 3.

¹⁴ PowerPoint, *supra* note 6, at 12.

¹⁵ Gene Johnson & Eileen Sullivan, *Drug Agents Plumb Vast Database of Call Records*, Associated Press, Sept. 3, 2013, <http://www.businessweek.com/ap/2013-09-02/drug-agents-plumb-vast-database-of-call-records>

¹⁶ Perez, *supra* note 2. An ACLU Spokesperson points out that “to the extent that this is a government program, it’s subject to the Fourth Amendment.”

¹⁷ *Id.*

¹⁸ Johnson & Sullivan, *supra* note 15.

- 4) Any presentations, analyses, memos, opinions or other communications for Congress that cover Hemisphere's operations.

Request for Expedited Processing

Expedited processing is justified because the request: 1) is made by an organization "primarily engaged in disseminating information"; and 2) covers information about which there is an "urgency to inform the public about an actual or alleged federal government activity." 5 U.S.C. § 552(a)(6)(E)(v)(II); *Al-Fayed v. CIA*, 254 F.3d 306 (D.C. Cir. 2001).

EPIC is an organization "primarily engaged in disseminating information." *American Civil Liberties Union v. Department of Justice*, 321 F. Supp. 2d 24, 29 n.5 (D.D. Cir. 2004).

There is an "urgency to inform the public" about Hemisphere, which is an "actual government activity." News of the Hemisphere Program broke on the front page of the *New York Times* on September 2¹⁹ and it has also been covered by ABC News,²⁰ NBC News,²¹ Fox News,²² CNN,²³ the *Philadelphia Enquirer*,²⁴ and the Associated Press.²⁵ Internationally, both the *Guardian* of London²⁶ and the *Daily Mail*²⁷ featured stories on the program. Summarizing the view of civil libertarians quoted in these stories, the American Civil Liberties Union explains that "the NSA's untethered snooping is eclipsed by [the Hemisphere Program]... "[A]s with so many of government surveillance programs, Hemisphere raises serious constitutional questions..."²⁸

¹⁹ Shane & Moynihan, *supra* note 1. ("The scale and longevity of the data storage appears to be unmatched by other government programs, including the N.S.A.'s gathering of phone call logs under the Patriot Act ... Daniel C. Richman, a law professor at Columbia ... said the program at least touched on an unresolved Fourth Amendment question: whether mere government possession of huge amounts of private data, rather than its actual use, may trespass on the amendment's requirement that searches be 'reasonable.' Even though the data resides with AT&T, the deep interest and involvement of the government in its storage may raise constitutional issues, he said.")

²⁰ Levine, *supra* note 4. ("Asked whether AT&T customers should have more of an opportunity to respond to subpoenas for their information under Hemisphere, the official noted that AT&T can challenge a subpoena under Hemisphere, just as the company can with subpoenas outside Hemisphere. In those cases, the customer is not immediately aware of the subpoena to challenge it either.")

²¹ Richard Esposito, *DEA phone call database bigger than NSA's*, NBC News, Sept. 2, 2013, <http://investigations.nbcnews.com/news/2013/09/02/20293683-dea-phone-call-database-bigger-than-nsas?lite> ("The pool grows by billions of calls a day, includes information on the location of callers, and is larger than the controversial database maintained by the NSA...").

²² *Drug agents reportedly have access to bigger phone database than NSA's*, Fox News, <http://www.foxnews.com/politics/2013/09/02/drug-agents-reportedly-have-access-to-bigger-phone-database-than-nsa/>

²³ Perez, *supra* note 2. ("The documents surface amid controversy over government surveillance programs ... that collect phone, e-mail and other records in an effort to thwart terror attacks.")

²⁴ *Inquirer Editorial: Data trolling violates rights*, Philadelphia Enquirer, Sept. 5, 2013, http://articles.philly.com/2013-09-05/news/41769068_1_phone-records-phone-call-drug-dealers ("The net [spy agencies] use to troll for information is too wide, and too likely to cause unwarranted violations of Americans' right to privacy. Now comes news that it isn't just the National Security Agency that, in its pursuit of terrorists possibly plotting mayhem, uses this scattershot approach to domestic targets.")

²⁵ Johnson & Sullivan, *supra* note 15. ("The details of the Hemisphere Project come amid a national debate about the federal government's access to phone records, particularly the bulk collection of phone records for national security purposes.")

²⁶ James Ball, *US drug agency partners with AT&T for access to 'vast database' of call records*, The Guardian, Sept. 2, 2013, <http://www.theguardian.com/world/2013/sep/02/nsa-dea-at-t-call-records-access> ("Unlike the controversial call record accesses obtained by the NSA, the data is stored by AT&T, not the government, but officials can access individual's phone records within an hour of an administrative subpoena.")

²⁷ Michael Zennie, *REVEALED: Secret program gives federal agents nearly instant access to BILLIONS of AT&T phone records without a court order*, Daily Mail, Sept. 2, 2013, <http://www.dailymail.co.uk/news/article-2408681/REVEALED-Secret-program-gives-federal-agcnets-nearly-instant-access-BILLIONS-AT-amp-T-phone-records-court-order.html> ("The Times reports that in many cases, no court order or grand jury subpoena is needed to receive these records - meaning that checks and balances on the process are limited or even non-existent.")

²⁸ Ezekiel Edwards, *Drug Agents Have an NSA-Style Spying Problem*, ACLU Blog of Rights, Sept. 4, 2013, <https://www.aclu.org/blog/criminal-law-reform-national-security/drug-agents-have-nsa-style-spying-problem>

The U.S. Congress is currently debating the scope of government surveillance. For example, since June 11, no fewer than fifteen bills that that would limit the scope of government surveillance have been introduced in the Congress.²⁹ Most recently, on September 20, House Select Committee on Intelligence senior member Rep. Adam Schiff introduced the “Ensuring Adversarial Process in the FISA Court Act.” The goal of the legislation according to Rep. Schiff is to protect “the Fourth Amendment and privacy concerns of ordinary Americans.”³⁰ Last month, two surveillance-inspired bills were introduced that focus on “constitutional and statutory requirements to safeguard individual rights to privacy and liberty.”³¹ Senator Tom Udall, explaining his decision to co-sponsor both bills, stated that “Americans deserve the assurance that their civil liberties are not being swept aside behind closed doors.”³²

Just last month, President Obama acknowledged the need for “clear safeguards to prevent abuse and protect the rights of the American people”³³ with regard to surveillance programs. The President announced specific steps that he was taking to “move the debate [on surveillance] forward.”³⁴ Specifically, he stated that he would: 1) work with Congress to reform the section of the Patriot Act that collects telephone records to add “additional safeguards against abuse”; 2) “direct[] the intelligence community to make public as much information about these programs as possible”; and 3) create “a high-level group of outside experts to review our entire intelligence and communications technologies.”³⁵ The group’s mandate is to “make sure that there absolutely is no abuse in terms of how these surveillance technologies are used.”³⁶ The President explained that the group will “provide an interim report in 60 days and a final report by the end of this year, so that we can move forward with a better understanding of how these programs impact our security, our privacy, and our foreign policy.”³⁷

In order to comment on the privacy and other issues raised by Hemisphere, which are of significant and immediate national concern, the public should have access to information about the scope of and legal authority for the program, as well as how call detail records are used, the adequacy of privacy safeguards, and other privacy implications.

Request for News Media Fee Status

²⁹ H.R.2399, LIBERT-E Act; H.R.2440, FISA Court in the Sunshine Act of 2013; H.R.2475, Ending Secret Law Act; H.R.2586, FISA Court Accountability Act; H.R.2684, Telephone Surveillance Accountability Act of 2013; H.R.2736, Government Surveillance Transparency Act of 2013; H.R.2761, Presidential Appointment of FISA Court Judges Act; H.R.2818, Surveillance State Repeal Act; H.R.2849, Privacy Advocate General Act of 2013; Ensuring Adversarial Process in the FISA Court Act; S.1130, Ending Secret Law Act; S.1215, FISA Accountability and Privacy Protection Act of 2013; S.1452, Surveillance Transparency Act of 2013; S.1460, FISA Judge Selection Reform Act of 2013; S.1467, FISA Court Reform Act of 2013.

³⁰ Press Release, Office of Rep. Adam Schiff, *Rep. Schiff Introduces Legislation to Reform FISA Court and Allow Independent, Public Interest Advocate* (Sept. 20, 2013) (available at <https://schiff.house.gov/press-releases/rep-schiff-introduces-legislation-to-reform-fisa-court-and-allow-independent-public-interest-advocate/>).

³¹ Press Release, Office of Sen. Richard Blumenthal, *Blumenthal Unveils Major Legislation to Reform FISA Courts* (Aug. 1, 2013) (available at <http://www.blumenthal.senate.gov/newsroom/press/release/blumenthal-unveils-major-legislation-to-reform-fisa-courts>).

³² *Id.*
³³ President Barack Obama, *Remarks by the President in a Press Conference* (Aug. 9, 2013) (available at <http://www.whitehouse.gov/the-press-office/2013/08/09/remarks-president-press-conference>).

³⁴ *Id.*

³⁵ *Id.*

³⁶ *Id.*

³⁷ *Id.*

EPIC is a representative of the news media. *EPIC v. Dep't of Defense*, 241 F.Supp. 2d 5 (D.D.C. 2003). Based on our status as a news media requester, we are entitled to receive the requested records with only duplication fees assessed.

Further, because disclosure of this information will "contribute significantly to public understanding of the operations or activities of the government," as described above, any duplication fees should be waived. 5 U.S.C. § 552(a)(4)(A)(iii).

Thank you for your consideration of our request. As provided in 6 C.F.R. § 5.5(d)(4), we will anticipate your determination on our request for expedited processing within 10 business days. For questions regarding this request, we can be contacted at 202-483-1140, x 120, or FOIA@epic.org.

Sincerely,

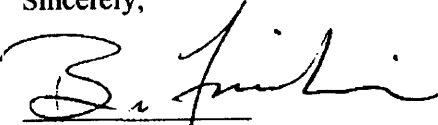

Bruce Friedrich
EPIC Extern



Julia Horwitz
EPIC Open Government Coordinator

EXHIBIT E



U.S. Department of Justice
Drug Enforcement Administration
FOI/Records Management Section
8701 Morrissette Drive
Springfield, Virginia 22152

JUL 21 2014

Case Number: 14-00009-F

Subject: INFORMATION PERTAINING TO THE HEMISPHERE PROGRAM

Bruce Friedrich
Electronic Privacy Information Center
1718 Connecticut Ave NW
Suite 200
Washington, DC 20009

Dear Mr. Friedrich:

This letter responds to your Freedom of Information/Privacy Act (FOI/PA) request dated September 25, 2013, addressed to the Drug Enforcement Administration (DEA), Freedom of Information/Privacy Act Unit (SARF), seeking access to information regarding the above subject.

The processing of your request identified certain materials that will be released to you. Portions not released are being withheld pursuant to the Freedom of Information Act, 5 U.S.C. § 552, and/or the Privacy Act, 5 U.S.C. § 552a. Please refer to the list enclosed with this letter that identifies the authority for withholding the deleted material, which is indicated by a mark appearing in the block next to the exemption. An additional enclosure with this letter explains these exemptions in more detail. The documents are being forwarded to you with this letter.

The rules and regulations of the Drug Enforcement Administration applicable to Freedom of Information Act requests are contained in the Code of Federal Regulations, Title 28, Part 16, as amended. They are published in the Federal Register and are available for inspection by members of the public.

For your information, Congress excluded three discrete categories of law enforcement and national security records from the requirements of the FOIA. See 5 U.S.C. § 552(c) (2006 & Supp. IV 2010). This response is limited to those records that are subject to the requirements of the FOIA. This is a standard notification that is given to all our requesters and should not be taken as an indication that excluded records do, or do not, exist.

Case Number: 14-00009-F

Page 2

If you are not satisfied with the response to this request, you may administratively appeal by writing to the Director, Office of Information Policy, United States Department of Justice, Suite 11050, 1425 New York Avenue, NW, Washington, DC 20530-0001, or you may submit an appeal through OIP's eFOIA portal at <http://www.justice.gov/oip/efoia-portal.html>. Your appeal must be received within sixty (60) days from the date of this letter. If you submit your appeal by mail, both the letter and the envelope should be clearly marked "Freedom of Information Act Appeal."

If you have any questions regarding this letter, you may contact Government Information Specialist J. Delo on 202-307-7748.

Sincerely,

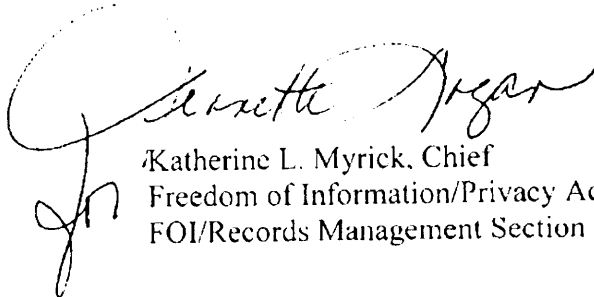

Katherine L. Myrick, Chief
Freedom of Information/Privacy Act Unit
FOI/Records Management Section

Enclosures

Number of pages withheld: 103

Number of pages released: 216

APPLICABLE SECTIONS OF THE FREEDOM OF INFORMATION AND/OR PRIVACY ACT:

**Freedom of Information Act
5 U.S.C. 552**

**Privacy Act
5 U.S.C. 552a**

- (b)(1) (b)(5) (b)(7)(C)
- (b)(2) (b)(6) (b)(7)(D)
- (b)(3) (b)(7)(A) (b)(7)(E)
- (b)(4) (b)(7)(B) (b)(7)(F)

- (d)(5) (k)(2)
- (j)(2) (k)(5)
- (k)(1) (k)(6)

FREEDOM OF INFORMATION ACT
SUBSECTIONS OF TITLE 5, UNITED STATES CODE, SECTION 552

- (b)(1) Information which is currently and properly classified pursuant to Executive Order in the interest of the national defense or foreign policy.
- (b)(2) Materials related solely to the internal rules and practices of DEA.
- (b)(3) Information specifically exempted from disclosure by another federal statute.
- (b)(4) Privileged or confidential information obtained from a person, usually involving commercial or financial matters.
- (b)(5) Inter-agency or intra-agency documents which are subject to a privilege, such as documents the disclosure of which would have an inhibitive effect upon the development of policy and administrative direction, or which represent the work product of an attorney, or which reflect confidential communications between a client and an attorney.
- (b)(6) Materials contained in sensitive records such as personnel or medical files, the disclosure of which would constitute a clearly unwarranted invasion of personal privacy.
- (b)(7) Records or information compiled for law enforcement purposes, but only to the extent that the production of such law enforcement records or information (A) could reasonably be expected to interfere with enforcement proceedings; (B) would deprive a person of a right to a fair trial or an impartial adjudication; (C) could reasonably be expected to constitute an unwarranted invasion of personal privacy; (D) could reasonably be expected to disclose the identity of a confidential source, including a State, local or foreign agency or authority or any private institution which furnished information on a confidential basis; and, in the case of a record or information compiled by a criminal law enforcement authority in the course of a criminal investigation, or by an agency conducting a lawful national security intelligence investigation, information furnished by a confidential source; (E) would disclose techniques and procedures for law enforcement investigations or prosecutions or would disclose guidelines for law enforcement investigations or prosecutions if such disclosure could reasonably be expected to risk circumvention of the law, or (F) could reasonably be expected to endanger the life or physical safety of any individual.

PRIVACY ACT
SUBSECTIONS OF TITLE 5, UNITED STATES CODE, SECTION 552a

- (d)(5) Materials compiled in reasonable anticipation of a civil action or proceeding.
- (j)(2) Material reporting investigative efforts pertaining to the enforcement of criminal law including efforts to prevent, control, or reduce crime or apprehend criminals.
- (k)(1) Information which is currently and properly classified pursuant to Executive Order in the interest of the national defense or foreign policy.
- (k)(2) Material compiled during civil investigations for law enforcement purposes.
- (k)(5) Investigatory material compiled solely for the purpose of determining suitability, eligibility, or qualifications for Federal civilian employment or for access to classified information, the disclosure of which would reveal the identity of the person who furnished information pursuant to an express promise that his identity would be held in confidence, or pursuant to an implied promise of confidentiality if such information was furnished prior to September 27, 1975.
- (k)(6) The substance of tests used to determine individual qualifications for appointment or promotion in Federal Government Service.



Hemisphere Project Request Form

Please Fax When Complete

7E-1

HRC Fax : (b)(7)(A),(b)(7)(E)

HIGH INTENSITY DRUG TRAFFICKING AREA
Office of National Drug Control Policy

WASHINGTON/BALTIMORE HIDTA

Master Case Number:	<input type="text"/>	Priority:	<input type="text"/>	Current Date:	2014-05-29 10:48:48
----------------------------	----------------------	------------------	----------------------	----------------------	---------------------

HIDTA Point of Contact Name: **Email Results To:**

<input type="text"/>	<input type="text"/>
----------------------	----------------------

POC Phone Number:

Email Notification Of Completion To:

<input type="text"/>	<input type="text"/>
----------------------	----------------------

Requestor Name:

Email Results To:

<input type="text"/>	<input type="text"/>
----------------------	----------------------

Requestor Phone Number:

Email Notification Of Completion To:

<input type="text"/>	<input type="text"/>
----------------------	----------------------

DTO Name (if applicable):

Case Name (if applicable):

<input type="text"/>	<input type="text"/>
----------------------	----------------------

HIDTA Initiative: **HIDTA Initiative OR Law Enforcement Agency:**

Yes No

Squad Name:

Time Zone Results Requested In:

(b)(7)(A),(b)(7)(E)

7E-2

Phone Number	Priority	Date Range	
<input data-bbox="265 321 475 373" type="text"/>	<input data-bbox="530 321 865 373" type="text"/>	<input data-bbox="915 321 1063 373" type="text"/>	<input data-bbox="1113 321 1257 373" type="text"/>
<input data-bbox="265 415 475 468" type="text"/>	<input data-bbox="530 415 865 468" type="text"/>	<input data-bbox="915 415 1063 468" type="text"/>	<input data-bbox="1113 415 1257 468" type="text"/>
<input data-bbox="265 510 475 562" type="text"/>	<input data-bbox="530 510 865 562" type="text"/>	<input data-bbox="915 510 1063 562" type="text"/>	<input data-bbox="1113 510 1257 562" type="text"/>
<input data-bbox="265 604 475 657" type="text"/>	<input data-bbox="530 604 865 657" type="text"/>	<input data-bbox="915 604 1063 657" type="text"/>	<input data-bbox="1113 604 1257 657" type="text"/>
<input data-bbox="265 699 475 751" type="text"/>	<input data-bbox="530 699 865 751" type="text"/>	<input data-bbox="915 699 1063 751" type="text"/>	<input data-bbox="1113 699 1257 751" type="text"/>
<input data-bbox="265 793 475 846" type="text"/>	<input data-bbox="530 793 865 846" type="text"/>	<input data-bbox="915 793 1063 846" type="text"/>	<input data-bbox="1113 793 1257 846" type="text"/>
<input data-bbox="265 888 475 940" type="text"/>	<input data-bbox="530 888 865 940" type="text"/>	<input data-bbox="915 888 1063 940" type="text"/>	<input data-bbox="1113 888 1257 940" type="text"/>
<input data-bbox="265 982 475 1035" type="text"/>	<input data-bbox="530 982 865 1035" type="text"/>	<input data-bbox="915 982 1063 1035" type="text"/>	<input data-bbox="1113 982 1257 1035" type="text"/>
<input data-bbox="265 1077 475 1129" type="text"/>	<input data-bbox="530 1077 865 1129" type="text"/>	<input data-bbox="915 1077 1063 1129" type="text"/>	<input data-bbox="1113 1077 1257 1129" type="text"/>
<input data-bbox="265 1171 475 1224" type="text"/>	<input data-bbox="530 1171 865 1224" type="text"/>	<input data-bbox="915 1171 1063 1224" type="text"/>	<input data-bbox="1113 1171 1257 1224" type="text"/>
<input data-bbox="265 1266 475 1318" type="text"/>	<input data-bbox="530 1266 865 1318" type="text"/>	<input data-bbox="915 1266 1063 1318" type="text"/>	<input data-bbox="1113 1266 1257 1318" type="text"/>
<input data-bbox="265 1360 475 1413" type="text"/>	<input data-bbox="530 1360 865 1413" type="text"/>	<input data-bbox="915 1360 1063 1413" type="text"/>	<input data-bbox="1113 1360 1257 1413" type="text"/>
<input data-bbox="265 1455 475 1507" type="text"/>	<input data-bbox="530 1455 865 1507" type="text"/>	<input data-bbox="915 1455 1063 1507" type="text"/>	<input data-bbox="1113 1455 1257 1507" type="text"/>
<input data-bbox="265 1549 475 1602" type="text"/>	<input data-bbox="530 1549 865 1602" type="text"/>	<input data-bbox="915 1549 1063 1602" type="text"/>	<input data-bbox="1113 1549 1257 1602" type="text"/>
<input data-bbox="265 1644 475 1696" type="text"/>	<input data-bbox="530 1644 865 1696" type="text"/>	<input data-bbox="915 1644 1063 1696" type="text"/>	<input data-bbox="1113 1644 1257 1696" type="text"/>
<input data-bbox="265 1738 475 1791" type="text"/>	<input data-bbox="530 1738 865 1791" type="text"/>	<input data-bbox="915 1738 1063 1791" type="text"/>	<input data-bbox="1113 1738 1257 1791" type="text"/>
<input data-bbox="265 1833 475 1885" type="text"/>	<input data-bbox="530 1833 865 1885" type="text"/>	<input data-bbox="915 1833 1063 1885" type="text"/>	<input data-bbox="1113 1833 1257 1885" type="text"/>
<input data-bbox="265 1927 475 1980" type="text"/>	<input data-bbox="530 1927 865 1980" type="text"/>	<input data-bbox="915 1927 1063 1980" type="text"/>	<input data-bbox="1113 1927 1257 1980" type="text"/>
<input data-bbox="265 2022 475 2074" type="text"/>	<input data-bbox="530 2022 865 2074" type="text"/>	<input data-bbox="915 2022 1063 2074" type="text"/>	<input data-bbox="1113 2022 1257 2074" type="text"/>

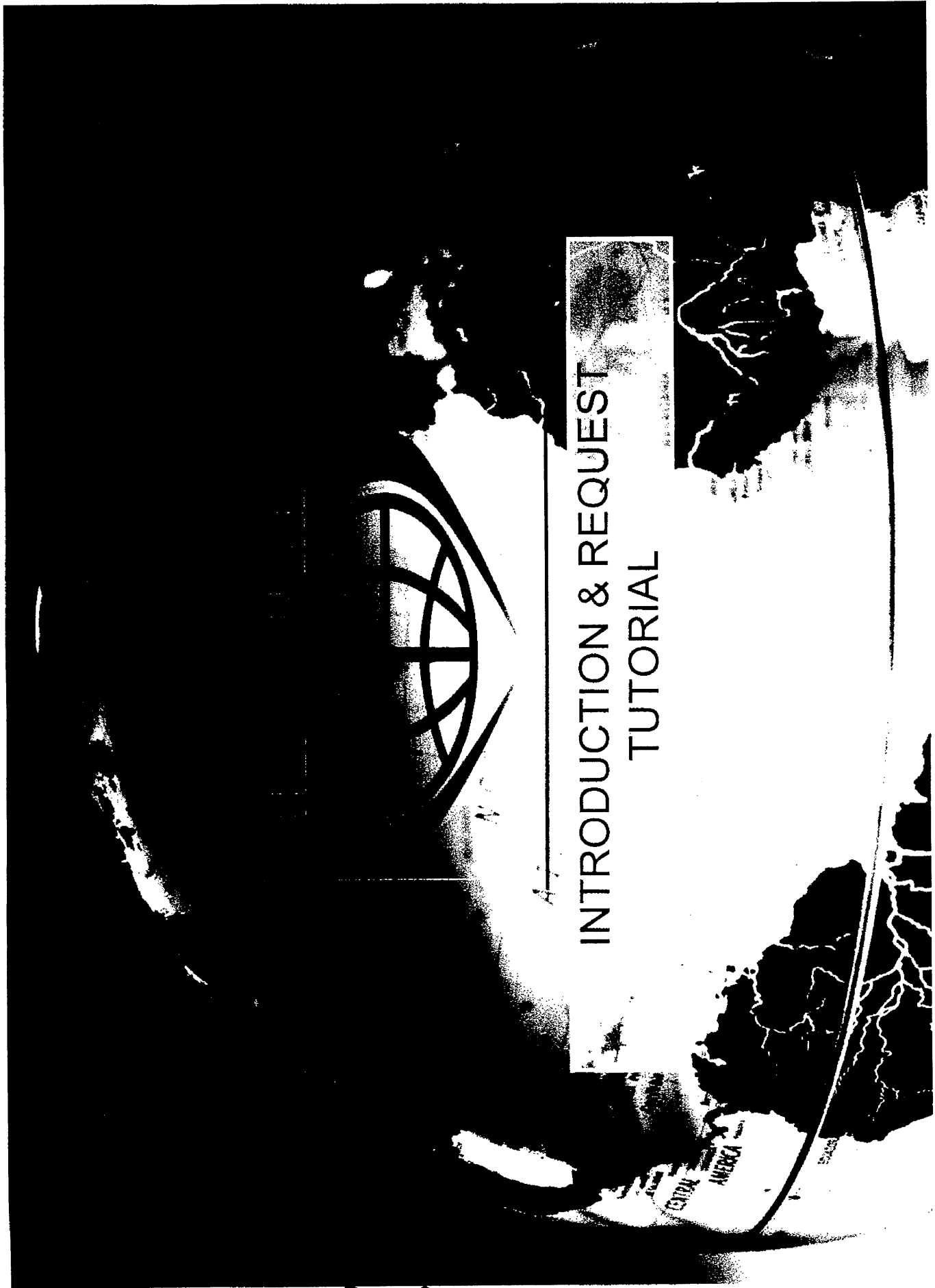

INTRODUCTION & REQUEST
TUTORIAL

(b)(7)(A), (b)(7)(D), (b)(7)(E)

[What is Hemisphere?]

- The Hemisphere Project is a *law enforcement sensitive* subpoena compliance program funded by HIDTA/ONDSCP

--	--	--

7E-3

7E-4

7E-2

7E-4

(b)(7)(A), (b)(7)(E), (b)(7)(F)

[REDACTED] Process

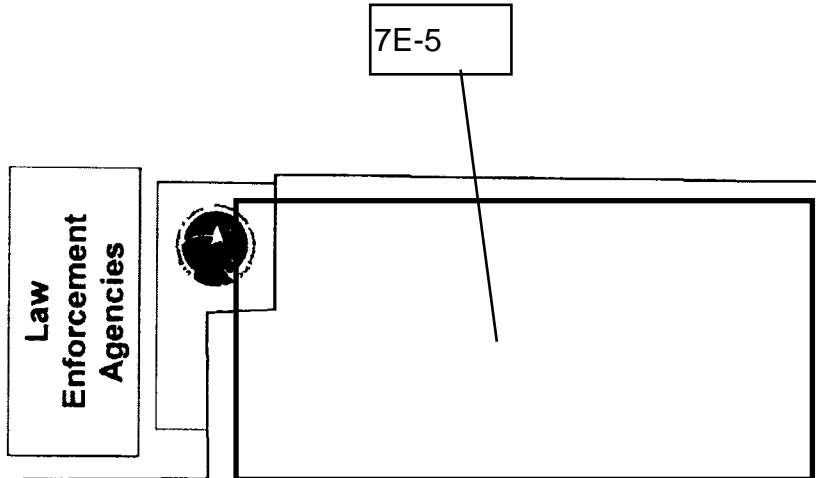

7E-4

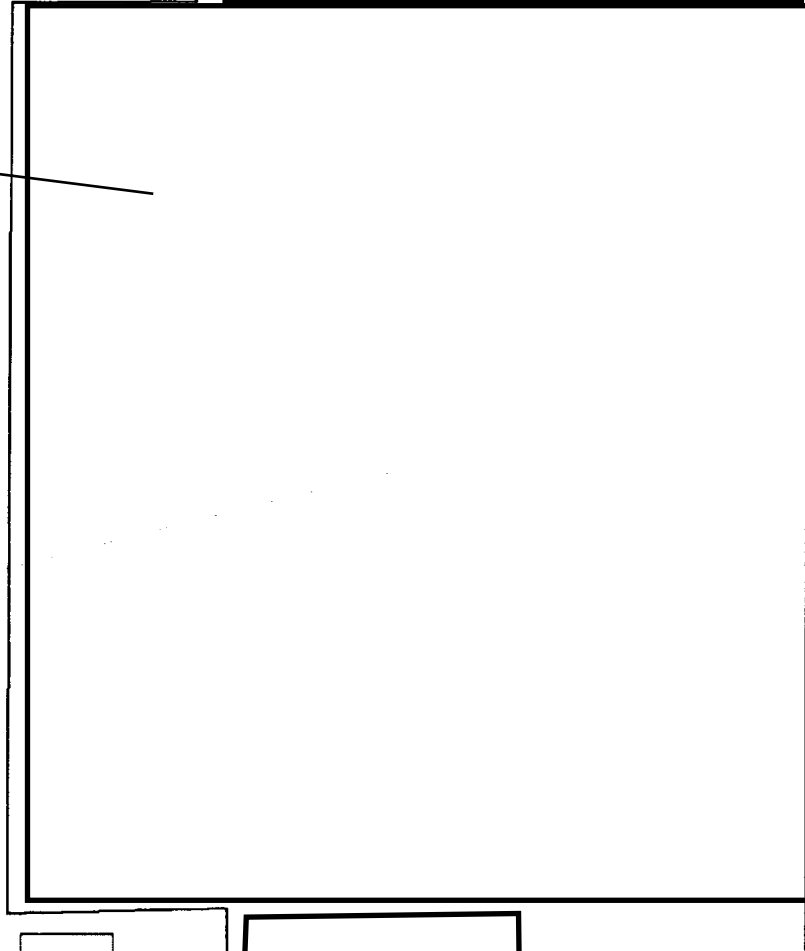

Law Enforcement Agencies

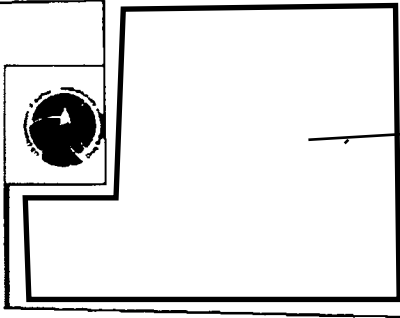

Agencies Generate Request Forms and Subpoenas

7E-5

]

7D-1, 7E-6

Hemisphere

(b)(7)(A), (b)(7)
(D), (b)(7)(E)

[

7E-3

7E-4

6

What is Hemisphere?

(b)(7)(A), (b)(7)(D), (b)(7)(E)

(b)(7)(A), (b)(7)(D), (b)(7)(E)

HEMISPHERE REQUEST FORM-



Hemisphere

include:

7E-4

7E-3

7E-2

7

7E-5

]

7E-3

7E-7

∞

[Redacted]

[Redacted]

[Redacted]

7E-4

Hemisphere

(b)(7)(A), (b)(7)(D), (b)(7)(E)

]

Hemisphere

(b)(7)(A), (b)(7)(D), (b)(7)(E)

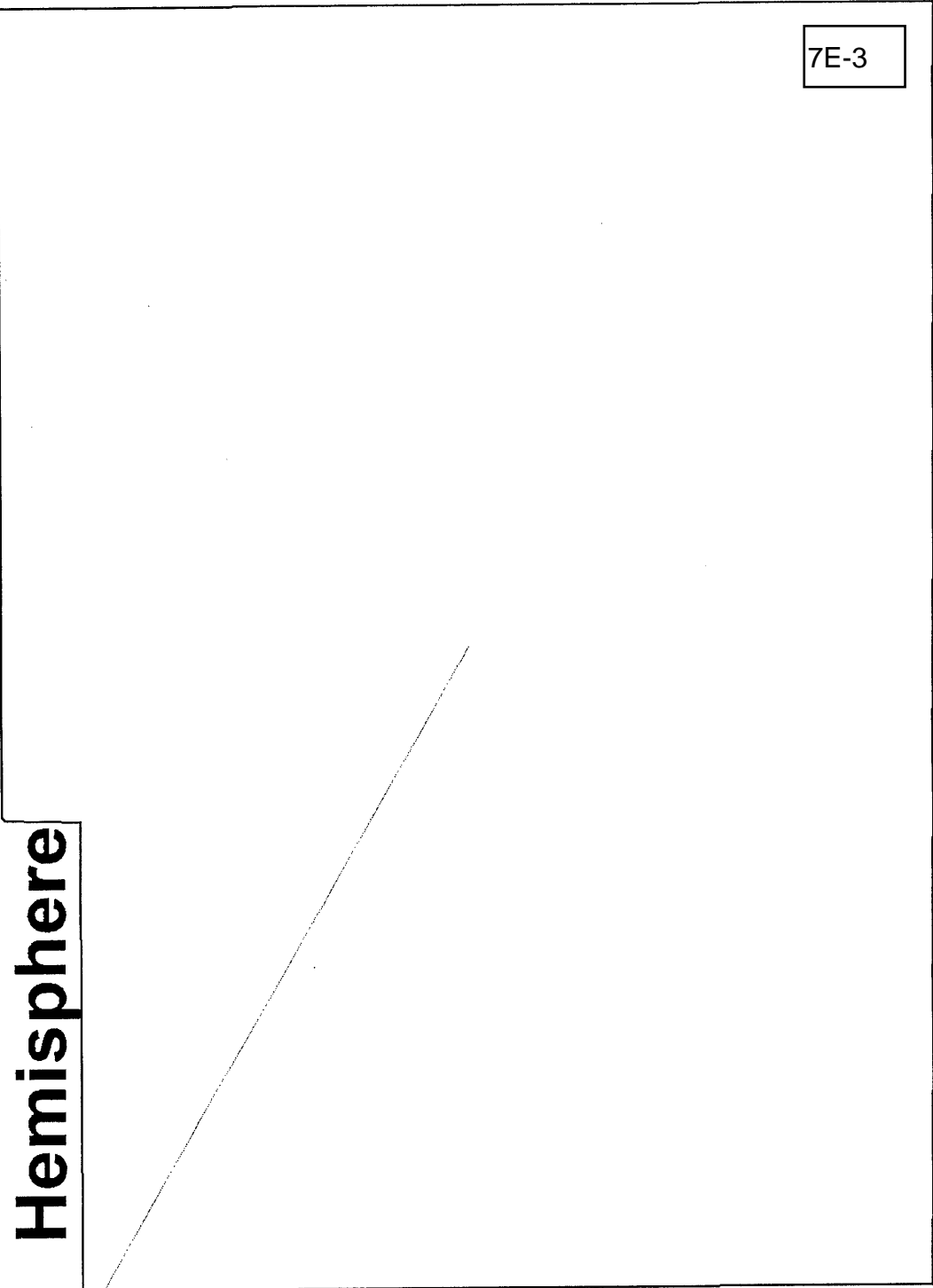

7E-3

[

[Submitting your Request]

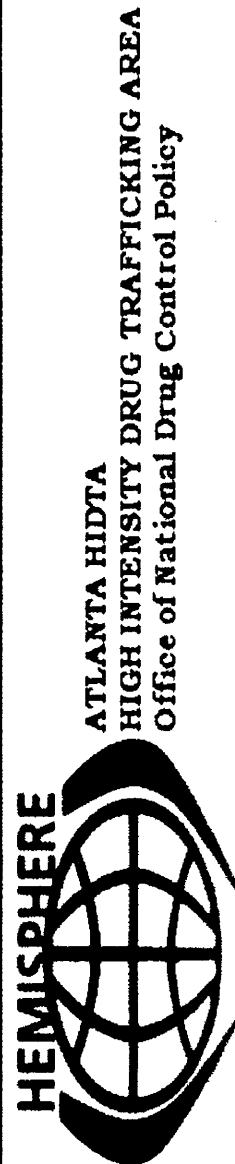

[Submitting your Request]

(b)(7)(A), (b)(7)(E)

7E-4

All Hemisphere requesters . . .

- Must protect the HEMISPHERE Program

HEMISPHERE

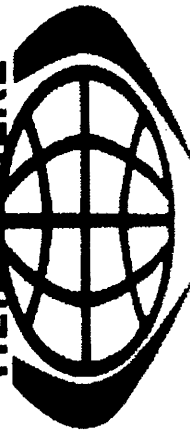

**ATLANTA HIDTA
HIGH INTENSITY DRUG TRAFFICKING AREA
Office of National Drug Control Policy**

(b)(6), (b)(7)(C), (b)(7)(F)

ATLANTA HEMISPHERE POC'S

]

6-1, 7C-1, 7E-8, 7F-1

7E-1

]

[Subpoenas

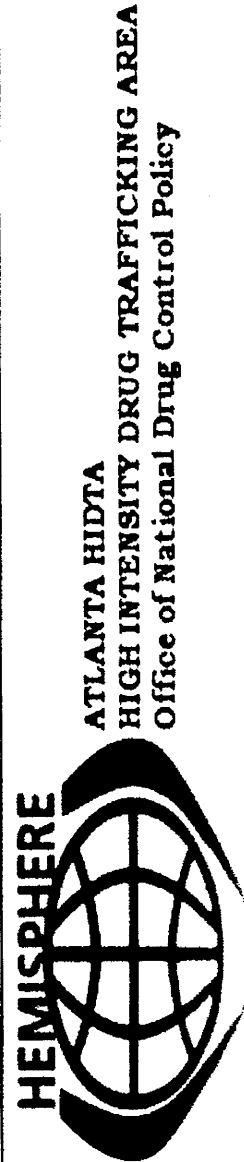

(b)(6), (b)(7)(A), (b)(7)(C), (b)(7)(D), (b)(7)(E), (b)(7)(F)

HEMISPHERE Subpoena

Language

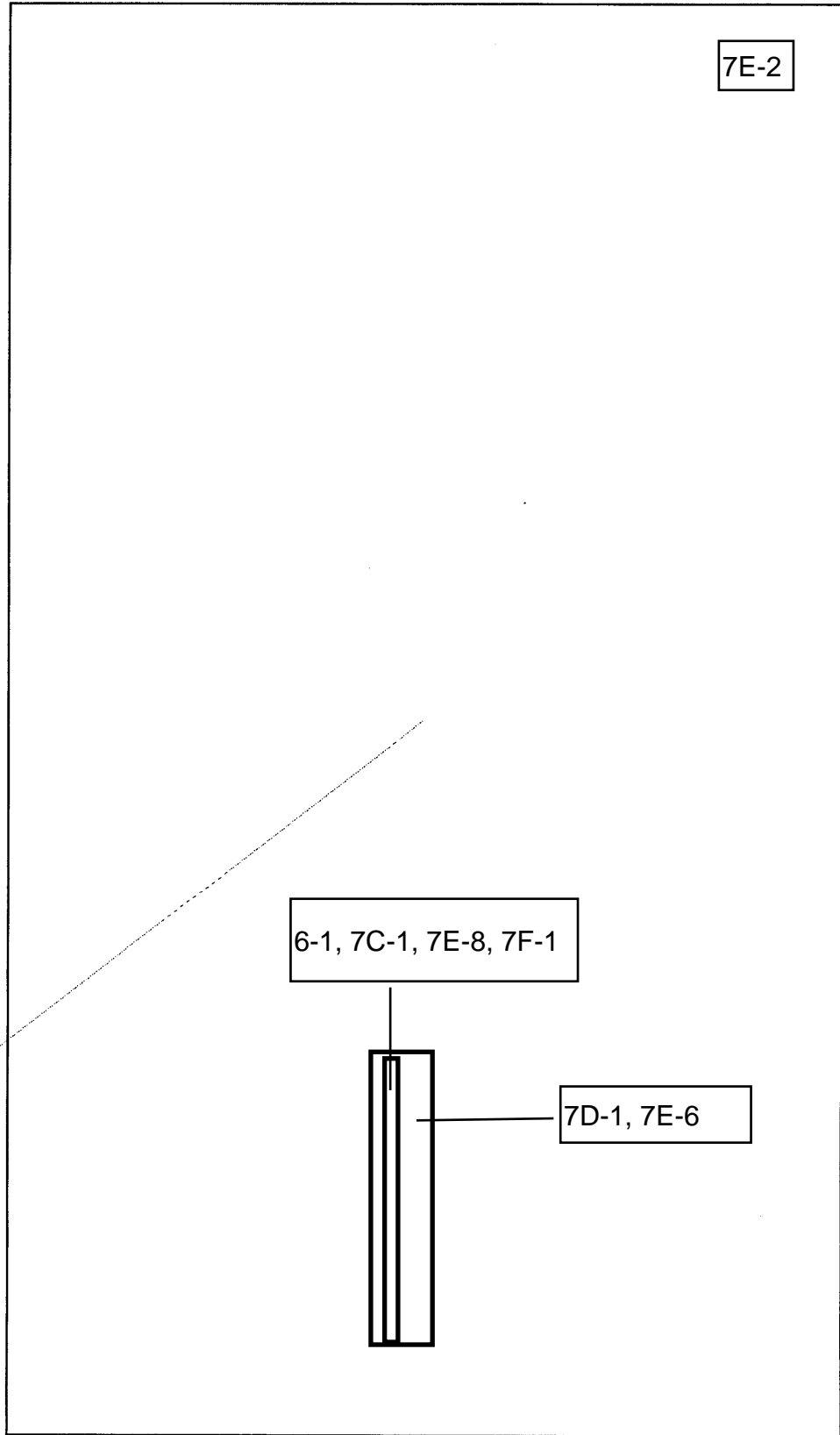

14

(b)(7)(A), (b)(7)(D), (b)(7)(E), (b)(7)(F)

[HEMISPHERE Subpoena Recipient]

**All Hemisphere subpoenas should have the following
in the recipient/address section...**

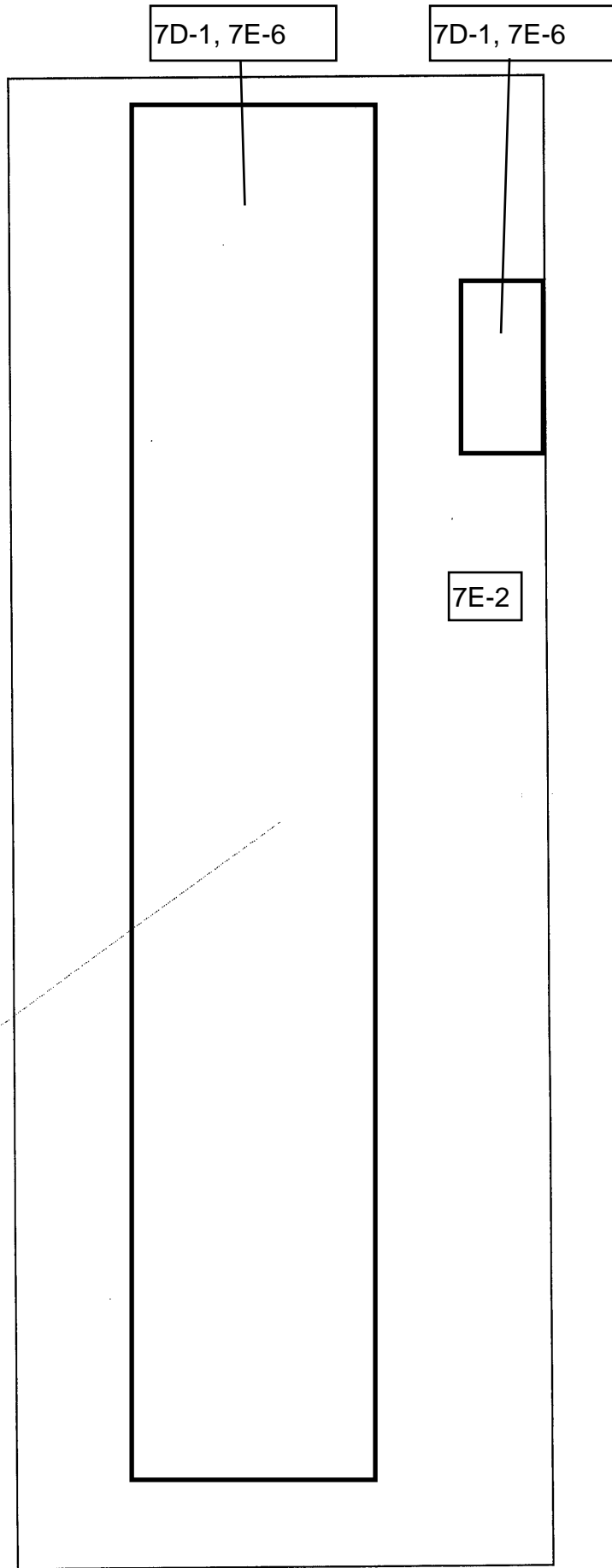

(b)(7)(A), (b)(7)(E)

HEMISPHERE Subpoena

Language

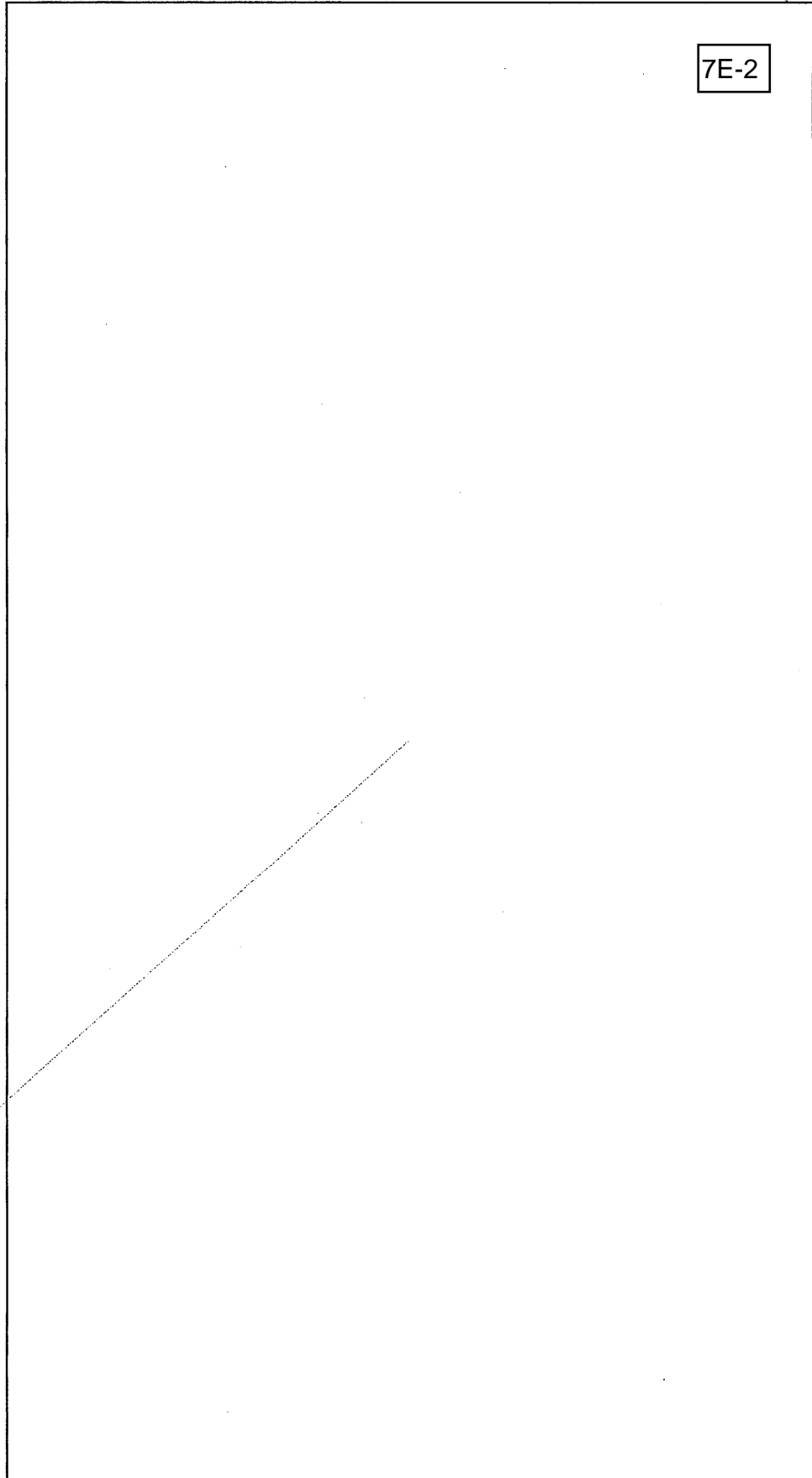

7E-2

16

(b)(6), (b)(7)(A), (b)(7)(C), (b)(7)(D), (b)(7)(E), (b)(7)(F)

HEMISPHERE Subpoena Date Range

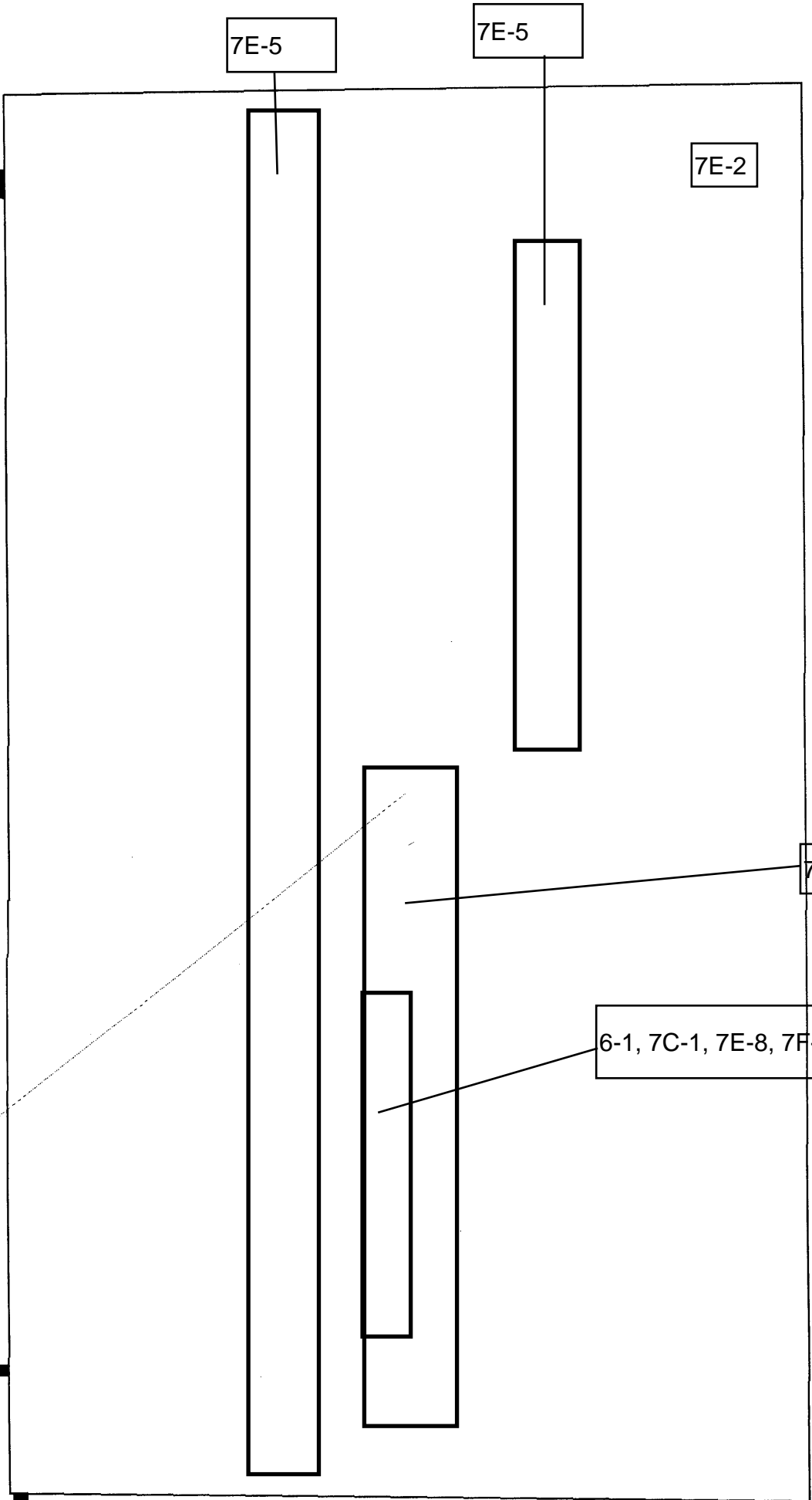

7E-2

HEMISPHERE

(b)(7)(A), (b)(7)(D), (b)(7)(E)

]

[Sample Subpoenas



**ATLANTA HIDTA
HIGH INTENSITY DRUG TRAFFICKING AREA
Office of National Drug Control Policy**

DEA

7D-7E-6

(b)(6), (b)(7)(A), (b)(7)(C), (b)(7)(D), (b)(7)(E), (b)(7)(F)

**U.S. DEPARTMENT OF JUSTICE/DRUG ENFORCEMENT ADMINISTRATION
SUBPOENA**

7E-2

6-1, 7C-1, 7E-8, 7F-1

7D-7E-6

7E-2

7D-1, 7E-6

6-1, 7C-1, 7E-8, 7F-

7E-

7E-5

**United States District Court
District of Maryland**

AO 110 (Rev. 12/89) - U.S. DISTRICT COURT (Rev. 1/2005)

(b) (6), (b) (7)(A), (b) (7)(B), (b) (7)(D), (b) (7)(E), (b) (7)(F)

7E-2

7E-5

6-1, 7C-1, 7E-8, 7F-1

7D-1, 7E-6

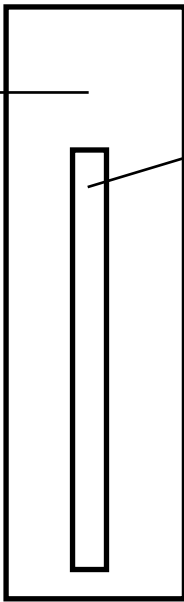

(b)(6), (b)(7)(A), (b)(7)(C), (b)(7)(D), (b)(7)(E), (b)(7)(F)

OTHER

(b)(7)(A), (b)(7)(C), (b)(7)(D), (b)(7)(E), (b)(7)(F)

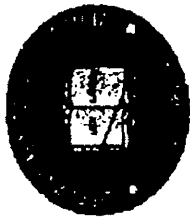

DEPARTMENT DE JUSTICIA
SAN JUAN, PUERTO RICO

SUSPOENA

7D-1, 7E-6

7E-5

7E-2

(b)(6), (b)(7)(A), (b)(7)(C), (b)(7)(D), (b)(7)(E), (b)(7)(F)

**IN THE CIRCUIT COURT OF THE NINTH JUDICIAL CIRUCIT
IN AND FOR ORANGE COUNTY, FLORIDA**

OTHER

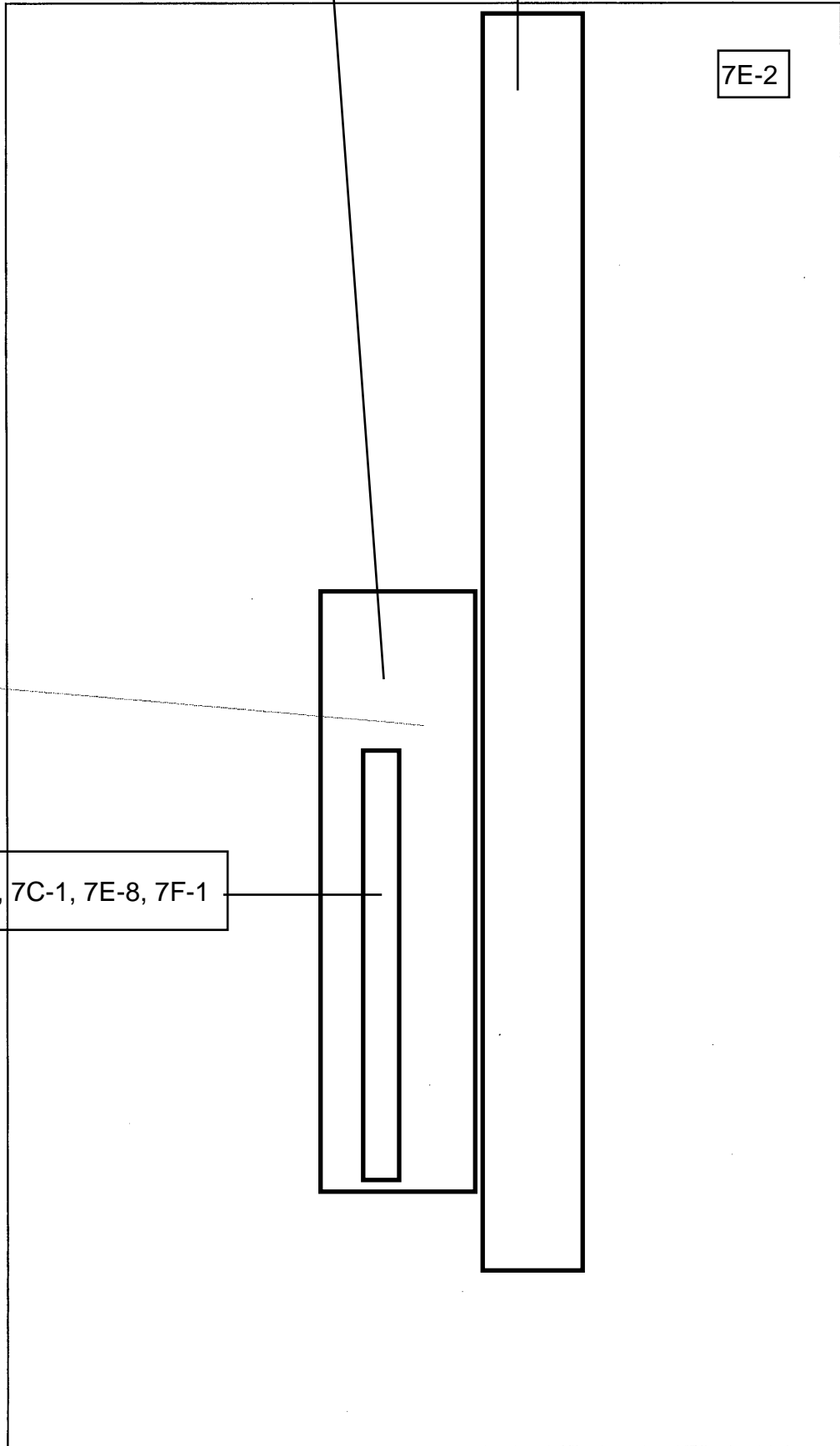

7D-1, 7E-6

7E-5

7E-2

6-1, 7C-1, 7E-8, 7F-1

HEMISPHERE Request Form

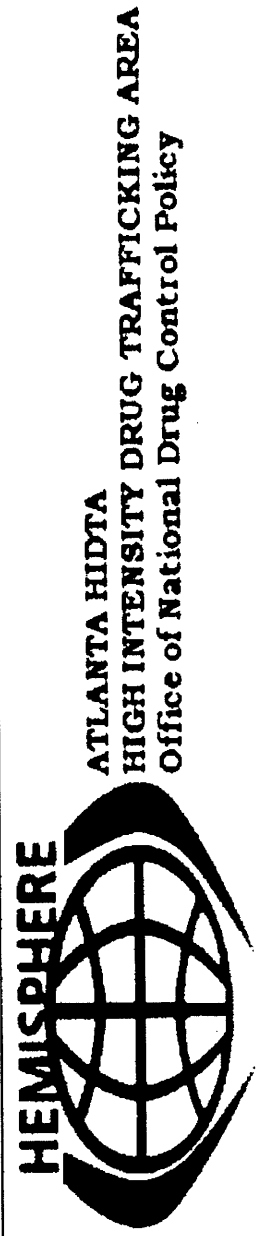

(b)(7)(A), (b)(7)(D), (b)(7)(E)

HEMISPHERE REQUEST FORM- PRIORITY RATING

Priority section: This section determines the urgency level of the request

7E-9

7E-2

7E-3

7E-3

7E-2

(b)(7)(A), (b)(7)(C), (b)(7)(D), (b)(7)(E)



Hemisphere

(b)(7)(A), (b)(7)(D), (b)(7)(E)

7E-2

7E-3

7E-3

(7)(A), (b)(7)(D), (b)(7)(E)

7E-3

b)(7)(A), (b)(7)(D), (b)(7)(E)

7E-3

7E-7

6-1, 7C-1, 7E-8, 7F-1

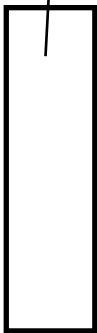

(b)(7)(A), (b)(7)(C), (b)(7)(D), (b)(7)(E), (b)(7)(F)

7E-3

7E-7

7E-1

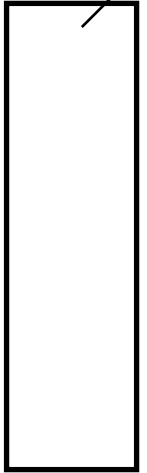

6-1, 7C-1, 7E-8, 7F-1

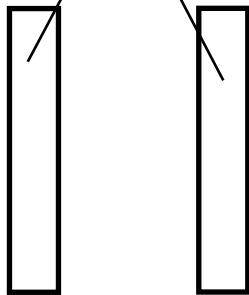

b)(6), (b)(7)(A), (b)(7)(C), (b)(7)(D), (b)(7)(E), (b)(7)(F)

[
HEMISPHERE
]

Any
Questions?

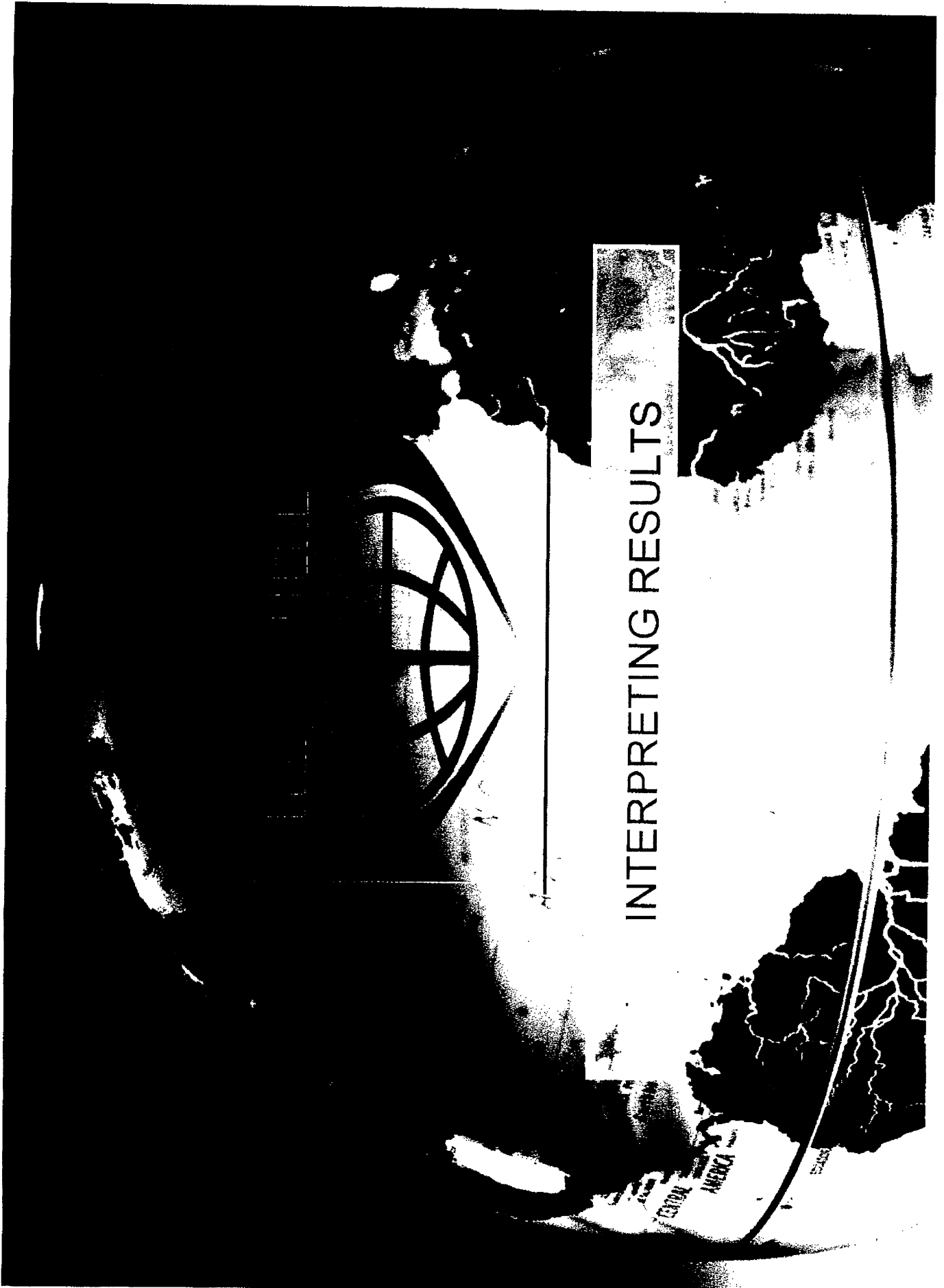

INTERPRETING RESULTS

CENTRAL AMERICA

Wireless Coverage Areas in the U.S.

7D-1, 7E-6

(b)(7)(A), (b)(7)(D)

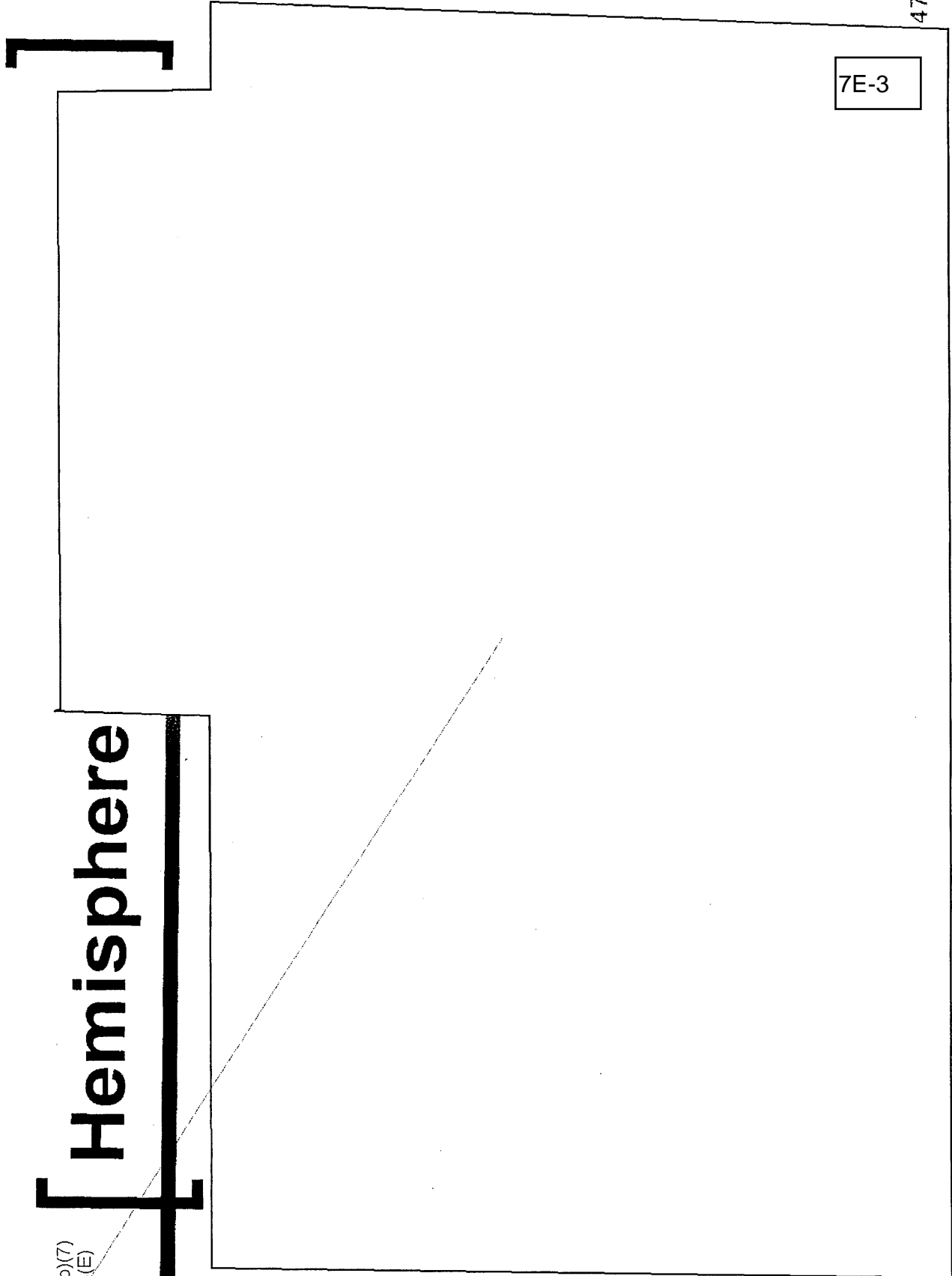

(b)(7)(A), (b)(7)(D), (b)(7)(E)

Hemisphere

Receiving your Request Results

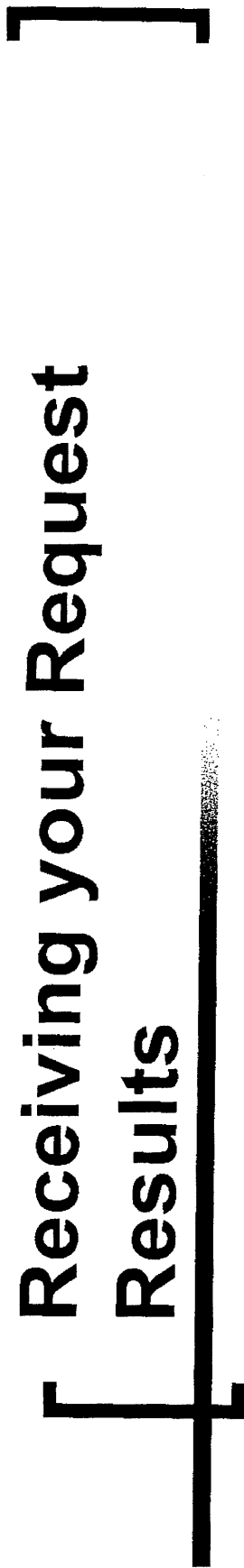

ATLANTA HIDTA
HIGH INTENSITY DRUG TRAFFICKING AREA
Office of National Drug Control Policy

7E-3

49

]

Results Breakdown

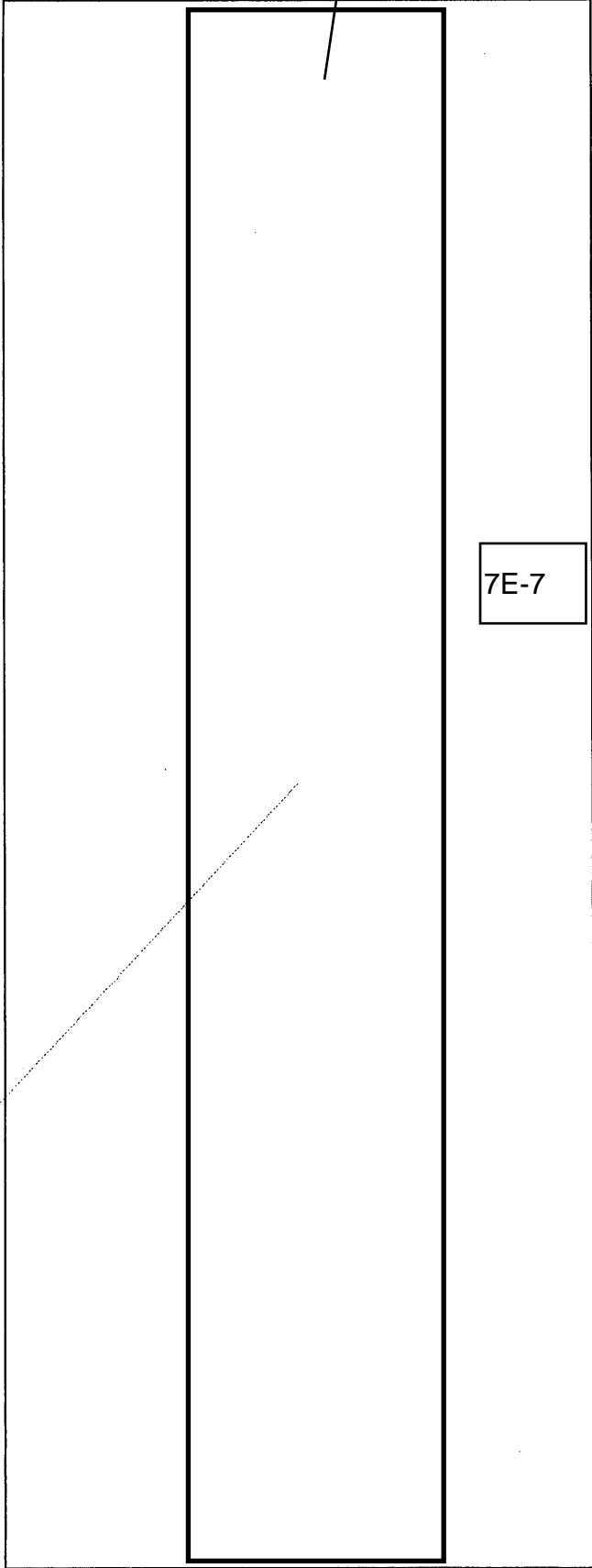

(b)(7)(A), (b)(7)(D), (b)(7)(E)

[

7E-7

6-1, 7C-1, 7E-8, 7F-1

[Redacted]

(b)(7)(A); (b)(7)(C); (b)(7)(D); (b)(7)(E); (b)(7)(F)

]

7E-7

[

(b)(7)(A), (b)(7)(E)



ATLANTA HIDTA
HIGH INTENSITY DRUG TRAFFICKING AREA
Office of National Drug Control Policy

7E-3

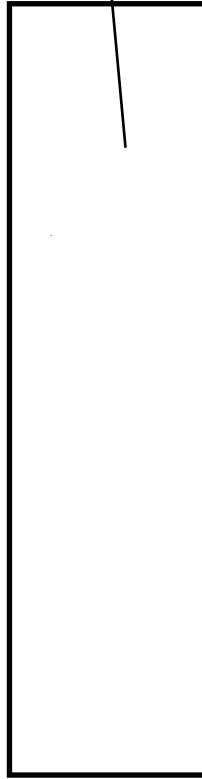

7E-7

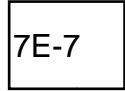

7D-1, 7E-6

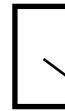

6-1, 7C-1, 7E-8, 7F-1

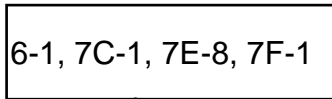

(b)(7)(A), (b)(7)(C), (b)(7)(D), (b)(7)(E), (b)(7)(F)

7E-7

(b)(7)(A), (b)(7)(C), (b)(7)(D), (b)(7)(E)

7E-7

(7)(A), (b)(7)(C), (b)(7)(D), (b)(7)(E)

7E-7

(b)(7)(A), (b)(7)(E)

7E-7

7E-3

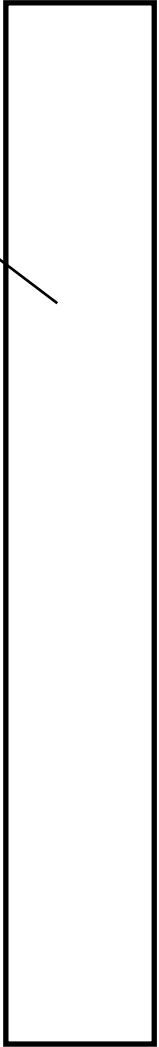
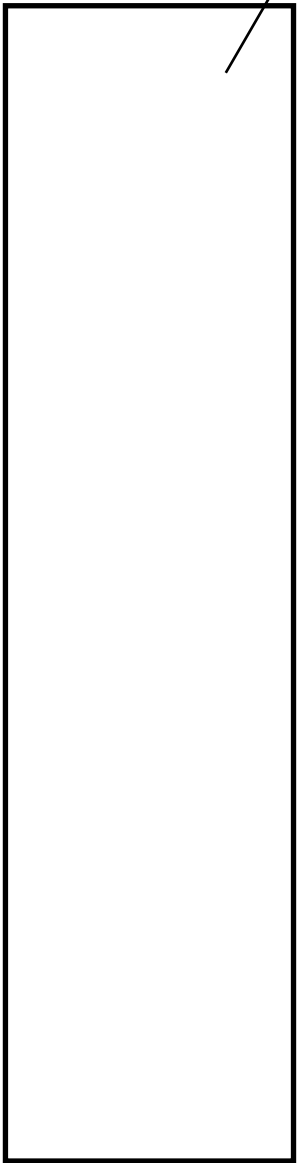

(b)(7)(A), (b)(7)(C), (b)(7)(D), (b)(7)(E)

7E-7

b)(7)(A), (b)(7)(C), (b)(7)(D), (b)(7)(E)

7E-7

(7)(A), (b)(7)(C), (b)(7)(D), (b)(7)(E)

7E-7

b)(7)(A), (b)(7)(C), (b)(7)(D), (b)(7)(E)

7E-7

7E-3

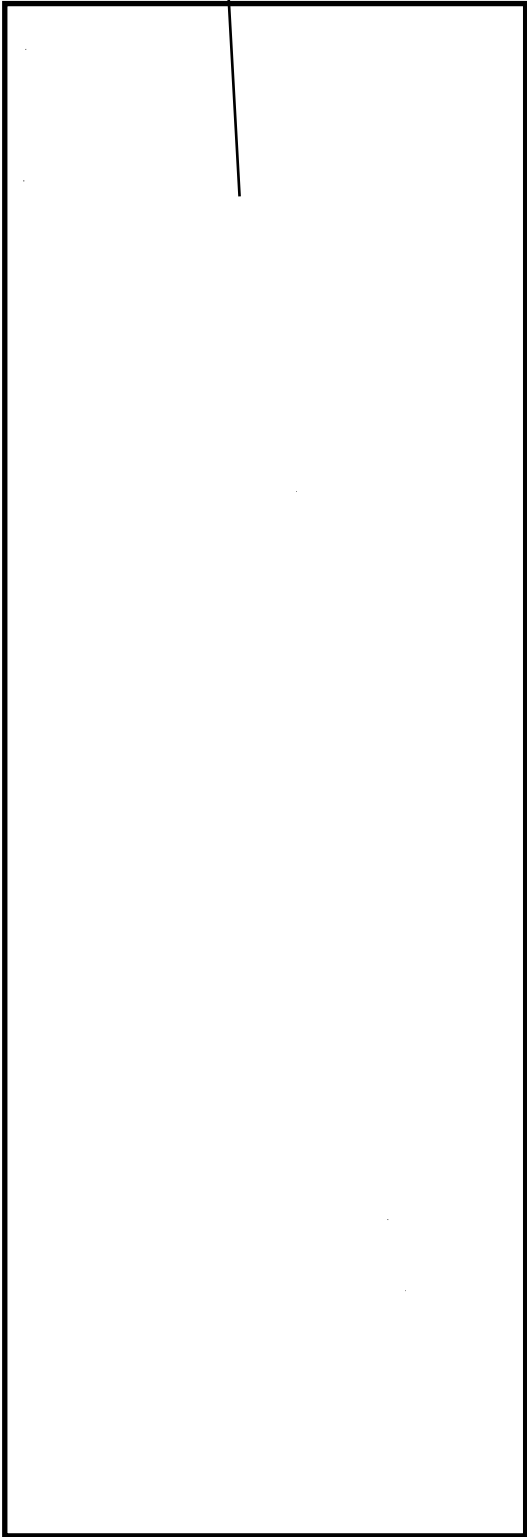

b)(7)(A), (b)(7)(C), (b)(7)(D), (b)(7)(E)

7E-7

7E-3



b)(7)(A), (b)(7)(C), (b)(7)(D), (b)(7)(E)

7E-7

7E-3

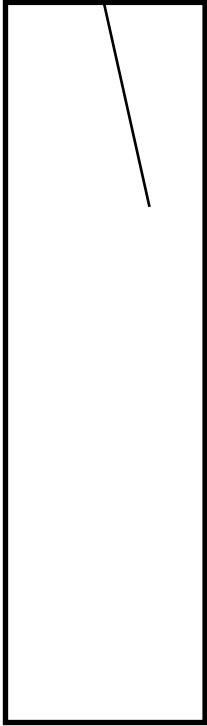

7E-3

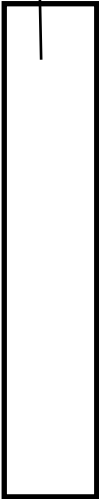

(7)(A), (b)(7)(C), (b)(7)(D), (b)(7)(E)

7E-7

b)(7)(A), (b)(7)(C), (b)(7)(D), (b)(7)(E)

7E-7

7E-3

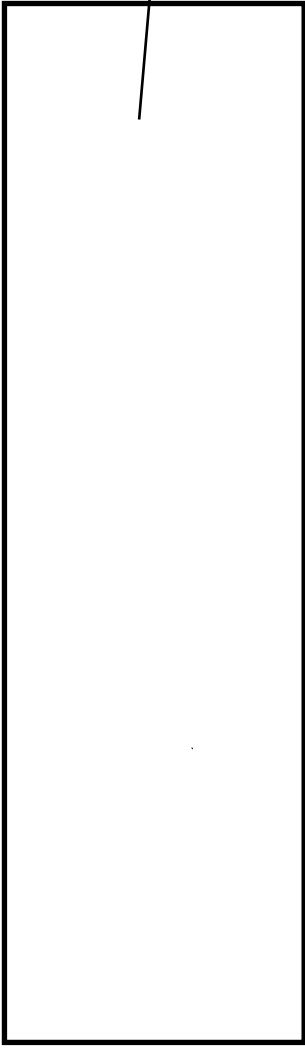

(7)(A), (b)(7)(C), (b)(7)(D), (b)(7)(E)

7E-7

(b)(7)(A), (b)(7)(C), (b)(7)(D), (b)(7)(E)

(b)(7)(A),(b)(7)(C),(b)(7)(D),(b)(7)(E)

7E-7

(b)(7)(A),(b)(7)(C),(b)(7)(D),(b)(7)(E)

7E-7

7E-3

[Redacted]

(b)(7)(A),(b)(7)(C),(b)(7)(D),(b)(7)(E)

7E-7

(b)(7)(A),(b)(7)(C),(b)(7)(D),(b)(7)(E)

7E-7

71

(b)(7)(A), (b)(7)(D), (b)(7)(E)

[Hemisphere Features]

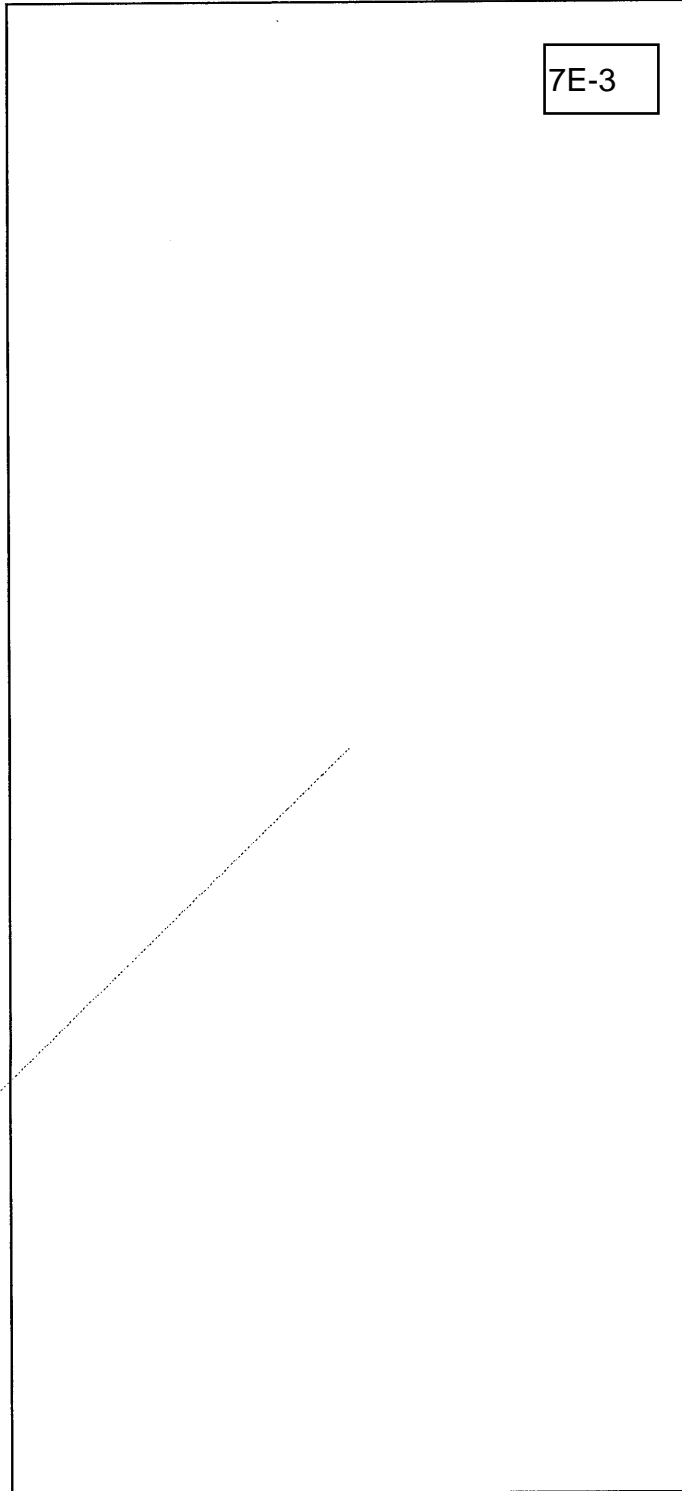

(b)(7)(A),(b)(7)(C),(b)(7)(D),(b)(7)(E)

7E-7

7E-3

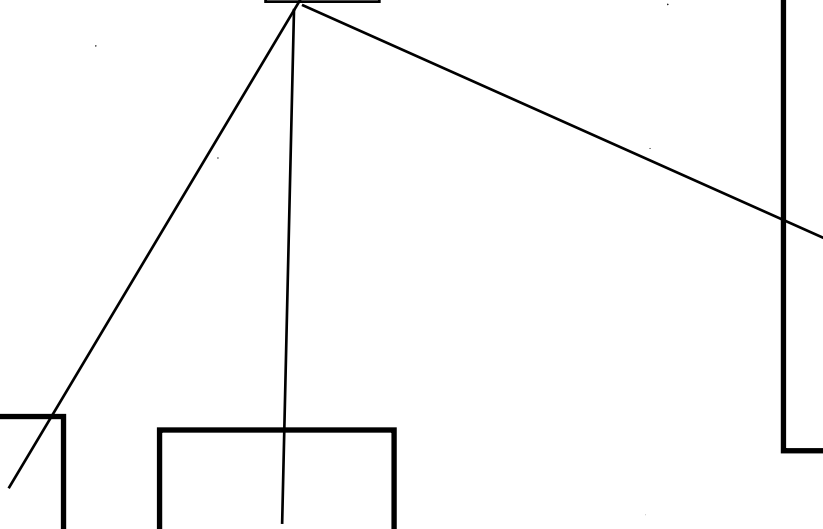
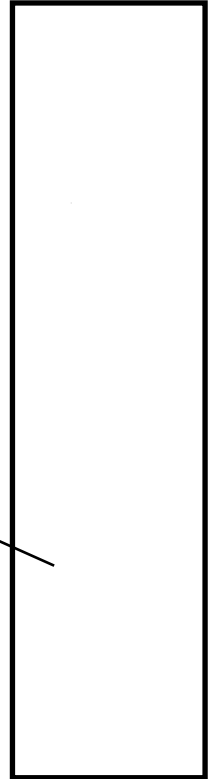
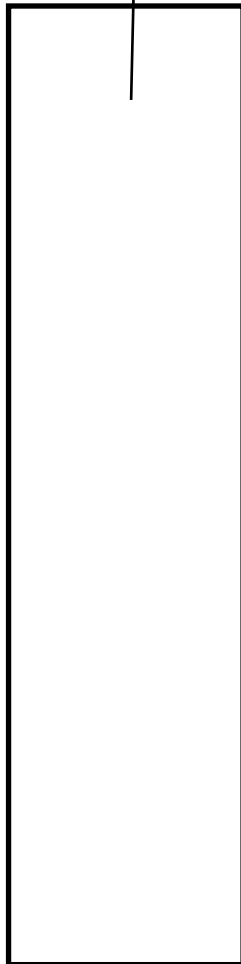
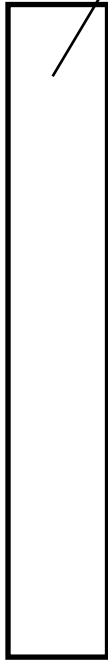

(b)(7)(A),(b)(7)(C),(b)(7)(D),(b)(7)(E)

7E-7

7E-3

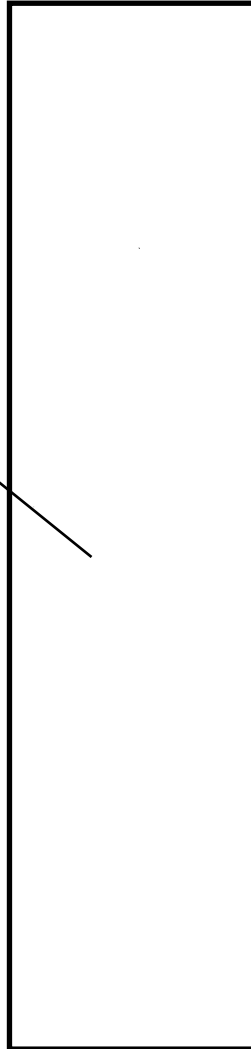
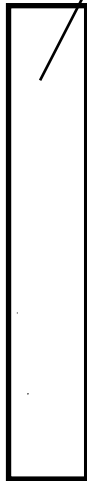

(b)(7)(A),(b)(7)(C),(b)(7)(D),(b)(7)(E)

7E-3

7E-7

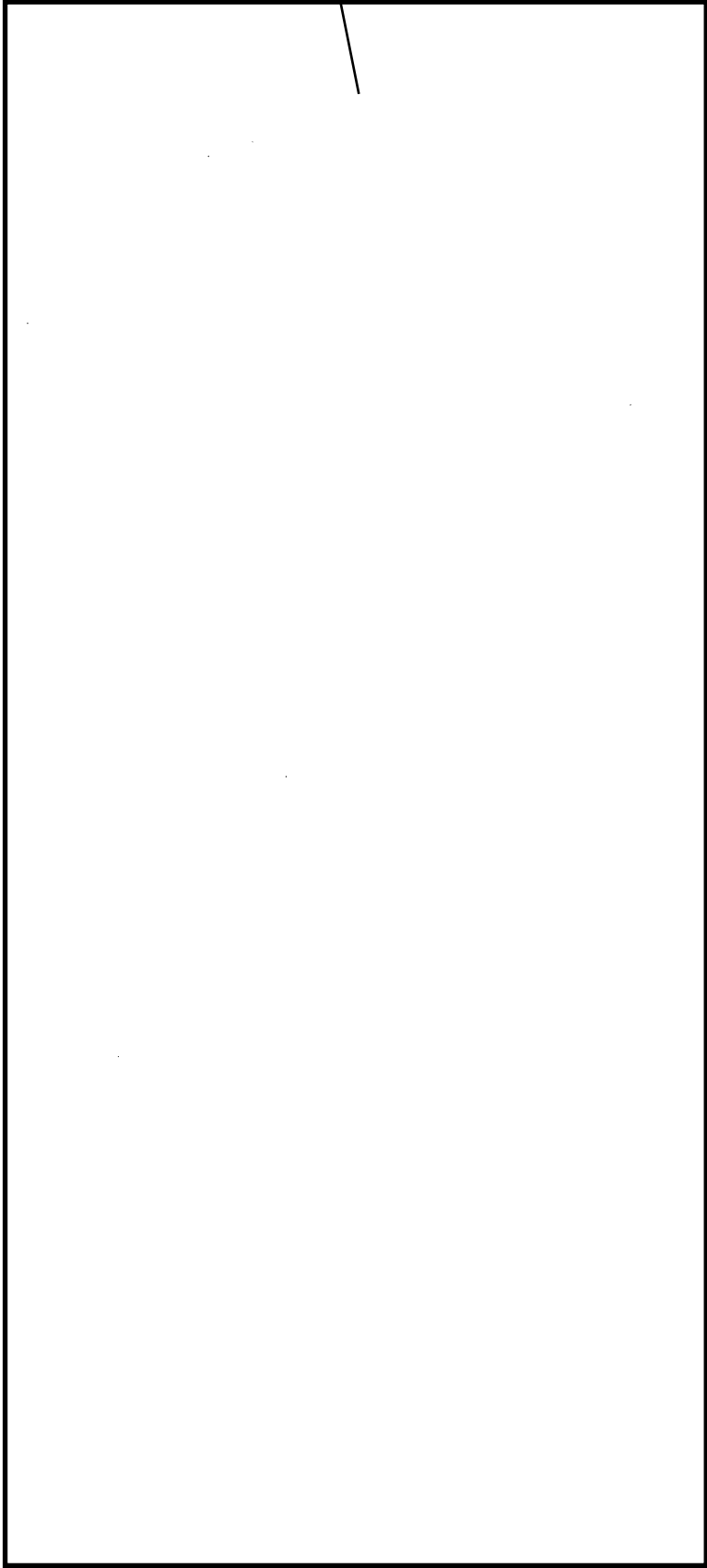

(b)(7)(A),(b)(7)(C),(b)(7)(D),(b)(7)(E)

7E-7

7E-3

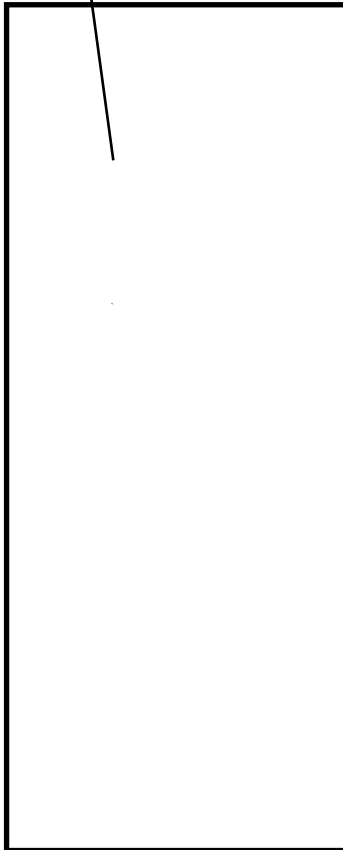

(b)(7)(A), (b)(7)(C), (b)(7)(D), (b)(7)(E)

7E-7

(b)(7)(A), (b)(7)(D), (b)(7)(E)

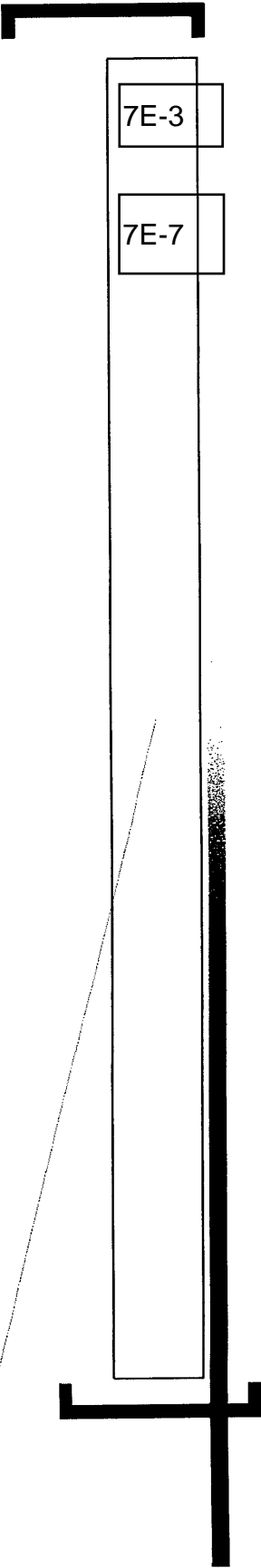

ATLANTA HIDTA
HIGH INTENSITY DRUG TRAFFICKING AREA
Office of National Drug Control Policy

7E-3

7E-7

(b)(7)(A), (b)(7)(D), (b)(7)(E)

(b)(7)(A),(b)(7)(C),(b)(7)(D),(b)(7)(E)

7E-7

]

7E-7

[

(b)(7)(A), (b)(7)(D), (b)(7)(E)



ATLANTA HIDTA
HIGH INTENSITY DRUG TRAFFICKING AREA
Office of National Drug Control Policy

(b)(7)(A),(b)(7)(C),(b)(7)(D),(b)(7)(E)

7E-7

(b)(7)(A), (b)(7)(D), (b)(7)(E)

]

[
7E-7

HEMISPHERE



**ATLANTA HIDTA
HIGH INTENSITY DRUG TRAFFICKING AREA
Office of National Drug Control Policy**

(b)(7)(A),(b)(7)(C),(b)(7)(D),(b)(7)(E)

7E-7

(b)(7)(A), (b)(7)(D), (b)(7)(E)

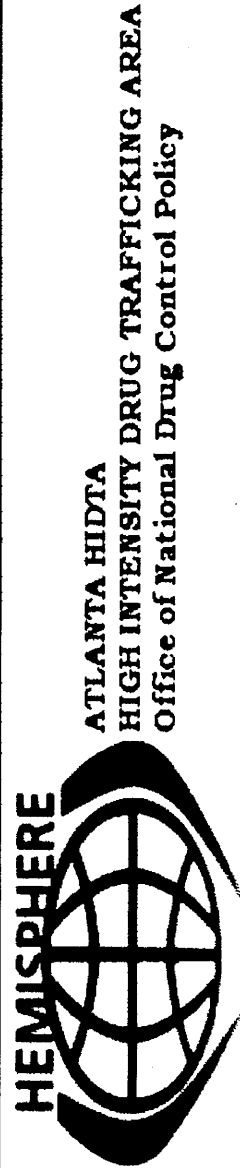
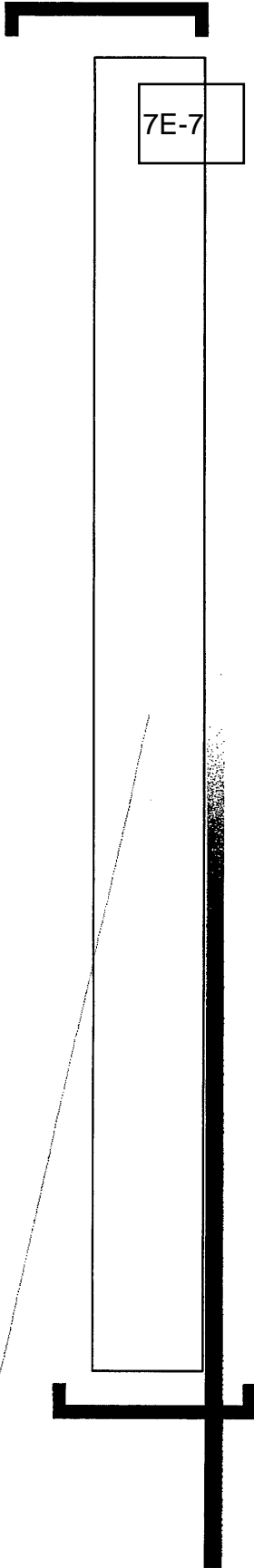

7E-7

(b)(7)(A), (b)(7)(D), (b)(7)(E)

7E-7

(b)(7)(A), (b)(7)(C), (b)(7)(D), (b)(7)(E)

(b)(7)(A),(b)(7)(C),(b)(7)(D),(b)(7)(E)

7E-7

[Hemisphere Reports]

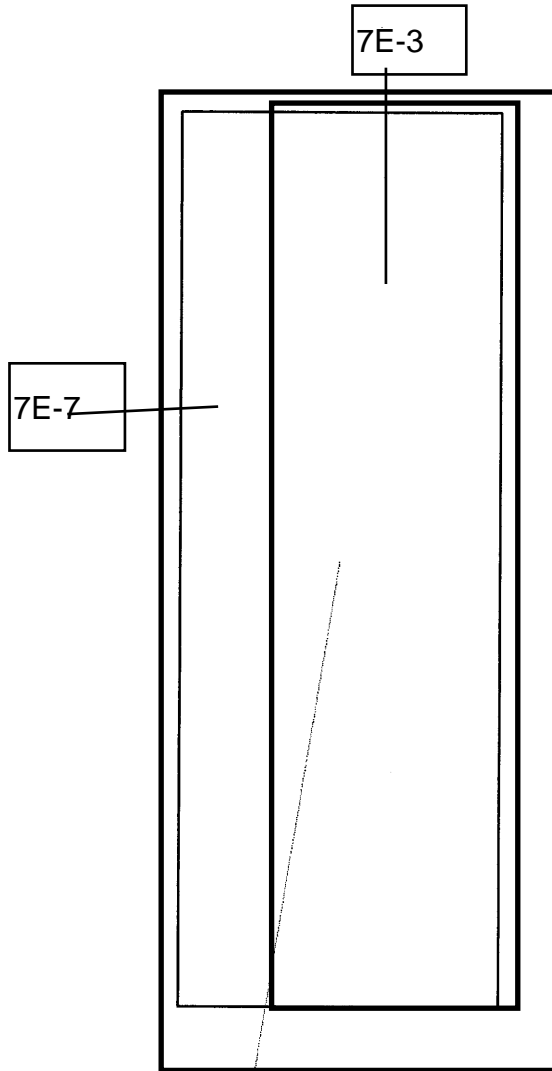

(b)(7)(A), (b)(7)(D), (b)(7)(E)

]

[Redacted]	7E-7	7E-3
------------	------	------

Report

[



HEMISPHERE

**ATLANTA HIDTA
 HIGH INTENSITY DRUG TRAFFICKING AREA
 Office of National Drug Control Policy**

7E-7

7E-3

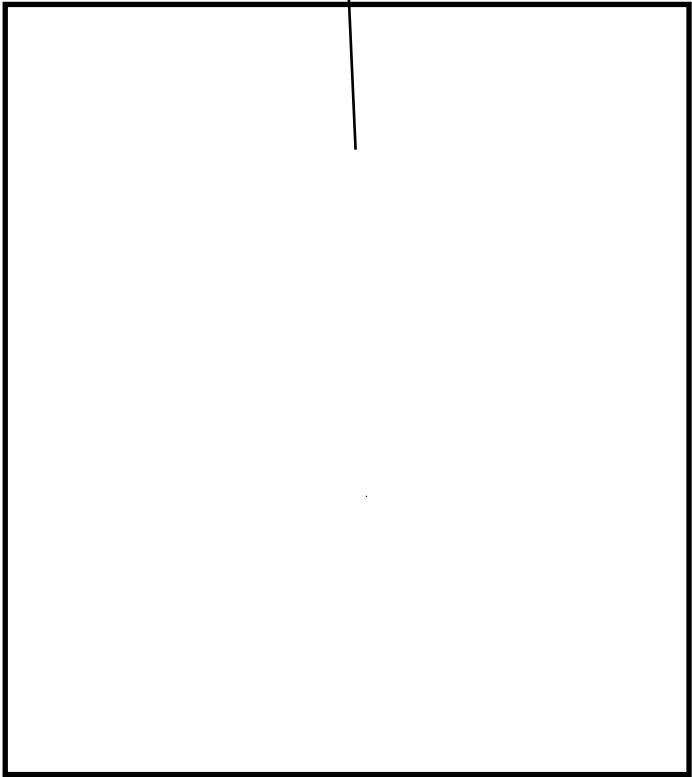

7D-1, 7E-6



6-1, 7C-1, 7E-8, 7F-1



b)(6), (b)(7)(A), (b)(7)(C), (b)(7)(D), (b)(7)(E), (b)(7)(F)

(b)(7)(A),(b)(7)(C),(b)(7)(D),(b)(7)(E)

7E-7

7E-3

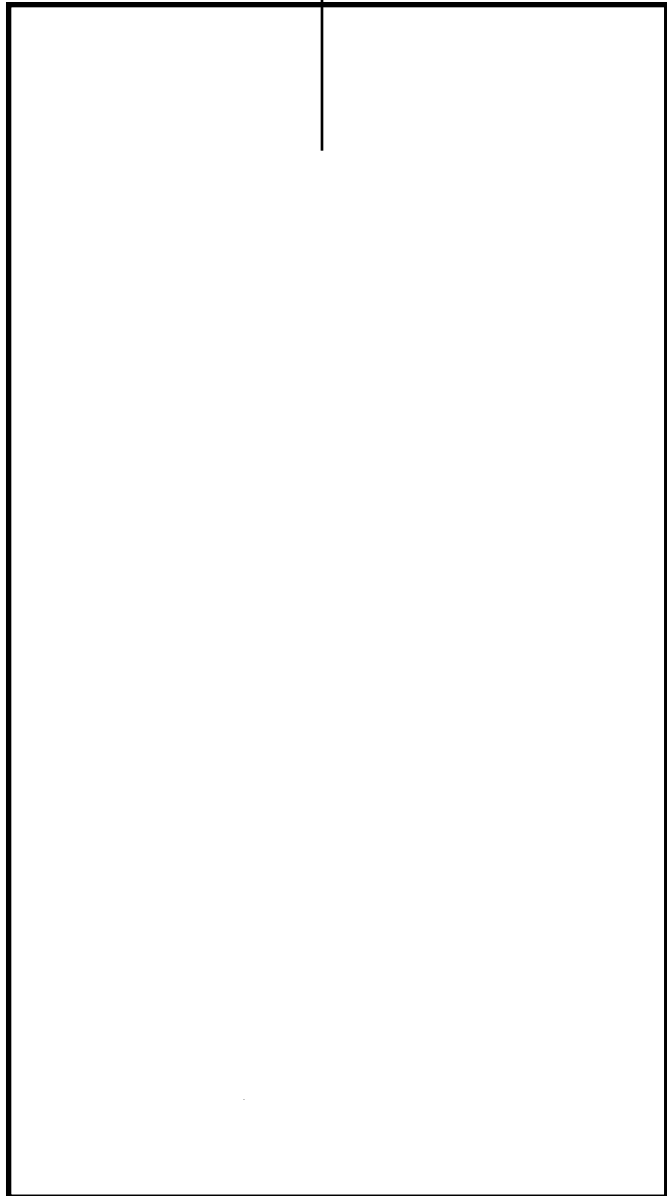

[

(b)(7)(A), (b)(7)(D), (b)(7)(E)

7E-3

7E-7

]



ATLANTA HIDTA
HIGH INTENSITY DRUG TRAFFICKING AREA
Office of National Drug Control Policy

7E-3

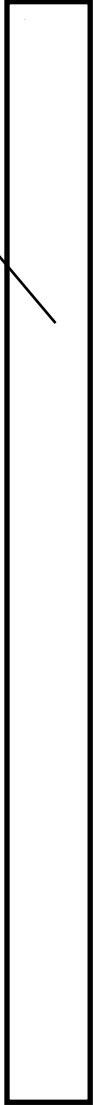
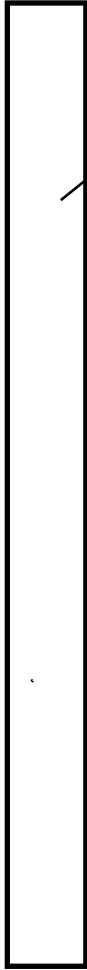

7E-7

6-1, 7C-1, 7E-8, 7F-1

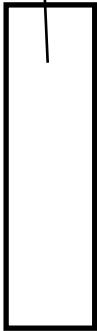

(b)(6), (b)(7)(A), (b)(7)(C), (b)(7)(D), (b)(7)(E), (b)(7)(F)

[HEMISPHERE **]**

**Any
Questions?**

]

[Success Stories]

95

(b)(7)(A),(b)(7)(C),(b)(7)(D),(b)(7)(E)

6-2, 7C-2

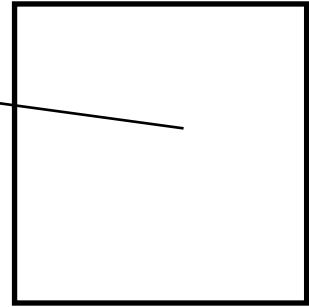

7E-5

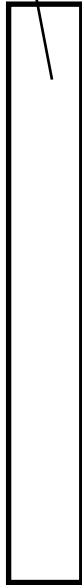

7E-3

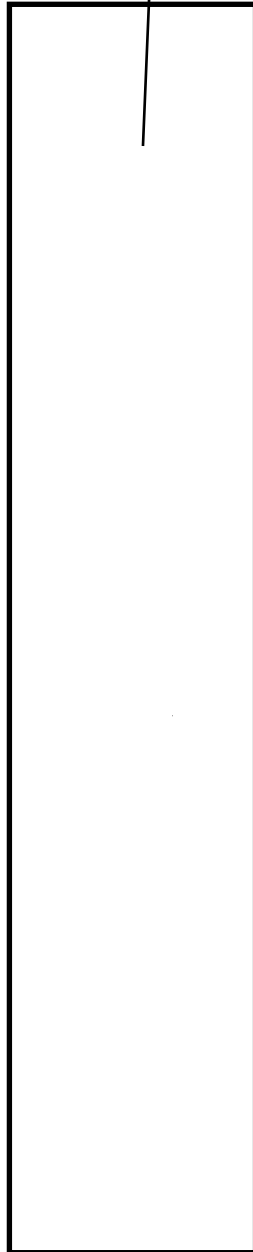

7E-10

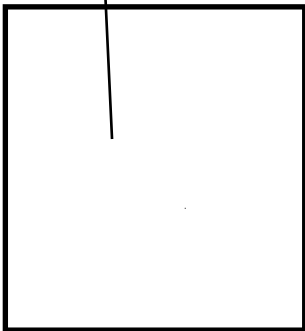

7E-3

(b)(7)(A),(b)(7)(D),(b)(7)(E)

[Redacted]

7E-10

(b)(7)(A), (b)(7)(C), (b)(7)(D), (b)(7)(E)

7E-3

7E-10

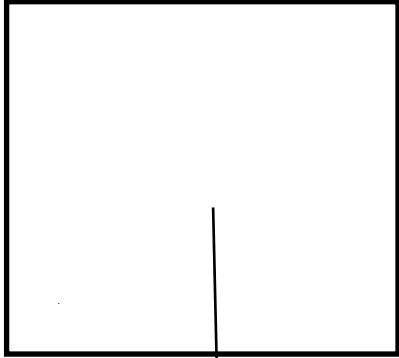

7E-5

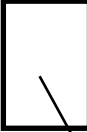
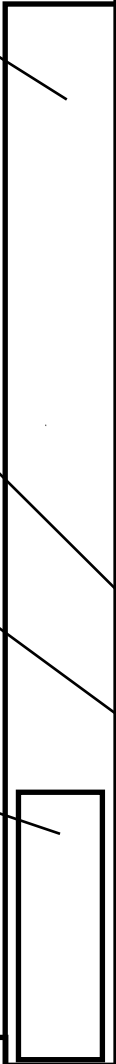
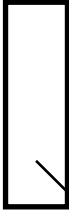

6-1, 7C-1, 7E-8, 7F-1

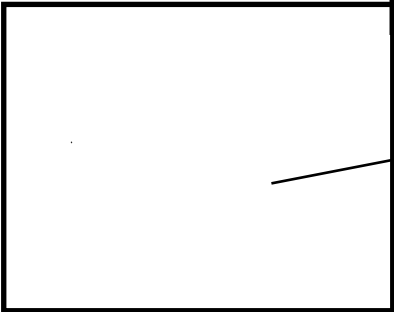

6-2, 7C-2

(b)(7)(A),(b)(7)(C),(b)(7)(D),(b)(7)(E)

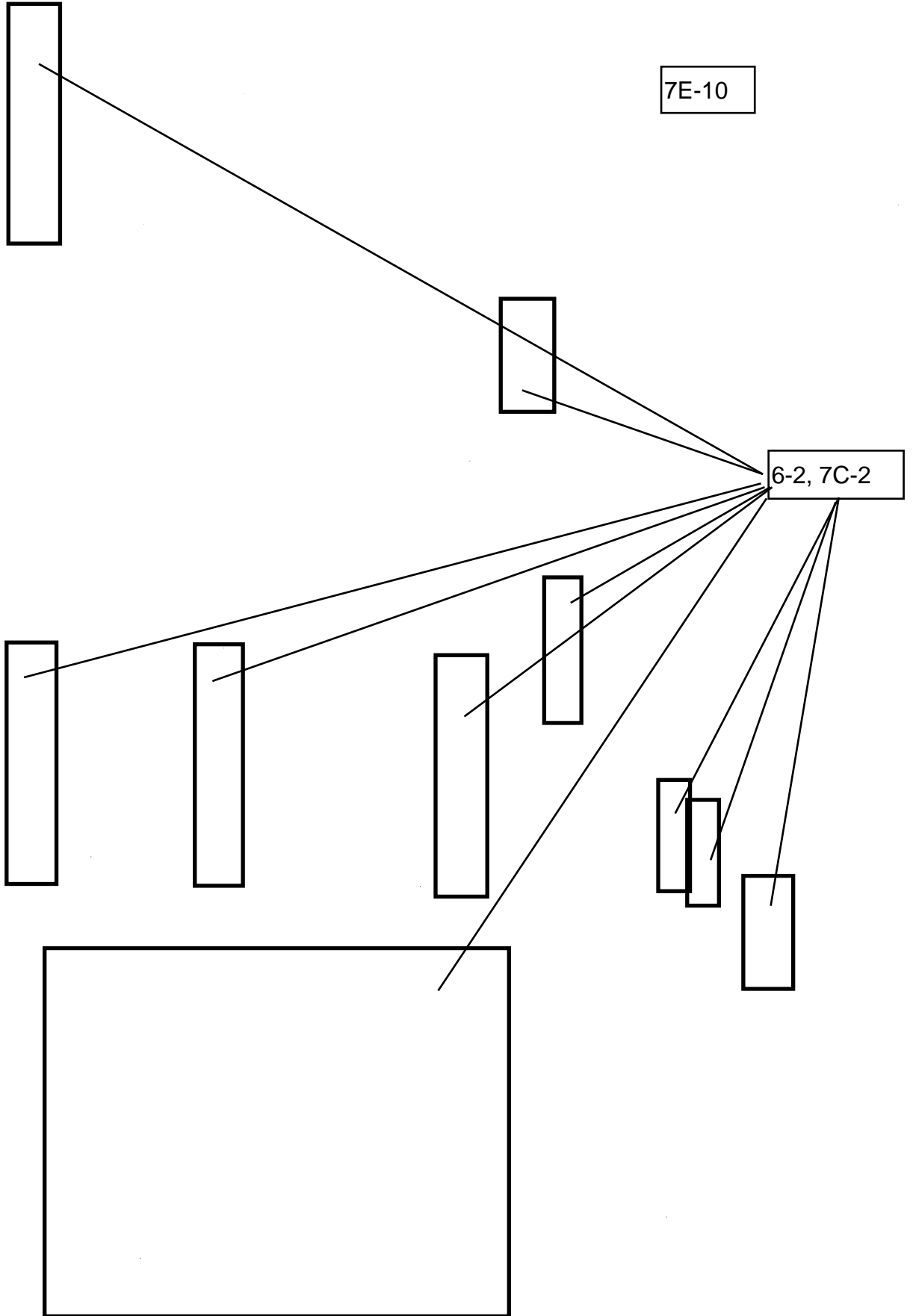

(b)(7)(A),(b)(7)(C),(b)(7)(D),(b)(7)(E)

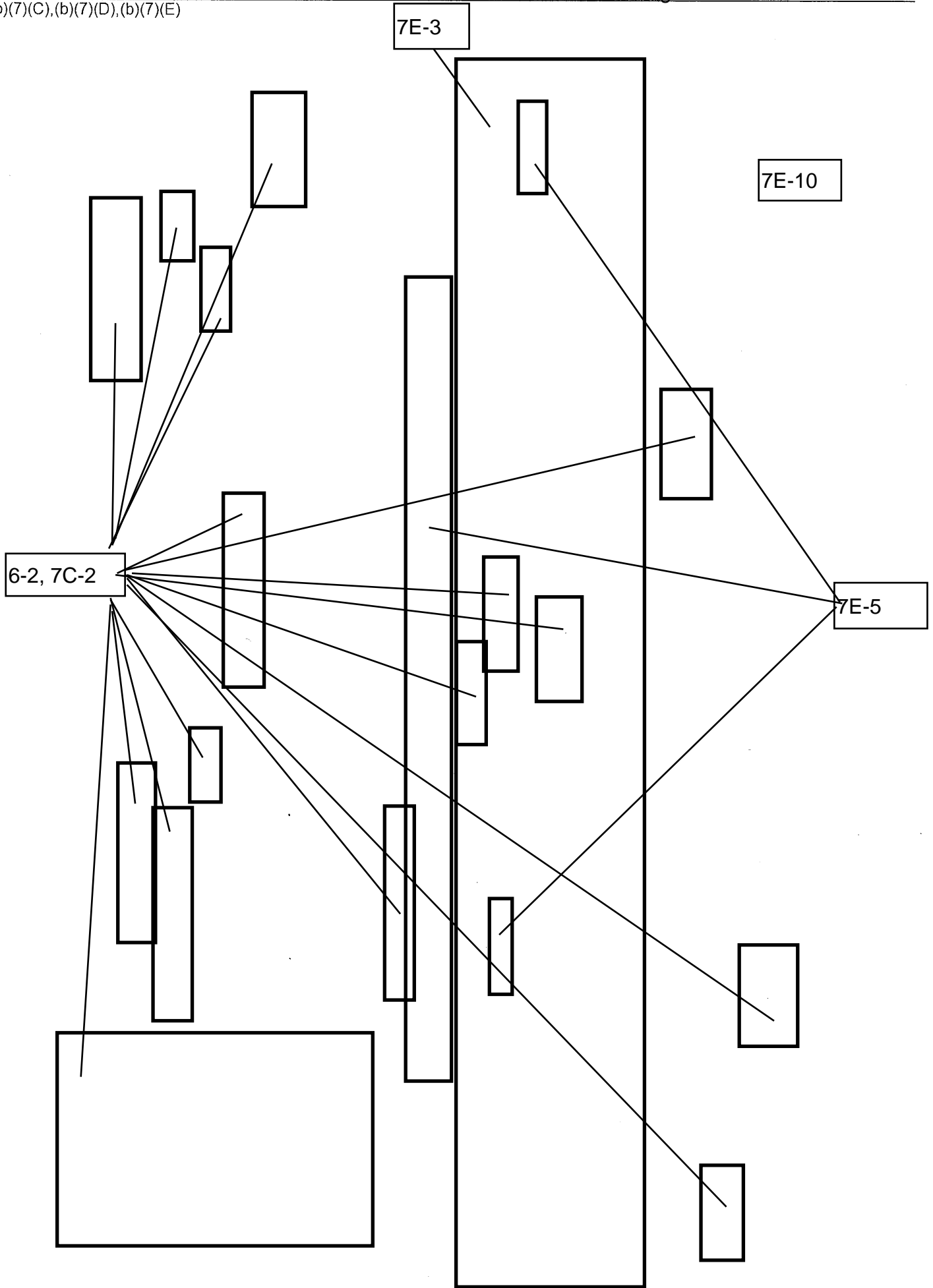

[Hemisphere Summary]

101

(b)(7)(A), (b)(7)(E), (b)(7)(F)

[Hemisphere Summary]

- The Hemisphere Project is a *law enforcement sensitive* program funded by ONDCP

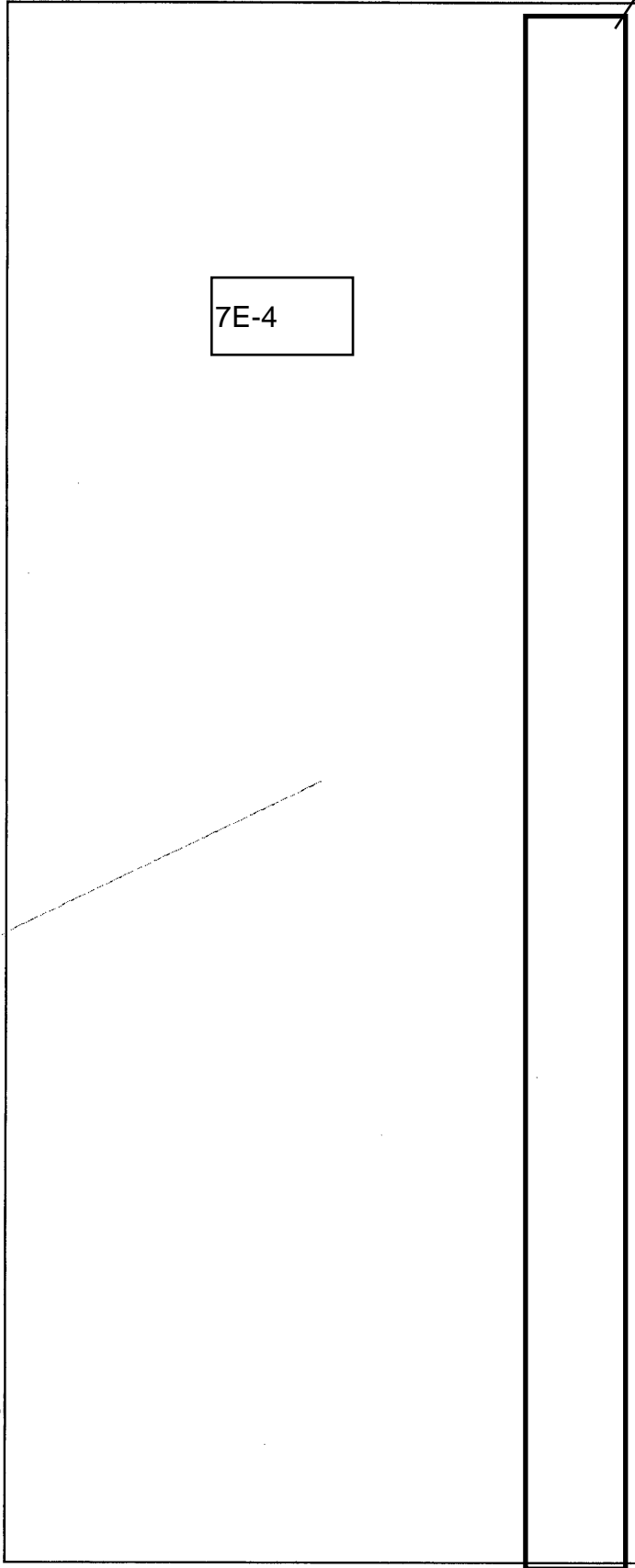

7E-2

102

(b)(7)(A), (b)(7)(D), (b)(7)(E)

[Hemisphere Summary]

7E-4

7E-2

7E-7

7E-3

[Redacted]	[Redacted]	[Redacted]	[Redacted]
------------	------------	------------	------------

103

(b)(7)(A), (b)(7)(D), (b)(7)(E)

[Hemisphere Summary]

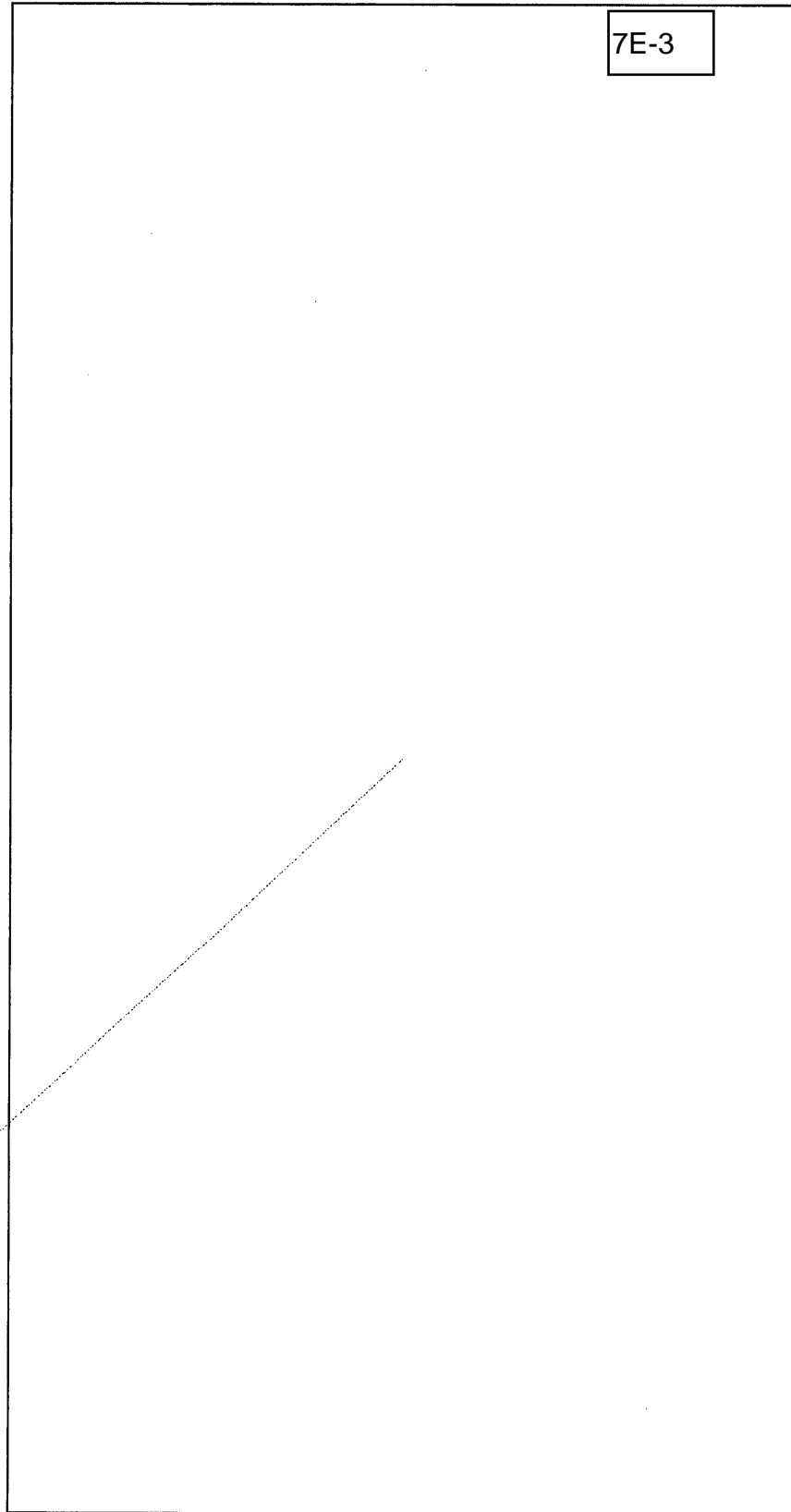

104

(b)(7)(A), (b)(7)(C), (b)(7)(E), (b)(7)(F)

HEMISPHERE Project Info

--	--

7E-4

7E-1

105

[HEMISPHERE **]**

**Any
Questions?**

]

HEMISPHERE Request Form

[

HEMISPHERE

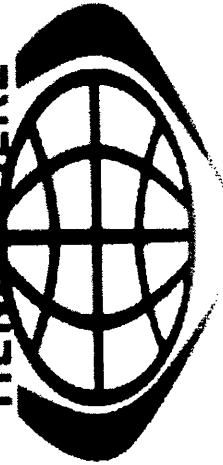

**ATLANTA HIDTA
HIGH INTENSITY DRUG TRAFFICKING AREA
Office of National Drug Control Policy**



Hemisphere Project Request Form ATLANTA HIDTA

HIGH INTENSITY DRUG TRAFFIC KING AREA
Office of National Drug Control Policy

Print Entire Form

Please Fax When Complete

HRC Fax: (b)(7)(A), (b)(7)(E)

7E-1

Master Case Number: [] **Priority:** [] **Current Date:** 2008-11-05 13:07:55

HIDTA Point of Contac Name: [] **Email Results To:** []

POC Phone Number: [] **Email Notification Of Co** []

Name: [] **Number:** []

Case # assigned by the requesting agency (circled callout)

7E-9 (circled callout)

7E-2 (circled callout)

(b)(7)(A), (b)(7)(E) (circled callout)

Case Name (if applicable): []

DTO Name (if applicable): []

HIDTA Initiative: [] **HIDTA Initiative OR Law Enforcement Agency:** []

Yes No

Squad Name: []

Time Zone Results Requested In: []

HEMISPHERE REQUEST FORM- PRIORITY RATING

(b)(7)(A), (b)(7)(D),
(b)(7)(E)

Priority section: This section determines the urgency level of the request

7E-2
7E-9

7E-3

7E-9



Hemisphere Project Request Form ATLANTA HIDTA

HIGH INTENSITY DRUG TRAFFIC KING AREA
Office of National Drug Control Policy

Print Entire Form

Please Fax When Complete

HRC Fax: (b)(7)(A), (b)(7)(E)

7E-1

Master Case Number: Priority: Current Date: 2008-11-05 13:07:55

HIDTA Point of Contac Name: Email Results To:

OC Phone Number: Email Notifcation Of Completion To:

Requestor Name: Email Results To:

Phone Number: Email Notification Of Completion:

Case Name (if applicable):

HIDTA Initiative: Enforcement:

Squad Name:

Time Zone Results Requested In:

Yes No

Name of your HIDTA Point of Contact

Telephone # of your HIDTA Point of Contact

E-mail of your HIDTA Point of Contact



Hemisphere Project Request Form ATLANTA HIDTA

Print Entire Form

Please Fax When Complete

HRC Fax: (b)(7)(A), (b)(7)(E)

7E-1

HIGH INTENSITY DRUG TRAFFIC KING AREA
Office of National Drug Control Policy

Master Case Number: **Priority:** **Current Date:** 2008-11-05 13:07:55

HIDTA Point of Contact Name: **Email Results To:**

POC Phone Number: **Email Notification Of Completion To:**

Requestor Name: **Email Results To:**

Requestor Phone Number: **Email Notification Of Completion To:**

Requesters Name **Requesters E-Mail**

Requesters Telephone #

Time Zone Requested In:

Requesters **No**

Squad

Initiative OR Placement A

Case Name (if applicable):



Hemisphere Project Request Form ATLANTA HIDTA

Print Entire Form

Please Fax When Complete

HEMISPHERE
OFFICE OF NATIONAL DRUG CONTROL POLICE
HIGHTSMITH DRUG TRAFFICKING AREA
Office of National Drug Control Police

HRC Fax: (b)(7)(A), (b)(7)(E)

7E-1

Master Case Number: **Priority:** **Current Date:** 2008-11-05 13:07:55

HIDTA Point of Contact Name: **Email Results To:**

Name of the Drug Trafficking Organization: **Email Notification Of Completion To:**

Operator Name: **Email Results To:**

Operator Phone Number: **Email Notification Of Completion To:**

Case Name (if applicable):

Case Name (if applicable):

DTO Name (if applicable):

HIDTA Initiative: **HIDTA Initiative OR Law Enforcement Agency:**

Yes **No** **Squad Name:**

Time Zone Results Requested In:

Name assigned by the agency to the case.

Name of the Drug Trafficking Organization



HIGH INTENSITY DRUG TRAFFICKING AREA
Office of National Drug Control Policy

Hemisphere Project Request Form ATLANTA HIDTA

Print Entire Form

Please Fax When Complete

HRC Fax: (b)(7)(A), (b)(7)(E)

7E-1

Master Case Number: Priority: Current Date: 2008-11-05 13:07:55

Contact Name: Email Results To:

Email Notification of Completion To:

Email Results To:

Email Notification Number:

Case Name:

Indicate HIDTA / Non HIDTA and What Agency the Request Should Be Credited to

Indicate What Squad Within Your Agency the Request Should Be Credited to and the Time Zone needed.

DTO Name (if applicable):

HIDTA Initiative: HIDTA Initiative OR Law Enforcement Agency:

Yes No Squad Name:

Time Zone Results Requested In:

7E-2

7E-3

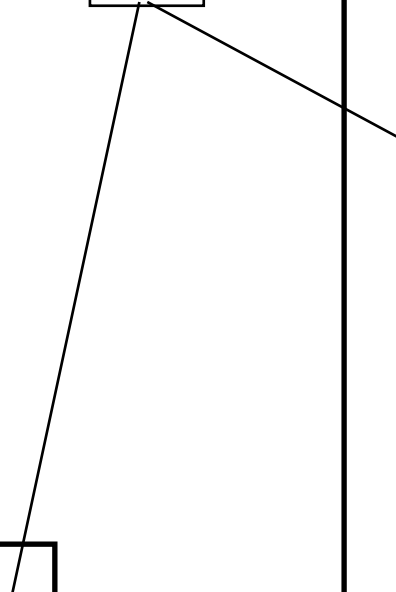

(b)(7)(A), (b)(7)(C), (b)(7)(D), (b)(7)(E)

(b)(7)(A), (b)(7)(D), (b)(7)(E)

HEMISPHERE REQUEST FORM-

]

[

Hemisphere

include:

7E-3

7E-2

7E-4

7E-5

7E-7

7E-3

7E-2

7E-4

Hemisphere

(b)(7)(A), (b)(7)(D), (b)(7)(E)

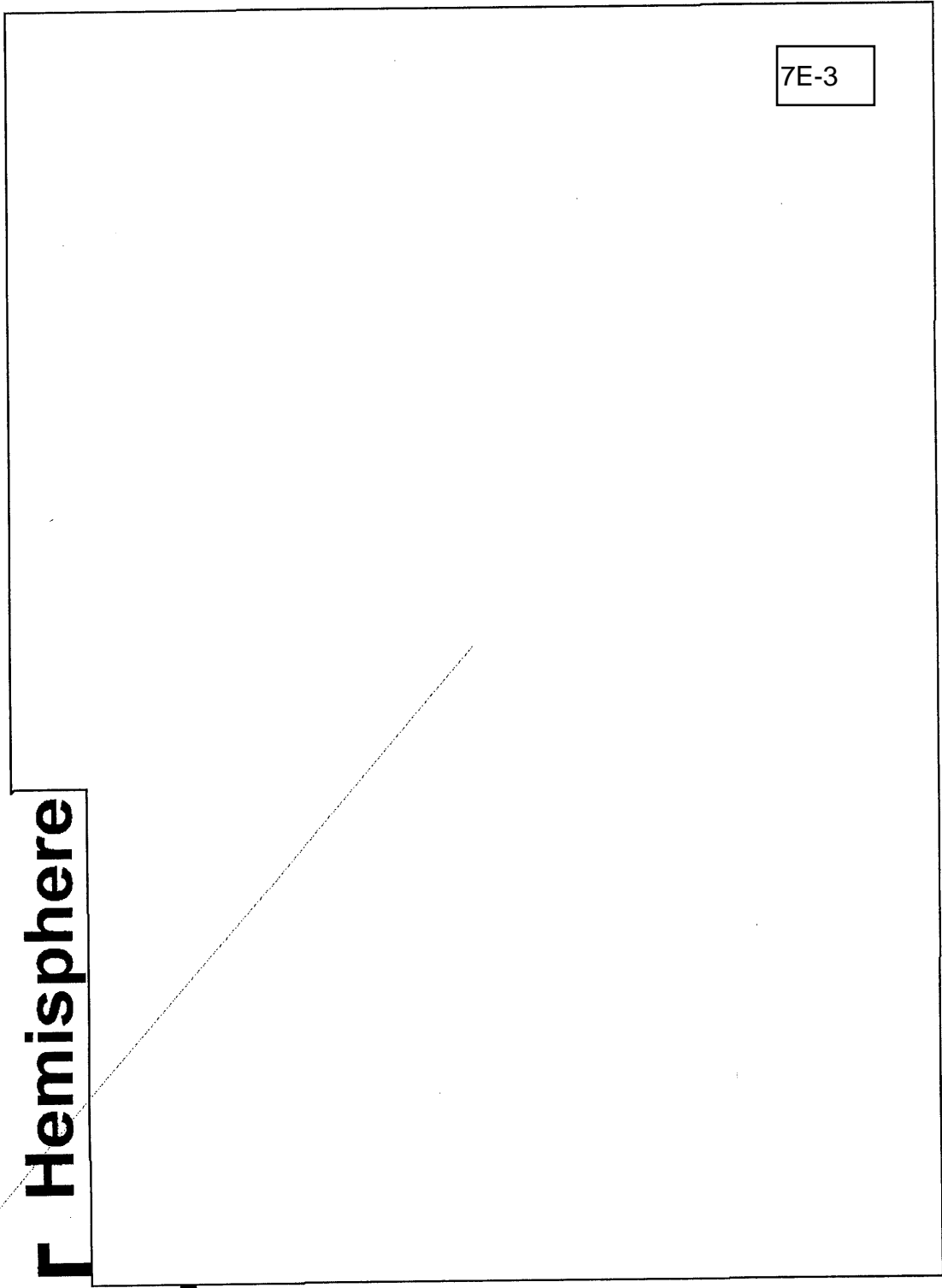

7E-3

(b)(7)(A), (b)(7)(D), (b)(7)(E)

Hemisphere



7E-2

7E-3

Hemisphere

(b)(7)(A), (b)(7)(D), (b)(7)(E)

(b)(7)(A), (b)(7)(C), (b)(7)(E)

Phone Number

Priority

Date Range

			7E-2
			7E-9

]

[Sample Requests

(b)(7)(A), (b)(7)(C), (b)(7)(D), (b)(7)(E)

Yes No

Squad Name:

Time Zone Results Requested In:

Eastern Standard Time (EST -5)

7E-2

7E-5

[Redacted]

7E-5

(b)(7)(A), (b)(7)(C), (b)(7)(D), (b)(7)(E)

UNITED STATES DEPARTMENT OF JUSTICE

Yes No

Squad Name:

Time Zone Results Requested In:

Eastern Standard Time (EST -5)

7E-2

7E-3

7E-5

[Redacted]

(b)(7)(A), (b)(7)(C), (b)(7)(D), (b)(7)(E)

Yes No

Squad Name:

DEA

Time Zone Results Requested In:

Eastern Standard Time (EST -5)

7E-2

7E-3

]

[Subpoenas]

HEMISPHERE

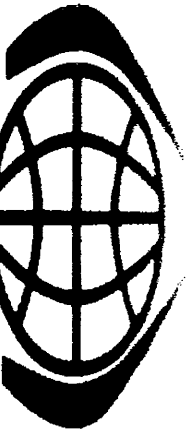

**ATLANTA HIDTA
HIGH INTENSITY DRUG TRAFFICKING AREA
Office of National Drug Control Policy**

(b)(6), (b)(7)(A), (b)(7)(C), (b)(7)(D), (b)(7)(E), (b)(7)(F)

HEMISPHERE Subpoena Language

7E-2

(b)(7)(A), (b)(7)(D), (b)(7)(E), (b)(7)(F)

[HEMISPHERE Subpoena Recipient]

**All Hemisphere subpoenas should have the following
in the recipient/address section...**

7E-2

7D-1, 7E-6

(b)(7)(A), (b)(7)(E)

HEMISPHERE Subpoena

Language

]

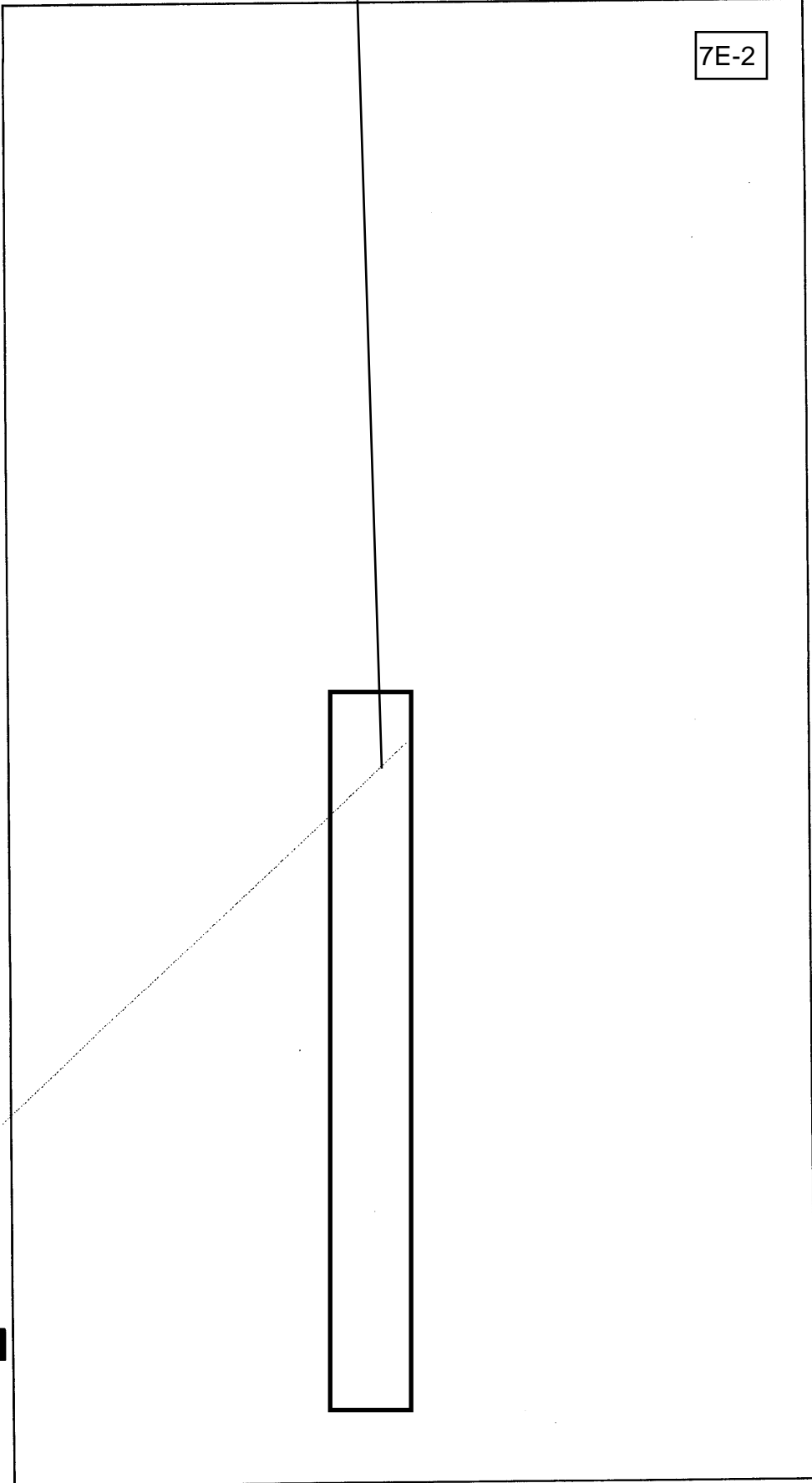

7D-1, 7E-6

7E-2

(b)(6), (b)(7)(A), (b)(7)(C), (b)(7)(D), (b)(7)(E), (b)(7)(F)

HEMISPHERE Subpoena Date Range

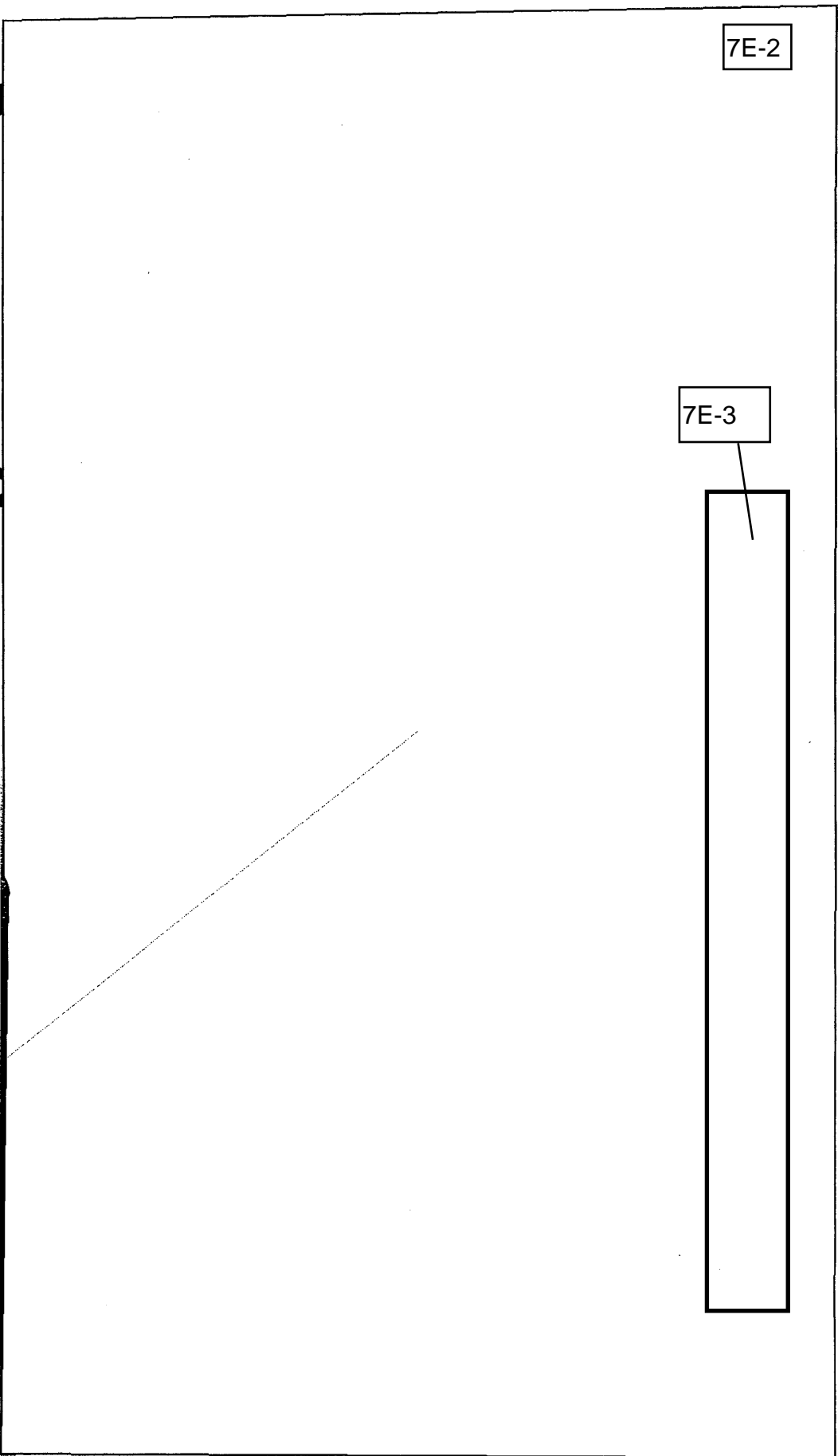

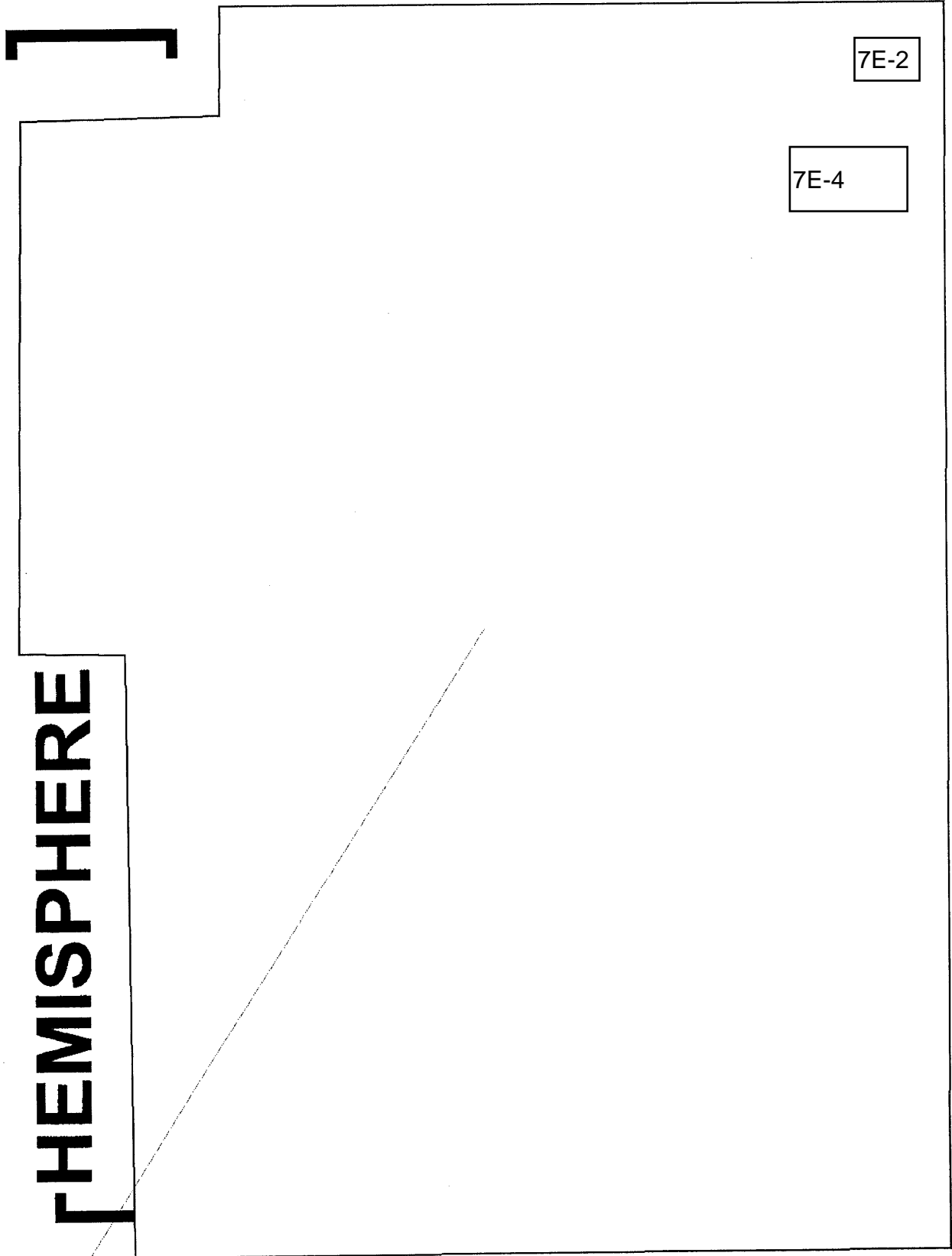

HEMISPHERE

7E-2

7E-4

(b)(7)(A), (b)(7)(D), (b)(7)(E)

(b)(7)(A), (b)(7)(E)

**HEMISPHERE
Subpoena Language**

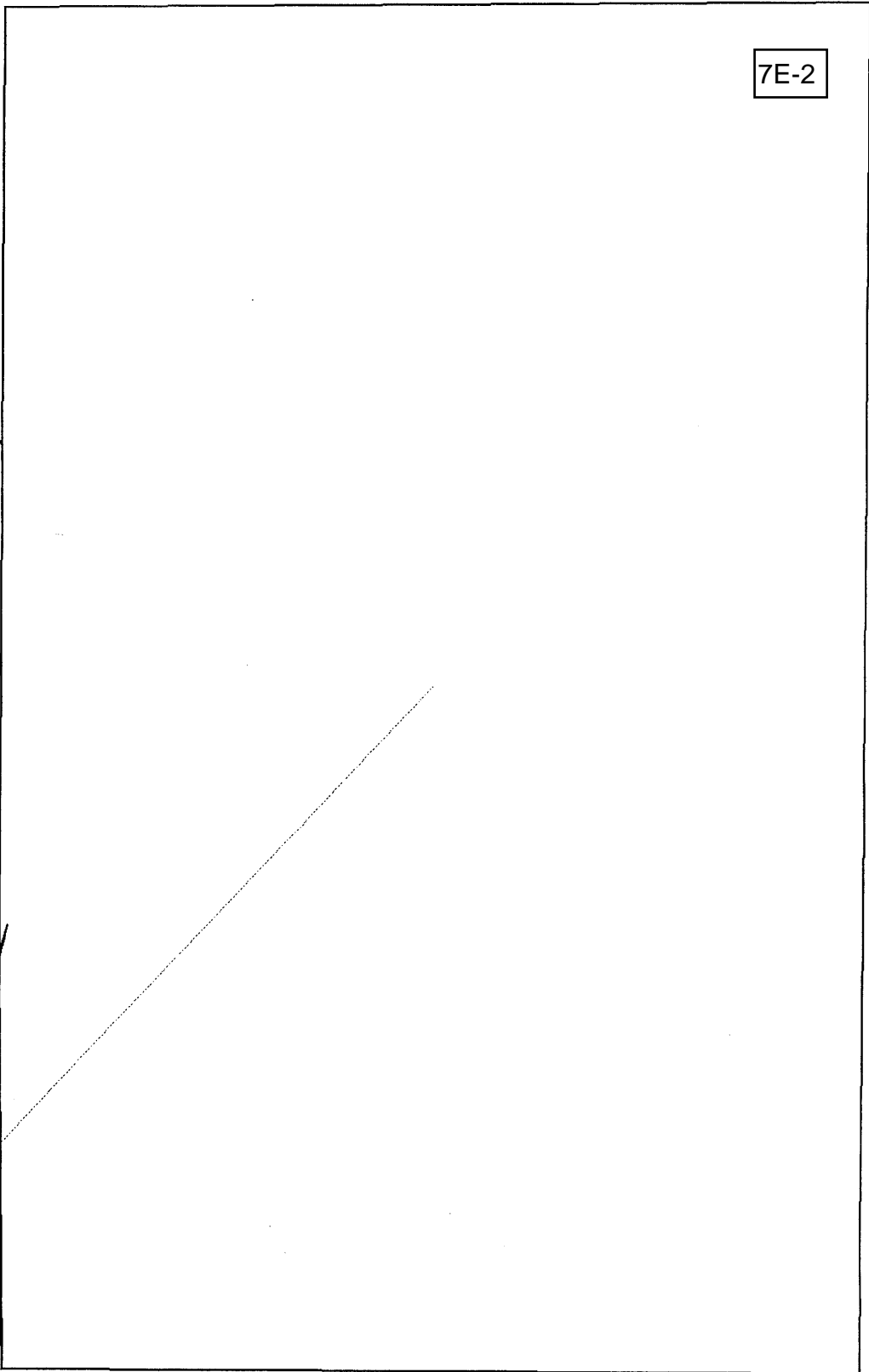

7E-2



Hemisphere Project Request Form APPALACHIA HIDTA

Please Fax When Complete

7E-1

HRC Fax : (b)(7)(A),(b)(7)(E)

HIGH INTENSITY DRUG TRAFFICKING AREA
Office of National Drug Control Policy

Master Case Number:	<input type="text"/>	Priority:	<input type="text"/>	Current Date:	2014-05-29 10:53:55
HIDTA Point of Contac Name:		Email Results To:			
<input type="text"/>		<input type="text"/>			
POC Phone Number:		Email Notification Of Completion To:			
<input type="text"/>		<input type="text"/>			
Requestor Name:		Email Results To:			
<input type="text"/>		<input type="text"/>			
Requestor Phone Number:		Email Notification Of Completion To:			
<input type="text"/>		<input type="text"/>			
DTO Name (if applicable):			Case Name (if applicable):		
<input type="text"/>			<input type="text"/>		
HIDTA Initiative:	HIDTA Initiative OR Law Enforcement Agency:				
Yes <input type="checkbox"/> No <input type="checkbox"/>	<input type="text"/>				
Squad Name:		<input type="text"/>			
Time Zone Results Requested In:		<input type="text"/>			

(b)(7)(A),(b)(7)(E)

7E-2

Phone Number	Priority	Date Range	
<input type="text"/>	<input type="text"/>	<input type="text"/>	<input type="text"/>
<input type="text"/>	<input type="text"/>	<input type="text"/>	<input type="text"/>
<input type="text"/>	<input type="text"/>	<input type="text"/>	<input type="text"/>
<input type="text"/>	<input type="text"/>	<input type="text"/>	<input type="text"/>
<input type="text"/>	<input type="text"/>	<input type="text"/>	<input type="text"/>
<input type="text"/>	<input type="text"/>	<input type="text"/>	<input type="text"/>
<input type="text"/>	<input type="text"/>	<input type="text"/>	<input type="text"/>
<input type="text"/>	<input type="text"/>	<input type="text"/>	<input type="text"/>
<input type="text"/>	<input type="text"/>	<input type="text"/>	<input type="text"/>
<input type="text"/>	<input type="text"/>	<input type="text"/>	<input type="text"/>
<input type="text"/>	<input type="text"/>	<input type="text"/>	<input type="text"/>
<input type="text"/>	<input type="text"/>	<input type="text"/>	<input type="text"/>
<input type="text"/>	<input type="text"/>	<input type="text"/>	<input type="text"/>
<input type="text"/>	<input type="text"/>	<input type="text"/>	<input type="text"/>
<input type="text"/>	<input type="text"/>	<input type="text"/>	<input type="text"/>
<input type="text"/>	<input type="text"/>	<input type="text"/>	<input type="text"/>
<input type="text"/>	<input type="text"/>	<input type="text"/>	<input type="text"/>
<input type="text"/>	<input type="text"/>	<input type="text"/>	<input type="text"/>
<input type="text"/>	<input type="text"/>	<input type="text"/>	<input type="text"/>
<input type="text"/>	<input type="text"/>	<input type="text"/>	<input type="text"/>
<input type="text"/>	<input type="text"/>	<input type="text"/>	<input type="text"/>
<input type="text"/>	<input type="text"/>	<input type="text"/>	<input type="text"/>
<input type="text"/>	<input type="text"/>	<input type="text"/>	<input type="text"/>
<input type="text"/>	<input type="text"/>	<input type="text"/>	<input type="text"/>



Hemisphere Project Request Form ATLANTA HIDTA

Please Fax When Complete

7E-1

HRC Fax : (b)(7)(A), (b)(7)(E)

HIGH INTENSITY DRUG TRAFFICKING AREA
Office of National Drug Control Policy

Master Case Number:	<input type="text"/>	Priority:	<input type="text"/>	Current Date:	2014-05-29 10:54:10
HIDTA Point of Contac Name:		Email Results To:			
<input type="text"/>		<input type="text"/>			
POC Phone Number:		Email Notification Of Completion To:			
<input type="text"/>		<input type="text"/>			
Requestor Name:		Email Results To:			
<input type="text"/>		<input type="text"/>			
Requestor Phone Number:		Email Notification Of Completion To:			
<input type="text"/>		<input type="text"/>			
DTO Name (if applicable):			Case Name (if applicable):		
<input type="text"/>			<input type="text"/>		
HIDTA Initiative:	HIDTA Initiative OR Law Enforcement Agency:				
Yes <input type="checkbox"/> No <input type="checkbox"/>	<input type="text"/>				
Squad Name:		<input type="text"/>			
Time Zone Results Requested In:		<input type="text"/>			

(b)(7)(A), (b)(7)(E)

7E-2

Phone Number	Priority	Date Range	



Hemisphere Project Request Form CENTRAL FLORIDA HIDTA

Please Fax When Complete

7E-1

HRC Fax : (b)(7)(A), (b)(7)(E)

HIGH INTENSITY DRUG TRAFFICKING AREA
Office of National Drug Control Policy

Master Case Number:	<input type="text"/>	Priority:	<input type="text"/>	Current Date:	2014-05-29 10:54:25
HIDTA Point of Contac Name:		Email Results To:			
<input type="text"/>		<input type="text"/>			
POC Phone Number:		Email Notification Of Completion To:			
<input type="text"/>		<input type="text"/>			
Requestor Name:		Email Results To:			
<input type="text"/>		<input type="text"/>			
Requestor Phone Number:		Email Notification Of Completion To:			
<input type="text"/>		<input type="text"/>			
DTO Name (if applicable):			Case Name (if applicable):		
<input type="text"/>			<input type="text"/>		
HIDTA Initiative:	HIDTA Initiative OR Law Enforcement Agency:	<input type="text"/>			
Yes <input type="checkbox"/> No <input type="checkbox"/>	Squad Name:	<input type="text"/>			
Time Zone Results Requested In:		<input type="text"/>			

(b)(7)(A), (b)(7)(E)

7E-2

Phone Number

Priority

Date Range

Phone Number	Priority	Date Range	



Hemisphere Project Request Form LAKE COUNTY HIDTA

Please Fax When Complete

7E-1

HRC Fax : (b)(7)(A), (b)(7)(E)

HIGH INTENSITY DRUG TRAFFICKING AREA
Office of National Drug Control Policy

Master Case Number:	<input type="text"/>	Priority:	<input type="text"/>	Current Date:	<input type="text" value="2014-05-29 10:54:37"/>
HIDTA Point of Contact Name:		Email Results To:			
<input type="text"/>		<input type="text"/>			
POC Phone Number:		Email Notification Of Completion To:			
<input type="text"/>		<input type="text"/>			
Requestor Name:		Email Results To:			
<input type="text"/>		<input type="text"/>			
Requestor Phone Number:		Email Notification Of Completion To:			
<input type="text"/>		<input type="text"/>			
DTO Name (if applicable):			Case Name (if applicable):		
<input type="text"/>			<input type="text"/>		
HIDTA Initiative:	HIDTA Initiative OR Law Enforcement Agency:				
Yes <input type="checkbox"/> No <input type="checkbox"/>	<input type="text"/>				
Squad Name:		<input type="text"/>			
Time Zone Results Requested In:		<input type="text"/>			

(b)(7)(A), (b)(7)(E)

7E-2

Phone Number	Priority	Date Range	



Hemisphere Project Request Form MICHIGAN HIDTA

Please Fax When Complete

7E-1

HRC Fax : (b)(7)(A),(b)(7)(E)

HIGH INTENSITY DRUG TRAFFICKING AREA
Office of National Drug Control Policy

Master Case Number:	<input type="text"/>	Priority:	<input type="text"/>	Current Date:	<input type="text" value="2014-05-29 10:54:50"/>
HIDTA Point of Contact Name:		Email Results To:			
<input type="text"/>		<input type="text"/>			
POC Phone Number:		Email Notification Of Completion To:			
<input type="text"/>		<input type="text"/>			
Requestor Name:		Email Results To:			
<input type="text"/>		<input type="text"/>			
Requestor Phone Number:		Email Notification Of Completion To:			
<input type="text"/>		<input type="text"/>			
DTO Name (if applicable):			Case Name (if applicable):		
<input type="text"/>			<input type="text"/>		
HIDTA Initiative:	HIDTA Initiative OR Law Enforcement Agency:				
Yes <input type="checkbox"/> No <input type="checkbox"/>	<input type="text"/>				
Squad Name:		<input type="text"/>			
Time Zone Results Requested In:		<input type="text"/>			

(b)(7)(A) (b)(7)(E)

7E-2

Phone Number	Priority	Date Range	
<input type="text"/>	<input type="text"/>	<input type="text"/>	<input type="text"/>
<input type="text"/>	<input type="text"/>	<input type="text"/>	<input type="text"/>
<input type="text"/>	<input type="text"/>	<input type="text"/>	<input type="text"/>
<input type="text"/>	<input type="text"/>	<input type="text"/>	<input type="text"/>
<input type="text"/>	<input type="text"/>	<input type="text"/>	<input type="text"/>
<input type="text"/>	<input type="text"/>	<input type="text"/>	<input type="text"/>
<input type="text"/>	<input type="text"/>	<input type="text"/>	<input type="text"/>
<input type="text"/>	<input type="text"/>	<input type="text"/>	<input type="text"/>
<input type="text"/>	<input type="text"/>	<input type="text"/>	<input type="text"/>
<input type="text"/>	<input type="text"/>	<input type="text"/>	<input type="text"/>
<input type="text"/>	<input type="text"/>	<input type="text"/>	<input type="text"/>
<input type="text"/>	<input type="text"/>	<input type="text"/>	<input type="text"/>
<input type="text"/>	<input type="text"/>	<input type="text"/>	<input type="text"/>
<input type="text"/>	<input type="text"/>	<input type="text"/>	<input type="text"/>
<input type="text"/>	<input type="text"/>	<input type="text"/>	<input type="text"/>
<input type="text"/>	<input type="text"/>	<input type="text"/>	<input type="text"/>
<input type="text"/>	<input type="text"/>	<input type="text"/>	<input type="text"/>
<input type="text"/>	<input type="text"/>	<input type="text"/>	<input type="text"/>
<input type="text"/>	<input type="text"/>	<input type="text"/>	<input type="text"/>
<input type="text"/>	<input type="text"/>	<input type="text"/>	<input type="text"/>
<input type="text"/>	<input type="text"/>	<input type="text"/>	<input type="text"/>
<input type="text"/>	<input type="text"/>	<input type="text"/>	<input type="text"/>
<input type="text"/>	<input type="text"/>	<input type="text"/>	<input type="text"/>
<input type="text"/>	<input type="text"/>	<input type="text"/>	<input type="text"/>



Hemisphere Project Request Form NEW ENGLAND HIDTA

Please Fax When Complete

7E-1

HRC Fax : (b)(7)(A), (b)(7)(E)

HIGH INTENSITY DRUG TRAFFICKING AREA
Office of National Drug Control Policy

Master Case Number:	<input type="text"/>	Priority:	<input type="text"/>	Current Date:	2014-05-29 10:55:03
HIDTA Point of Contact Name:		Email Results To:			
<input type="text"/>		<input type="text"/>			
POC Phone Number:		Email Notification Of Completion To:			
<input type="text"/>		<input type="text"/>			
Requestor Name:		Email Results To:			
<input type="text"/>		<input type="text"/>			
Requestor Phone Number:		Email Notification Of Completion To:			
<input type="text"/>		<input type="text"/>			
DTO Name (if applicable):			Case Name (if applicable):		
<input type="text"/>			<input type="text"/>		
HIDTA Initiative:	HIDTA Initiative OR Law Enforcement Agency:				
<input type="checkbox"/> Yes <input type="checkbox"/> No	<input type="text"/>				
Squad Name:		<input type="text"/>			
Time Zone Results Requested In:		<input type="text"/>			

(b)(7)(A), (b)(7)(E)

7E-2

Phone Number	Priority	Date Range	



Hemisphere Project Request Form

Please Fax When Complete

7E-1

HIGH INTENSITY DRUG TRAFFICKING AREA
Office of National Drug Control Policy

HRC Fax (b)(7)(A),(b)(7)(E)

NEW YORK/NEW JERSEY HIDTA

Master Case Number:	<input type="text"/>	Priority:	<input type="text"/>	Current Date:	2014-05-29 10:55:20
HIDTA Point of Contact Name:		Email Results To:			
<input type="text"/>		<input type="text"/>			
POC Phone Number:		Email Notification Of Completion To:			
<input type="text"/>		<input type="text"/>			
Requestor Name:		Email Results To:			
<input type="text"/>		<input type="text"/>			
Requestor Phone Number:		Email Notification Of Completion To:			
<input type="text"/>		<input type="text"/>			
DTO Name (if applicable):			Case Name (if applicable):		
<input type="text"/>			<input type="text"/>		
HIDTA Initiative:	HIDTA Initiative OR Law Enforcement Agency:				
Yes <input type="checkbox"/> No <input type="checkbox"/>	<input type="text"/>				
Squad Name:		<input type="text"/>			
Time Zone Results Requested in:		<input type="text"/>			

(b)(7)(A) (b)(7)(E)

7E-2

Phone Number	Priority	Date Range	
<input data-bbox="290 308 497 357" type="text"/>	<input data-bbox="553 308 883 357" type="text"/>	<input data-bbox="933 308 1075 357" type="text"/>	<input data-bbox="1125 308 1270 357" type="text"/>
<input data-bbox="290 401 497 449" type="text"/>	<input data-bbox="553 401 883 449" type="text"/>	<input data-bbox="933 401 1075 449" type="text"/>	<input data-bbox="1125 401 1270 449" type="text"/>
<input data-bbox="290 493 497 541" type="text"/>	<input data-bbox="553 493 883 541" type="text"/>	<input data-bbox="933 493 1075 541" type="text"/>	<input data-bbox="1125 493 1270 541" type="text"/>
<input data-bbox="290 585 497 634" type="text"/>	<input data-bbox="553 585 883 634" type="text"/>	<input data-bbox="933 585 1075 634" type="text"/>	<input data-bbox="1125 585 1270 634" type="text"/>
<input data-bbox="290 678 497 726" type="text"/>	<input data-bbox="553 678 883 726" type="text"/>	<input data-bbox="933 678 1075 726" type="text"/>	<input data-bbox="1125 678 1270 726" type="text"/>
<input data-bbox="290 770 497 819" type="text"/>	<input data-bbox="553 770 883 819" type="text"/>	<input data-bbox="933 770 1075 819" type="text"/>	<input data-bbox="1125 770 1270 819" type="text"/>
<input data-bbox="290 863 497 911" type="text"/>	<input data-bbox="553 863 883 911" type="text"/>	<input data-bbox="933 863 1075 911" type="text"/>	<input data-bbox="1125 863 1270 911" type="text"/>
<input data-bbox="290 955 497 1003" type="text"/>	<input data-bbox="553 955 883 1003" type="text"/>	<input data-bbox="933 955 1075 1003" type="text"/>	<input data-bbox="1125 955 1270 1003" type="text"/>
<input data-bbox="290 1047 497 1096" type="text"/>	<input data-bbox="553 1047 883 1096" type="text"/>	<input data-bbox="933 1047 1075 1096" type="text"/>	<input data-bbox="1125 1047 1270 1096" type="text"/>
<input data-bbox="290 1140 497 1188" type="text"/>	<input data-bbox="553 1140 883 1188" type="text"/>	<input data-bbox="933 1140 1075 1188" type="text"/>	<input data-bbox="1125 1140 1270 1188" type="text"/>
<input data-bbox="290 1232 497 1281" type="text"/>	<input data-bbox="553 1232 883 1281" type="text"/>	<input data-bbox="933 1232 1075 1281" type="text"/>	<input data-bbox="1125 1232 1270 1281" type="text"/>
<input data-bbox="290 1325 497 1373" type="text"/>	<input data-bbox="553 1325 883 1373" type="text"/>	<input data-bbox="933 1325 1075 1373" type="text"/>	<input data-bbox="1125 1325 1270 1373" type="text"/>
<input data-bbox="290 1417 497 1465" type="text"/>	<input data-bbox="553 1417 883 1465" type="text"/>	<input data-bbox="933 1417 1075 1465" type="text"/>	<input data-bbox="1125 1417 1270 1465" type="text"/>
<input data-bbox="290 1509 497 1558" type="text"/>	<input data-bbox="553 1509 883 1558" type="text"/>	<input data-bbox="933 1509 1075 1558" type="text"/>	<input data-bbox="1125 1509 1270 1558" type="text"/>
<input data-bbox="290 1602 497 1650" type="text"/>	<input data-bbox="553 1602 883 1650" type="text"/>	<input data-bbox="933 1602 1075 1650" type="text"/>	<input data-bbox="1125 1602 1270 1650" type="text"/>
<input data-bbox="290 1694 497 1743" type="text"/>	<input data-bbox="553 1694 883 1743" type="text"/>	<input data-bbox="933 1694 1075 1743" type="text"/>	<input data-bbox="1125 1694 1270 1743" type="text"/>
<input data-bbox="290 1787 497 1835" type="text"/>	<input data-bbox="553 1787 883 1835" type="text"/>	<input data-bbox="933 1787 1075 1835" type="text"/>	<input data-bbox="1125 1787 1270 1835" type="text"/>
<input data-bbox="290 1879 497 1927" type="text"/>	<input data-bbox="553 1879 883 1927" type="text"/>	<input data-bbox="933 1879 1075 1927" type="text"/>	<input data-bbox="1125 1879 1270 1927" type="text"/>
<input data-bbox="290 1971 497 2020" type="text"/>	<input data-bbox="553 1971 883 2020" type="text"/>	<input data-bbox="933 1971 1075 2020" type="text"/>	<input data-bbox="1125 1971 1270 2020" type="text"/>



Hemisphere Project Request Form NORTH FLORIDA HIDTA

Please Fax When Complete **7E-1**

HRC Fax: (b)(7)(A), (b)(7)(E)

HIGH INTENSITY DRUG TRAFFICKING AREA
Office of National Drug Control Policy

Master Case Number:	<input type="text"/>	Priority:	<input type="text"/>	Current Date:	<input type="text" value="2014-05-29 10:55:32"/>
HIDTA Point of Contac Name:		Email Results To:			
<input type="text"/>		<input type="text"/>			
POC Phone Number:		Email Notification Of Completion To:			
<input type="text"/>		<input type="text"/>			
Requestor Name:		Email Results To:			
<input type="text"/>		<input type="text"/>			
Requestor Phone Number:		Email Notification Of Completion To:			
<input type="text"/>		<input type="text"/>			
DTO Name (if appliccable):			Case Name (if appliccable):		
<input type="text"/>			<input type="text"/>		
HIDTA Initiative:	HIDTA Initiative OR Law Enforcement Agency:	<input type="text"/>			
Yes <input type="checkbox"/> No <input type="checkbox"/>	Squad Name:	<input type="text"/>			
	Time Zone Results Requested In:	<input type="text"/>			

(b)(7)(A) (b)(7)(E)

7E-2

Phone Number	Priority	Date Range	



Hemisphere Project Request Form OHIO HIDTA

Please Fax When Complete

7E-1

HRC Fax: (b)(7)(A),(b)(7)(E)

HIGH INTENSITY DRUG TRAFFICKING AREA
Office of National Drug Control Policy

Master Case Number: Priority: Current Date:

HIDTA Point of Contact Name: Email Results To:
 POC Phone Number: Email Notification Of Completion To:

Requestor Name: Email Results To:
 Requestor Phone Number: Email Notification Of Completion To:

DTO Name (if applicable): Case Name (if applicable):

HIDTA Initiative: Yes No HIDTA Initiative OR Law Enforcement Agency:
 Squad Name:
 Time Zone Results Requested In:

(b)(7)(A) (b)(7)(E)

7E-2

Phone Number	Priority	Date Range	



Hemisphere Project Request Form

Please Fax When Complete

7E-1

HRC Fax (b)(7)(A),(b)(7)(E)

HIGH INTENSITY DRUG TRAFFICKING AREA
Office of National Drug Control Policy

PHILADELPHIA/CAMDEN HIDTA

Master Case Number: [] Priority: [] Current Date: 2014-05-29 10:55:55

HIDTA Point of Contact Name: [] Email Results To: []

POC Phone Number: [] Email Notification Of Completion To: []

Requestor Name: [] Email Results To: []

Requestor Phone Number: [] Email Notification Of Completion To: []

DTO Name (if applicable): [] Case Name (if applicable): []

HIDTA Initiative: Yes No HIDTA Initiative OR Law Enforcement Agency: []

Squad Name: []

Time Zone Results Requested In: []

(b)(7)(A), (b)(7)(E)

7E-2

Phone Number	Priority	Date Range	



Hemisphere Project Request Form

Please Fax When Complete

7E-1

HRC Fax: (b)(7)(A),(b)(7)(E)

HIGH INTENSITY DRUG TRAFFICKING AREA
Office of National Drug Control Policy

PUERTO RICO/VIRGIN IS. HIDTA

Master Case Number: Priority: Current Date:

HIDTA Point of Contact Name: Email Results To:

POC Phone Number: Email Notification Of Completion To:

Requestor Name: Email Results To:

Requestor Phone Number: Email Notification Of Completion To:

DTO Name (if applicable):

Case Name (if applicable):

HIDTA Initiative: Yes No

HIDTA Initiative OR Law Enforcement Agency:

Squad Name:

Time Zone Results Requested In:

(b)(7)(A),(b)(7)(E)

7E-2

Phone Number	Priority	Date Range	
<input data-bbox="294 302 505 352" type="text"/>	<input data-bbox="558 302 893 352" type="text"/>	<input data-bbox="938 310 1087 361" type="text"/>	<input data-bbox="1129 310 1278 361" type="text"/>
<input data-bbox="294 394 505 445" type="text"/>	<input data-bbox="558 394 893 445" type="text"/>	<input data-bbox="938 403 1087 453" type="text"/>	<input data-bbox="1129 403 1278 453" type="text"/>
<input data-bbox="294 487 505 537" type="text"/>	<input data-bbox="558 487 893 537" type="text"/>	<input data-bbox="938 495 1087 546" type="text"/>	<input data-bbox="1129 495 1278 546" type="text"/>
<input data-bbox="294 579 505 630" type="text"/>	<input data-bbox="558 579 893 630" type="text"/>	<input data-bbox="938 588 1087 638" type="text"/>	<input data-bbox="1129 588 1278 638" type="text"/>
<input data-bbox="294 672 505 722" type="text"/>	<input data-bbox="558 672 893 722" type="text"/>	<input data-bbox="938 680 1087 730" type="text"/>	<input data-bbox="1129 680 1278 730" type="text"/>
<input data-bbox="294 764 505 814" type="text"/>	<input data-bbox="558 764 893 814" type="text"/>	<input data-bbox="938 772 1087 823" type="text"/>	<input data-bbox="1129 772 1278 823" type="text"/>
<input data-bbox="294 856 505 907" type="text"/>	<input data-bbox="558 856 893 907" type="text"/>	<input data-bbox="938 865 1087 915" type="text"/>	<input data-bbox="1129 865 1278 915" type="text"/>
<input data-bbox="294 949 505 999" type="text"/>	<input data-bbox="558 949 893 999" type="text"/>	<input data-bbox="938 957 1087 1008" type="text"/>	<input data-bbox="1129 957 1278 1008" type="text"/>
<input data-bbox="294 1041 505 1092" type="text"/>	<input data-bbox="558 1041 893 1092" type="text"/>	<input data-bbox="938 1050 1087 1100" type="text"/>	<input data-bbox="1129 1050 1278 1100" type="text"/>
<input data-bbox="294 1134 505 1184" type="text"/>	<input data-bbox="558 1134 893 1184" type="text"/>	<input data-bbox="938 1142 1087 1192" type="text"/>	<input data-bbox="1129 1142 1278 1192" type="text"/>
<input data-bbox="294 1226 505 1276" type="text"/>	<input data-bbox="558 1226 893 1276" type="text"/>	<input data-bbox="938 1234 1087 1285" type="text"/>	<input data-bbox="1129 1234 1278 1285" type="text"/>
<input data-bbox="294 1318 505 1369" type="text"/>	<input data-bbox="558 1318 893 1369" type="text"/>	<input data-bbox="938 1327 1087 1377" type="text"/>	<input data-bbox="1129 1327 1278 1377" type="text"/>
<input data-bbox="294 1411 505 1461" type="text"/>	<input data-bbox="558 1411 893 1461" type="text"/>	<input data-bbox="938 1419 1087 1470" type="text"/>	<input data-bbox="1129 1419 1278 1470" type="text"/>
<input data-bbox="294 1503 505 1554" type="text"/>	<input data-bbox="558 1503 893 1554" type="text"/>	<input data-bbox="938 1512 1087 1562" type="text"/>	<input data-bbox="1129 1512 1278 1562" type="text"/>
<input data-bbox="294 1596 505 1646" type="text"/>	<input data-bbox="558 1596 893 1646" type="text"/>	<input data-bbox="938 1604 1087 1654" type="text"/>	<input data-bbox="1129 1604 1278 1654" type="text"/>
<input data-bbox="294 1688 505 1738" type="text"/>	<input data-bbox="558 1688 893 1738" type="text"/>	<input data-bbox="938 1696 1087 1747" type="text"/>	<input data-bbox="1129 1696 1278 1747" type="text"/>
<input data-bbox="294 1780 505 1831" type="text"/>	<input data-bbox="558 1780 893 1831" type="text"/>	<input data-bbox="938 1789 1087 1839" type="text"/>	<input data-bbox="1129 1789 1278 1839" type="text"/>
<input data-bbox="294 1873 505 1923" type="text"/>	<input data-bbox="558 1873 893 1923" type="text"/>	<input data-bbox="938 1881 1087 1932" type="text"/>	<input data-bbox="1129 1881 1278 1932" type="text"/>
<input data-bbox="294 1965 505 2016" type="text"/>	<input data-bbox="558 1965 893 2016" type="text"/>	<input data-bbox="938 1974 1087 2024" type="text"/>	<input data-bbox="1129 1974 1278 2024" type="text"/>



Hemisphere Project Request Form SOUTH FLORIDA HIDTA

Please Fax When Complete

South Florida ISC Fax: 7E-1

HIGH INTENSITY DRUG TRAFFICKING AREA
Office of National Drug Control Policy

(b)(7)(A),(b)(7)(E)

Master Case Number: Priority: Current Date:

HIDTA Point of Contact Name: Email Results To:

POC Phone Number:

Email Notification Of Completion To:

Requestor Name:

Email Results To:

Requestor Phone Number:

Email Notification Of Completion To:

DTO Name (if applicable):

Case Name (if applicable):

HIDTA Initiative: Yes No

HIDTA Initiative OR Law Enforcement Agency:

Squad Name:

Time Zone Results Requested in:

(b)(7)(A) (b)(7)(E)

7E-2

Phone Number	Priority	Date Range	
<input data-bbox="299 300 508 352" type="text"/>	<input data-bbox="558 300 895 352" type="text"/>	<input data-bbox="944 310 1087 363" type="text"/>	<input data-bbox="1136 310 1280 363" type="text"/>
<input data-bbox="299 394 508 447" type="text"/>	<input data-bbox="558 394 895 447" type="text"/>	<input data-bbox="944 405 1087 457" type="text"/>	<input data-bbox="1136 405 1280 457" type="text"/>
<input data-bbox="299 489 508 541" type="text"/>	<input data-bbox="558 489 895 541" type="text"/>	<input data-bbox="944 499 1087 552" type="text"/>	<input data-bbox="1136 499 1280 552" type="text"/>
<input data-bbox="299 573 508 625" type="text"/>	<input data-bbox="558 573 895 625" type="text"/>	<input data-bbox="944 583 1087 636" type="text"/>	<input data-bbox="1136 583 1280 636" type="text"/>
<input data-bbox="299 667 508 720" type="text"/>	<input data-bbox="558 667 895 720" type="text"/>	<input data-bbox="944 678 1087 730" type="text"/>	<input data-bbox="1136 678 1280 730" type="text"/>
<input data-bbox="299 762 508 814" type="text"/>	<input data-bbox="558 762 895 814" type="text"/>	<input data-bbox="944 772 1087 825" type="text"/>	<input data-bbox="1136 772 1280 825" type="text"/>
<input data-bbox="299 856 508 909" type="text"/>	<input data-bbox="558 856 895 909" type="text"/>	<input data-bbox="944 867 1087 919" type="text"/>	<input data-bbox="1136 867 1280 919" type="text"/>
<input data-bbox="299 951 508 1003" type="text"/>	<input data-bbox="558 951 895 1003" type="text"/>	<input data-bbox="944 961 1087 1014" type="text"/>	<input data-bbox="1136 961 1280 1014" type="text"/>
<input data-bbox="299 1035 508 1087" type="text"/>	<input data-bbox="558 1035 895 1087" type="text"/>	<input data-bbox="944 1045 1087 1098" type="text"/>	<input data-bbox="1136 1045 1280 1098" type="text"/>
<input data-bbox="299 1129 508 1182" type="text"/>	<input data-bbox="558 1129 895 1182" type="text"/>	<input data-bbox="944 1140 1087 1192" type="text"/>	<input data-bbox="1136 1140 1280 1192" type="text"/>
<input data-bbox="299 1224 508 1276" type="text"/>	<input data-bbox="558 1224 895 1276" type="text"/>	<input data-bbox="944 1234 1087 1287" type="text"/>	<input data-bbox="1136 1234 1280 1287" type="text"/>
<input data-bbox="299 1318 508 1371" type="text"/>	<input data-bbox="558 1318 895 1371" type="text"/>	<input data-bbox="944 1329 1087 1381" type="text"/>	<input data-bbox="1136 1329 1280 1381" type="text"/>
<input data-bbox="299 1413 508 1465" type="text"/>	<input data-bbox="558 1413 895 1465" type="text"/>	<input data-bbox="944 1423 1087 1476" type="text"/>	<input data-bbox="1136 1423 1280 1476" type="text"/>
<input data-bbox="299 1507 508 1560" type="text"/>	<input data-bbox="558 1507 895 1560" type="text"/>	<input data-bbox="944 1518 1087 1570" type="text"/>	<input data-bbox="1136 1518 1280 1570" type="text"/>
<input data-bbox="299 1602 508 1654" type="text"/>	<input data-bbox="558 1602 895 1654" type="text"/>	<input data-bbox="944 1612 1087 1665" type="text"/>	<input data-bbox="1136 1612 1280 1665" type="text"/>
<input data-bbox="299 1696 508 1749" type="text"/>	<input data-bbox="558 1696 895 1749" type="text"/>	<input data-bbox="944 1707 1087 1759" type="text"/>	<input data-bbox="1136 1707 1280 1759" type="text"/>
<input data-bbox="299 1791 508 1843" type="text"/>	<input data-bbox="558 1791 895 1843" type="text"/>	<input data-bbox="944 1801 1087 1854" type="text"/>	<input data-bbox="1136 1801 1280 1854" type="text"/>
<input data-bbox="299 1885 508 1938" type="text"/>	<input data-bbox="558 1885 895 1938" type="text"/>	<input data-bbox="944 1896 1087 1948" type="text"/>	<input data-bbox="1136 1896 1280 1948" type="text"/>
<input data-bbox="299 1980 508 2032" type="text"/>	<input data-bbox="558 1980 895 2032" type="text"/>	<input data-bbox="944 1990 1087 2043" type="text"/>	<input data-bbox="1136 1990 1280 2043" type="text"/>



Hemisphere Project Request Form

Please Fax When Complete

7E-1

HRC Fax: (b)(7)(A), (b)(7)(E)

HIGH INTENSITY DRUG TRAFFICKING AREA
Office of National Drug Control Policy

WASHINGTON/BALTIMORE HIDTA

Master Case Number: [] Priority: [] Current Date: 2014-05-29 10:56:31

HIDTA Point of Contac Name: [] Email Results To: []

POC Phone Number: [] Email Notification Of Completion To: []

Requestor Name: [] Email Results To: []

Requestor Phone Number: [] Email Notification Of Completion To: []

DTO Name (if applicable): [] Case Name (if applicable): []

HIDTA Initiative: [] HIDTA Initiative OR Law Enforcement Agency: []

Yes No Squad Name: []

Time Zone Results Requested in: []

(b)(7)(A) (b)(7)(E)

7E-2

Phone Number	Priority	Date Range	
<input type="text"/>	<input type="text"/>	<input type="text"/>	<input type="text"/>
<input type="text"/>	<input type="text"/>	<input type="text"/>	<input type="text"/>
<input type="text"/>	<input type="text"/>	<input type="text"/>	<input type="text"/>
<input type="text"/>	<input type="text"/>	<input type="text"/>	<input type="text"/>
<input type="text"/>	<input type="text"/>	<input type="text"/>	<input type="text"/>
<input type="text"/>	<input type="text"/>	<input type="text"/>	<input type="text"/>
<input type="text"/>	<input type="text"/>	<input type="text"/>	<input type="text"/>
<input type="text"/>	<input type="text"/>	<input type="text"/>	<input type="text"/>
<input type="text"/>	<input type="text"/>	<input type="text"/>	<input type="text"/>
<input type="text"/>	<input type="text"/>	<input type="text"/>	<input type="text"/>
<input type="text"/>	<input type="text"/>	<input type="text"/>	<input type="text"/>
<input type="text"/>	<input type="text"/>	<input type="text"/>	<input type="text"/>
<input type="text"/>	<input type="text"/>	<input type="text"/>	<input type="text"/>
<input type="text"/>	<input type="text"/>	<input type="text"/>	<input type="text"/>
<input type="text"/>	<input type="text"/>	<input type="text"/>	<input type="text"/>
<input type="text"/>	<input type="text"/>	<input type="text"/>	<input type="text"/>
<input type="text"/>	<input type="text"/>	<input type="text"/>	<input type="text"/>
<input type="text"/>	<input type="text"/>	<input type="text"/>	<input type="text"/>
<input type="text"/>	<input type="text"/>	<input type="text"/>	<input type="text"/>
<input type="text"/>	<input type="text"/>	<input type="text"/>	<input type="text"/>
<input type="text"/>	<input type="text"/>	<input type="text"/>	<input type="text"/>
<input type="text"/>	<input type="text"/>	<input type="text"/>	<input type="text"/>

Hemisphere and Privacy

- Hemisphere is subpoena/court order driven access to business records (court order required to [redacted])
- Records are held by the telecommunications provider as their routine business records and are not directly available to investigators and supporting case analysts except those subject to legal process

[redacted]

Law Enforcement Sensitive

(b)(7)(A), (b)(7)(E)

7E-3

7E-2

- Federal courts have consistently held to the Third Party rule

Hemisphere and Privacy

7E-3

(b)(7)(A),(b)(7)(E)

7E-2

Law Enforcement Sensitive



HIGH INTENSITY DRUG TRAFFICKING AREA
Office of National Drug Control Policy

Hemisphere Project Request Form HOUSTON HIDTA

Please Fax When Complete

7E-1

HRC Fax : (b)(7)(A), (b)(7)(E)

Master Case Number:	<input type="text"/>	Priority:	<input type="text"/>	Current Date:	2013-12-02 09:32:52
----------------------------	----------------------	------------------	----------------------	----------------------	---------------------

HIDTA Point of Contact Name: **Email Results To:**

<input type="text"/>	<input type="text"/>
----------------------	----------------------

POC Phone Number:

Email Notification Of Completion To:

<input type="text"/>	<input type="text"/>
----------------------	----------------------

Requestor Name:

Email Results To:

<input type="text"/>	<input type="text"/>
----------------------	----------------------

Requestor Phone Number:

Email Notification Of Completion To:

<input type="text"/>	<input type="text"/>
----------------------	----------------------

DTO Name (if applicable):

Case Name (if applicable):

<input type="text"/>	<input type="text"/>
----------------------	----------------------

HIDTA Initiative:

HIDTA Initiative OR Law Enforcement Agency:

Yes No

Squad Name:

Time Zone Results Requested in:

<input type="text"/>
<input type="text"/>
<input type="text"/>

(b)(7)(A) (b)(7)(E)

7E-2

Phone Number	Priority	Date Range	
<input type="text"/>	<input type="text"/>	<input type="text"/>	<input type="text"/>
<input type="text"/>	<input type="text"/>	<input type="text"/>	<input type="text"/>
<input type="text"/>	<input type="text"/>	<input type="text"/>	<input type="text"/>
<input type="text"/>	<input type="text"/>	<input type="text"/>	<input type="text"/>
<input type="text"/>	<input type="text"/>	<input type="text"/>	<input type="text"/>
<input type="text"/>	<input type="text"/>	<input type="text"/>	<input type="text"/>
<input type="text"/>	<input type="text"/>	<input type="text"/>	<input type="text"/>
<input type="text"/>	<input type="text"/>	<input type="text"/>	<input type="text"/>
<input type="text"/>	<input type="text"/>	<input type="text"/>	<input type="text"/>
<input type="text"/>	<input type="text"/>	<input type="text"/>	<input type="text"/>
<input type="text"/>	<input type="text"/>	<input type="text"/>	<input type="text"/>
<input type="text"/>	<input type="text"/>	<input type="text"/>	<input type="text"/>
<input type="text"/>	<input type="text"/>	<input type="text"/>	<input type="text"/>
<input type="text"/>	<input type="text"/>	<input type="text"/>	<input type="text"/>
<input type="text"/>	<input type="text"/>	<input type="text"/>	<input type="text"/>
<input type="text"/>	<input type="text"/>	<input type="text"/>	<input type="text"/>
<input type="text"/>	<input type="text"/>	<input type="text"/>	<input type="text"/>
<input type="text"/>	<input type="text"/>	<input type="text"/>	<input type="text"/>
<input type="text"/>	<input type="text"/>	<input type="text"/>	<input type="text"/>
<input type="text"/>	<input type="text"/>	<input type="text"/>	<input type="text"/>

(b)(7)(A), (b)(7)(D), (b)(7)(E), (b)(7)(F)



HEMISPHERE SUBPOENA-

Official Language

All Hemisphere subpoenas should have the following in the recipient / address section...

7E-2

7D-1, 7E-6

(b)(7)(A), (b)(7)
(E)



HEMISPHERE SUBPOENA-
Official Language

7E-2



HOUSTON HIDTA
HIGH INTENSITY DRUG TRAFFICKING AREA
Office of National Drug Control Policy

Hemisphere Project Request Form

Please Fax When Complete

7E-1

HISC Fax : (b)(7)(A), (b)(7)(E)

Master Case Number: Sub-Case Number: Date/Time:

DTO Name (if applicable): Case Name (if applicable):

HIDTA Initiative: Yes No HIDTA Initiative OR Law Enforcement Agency:
Squad Name:

From: Secure Phone Number: Priority:
To: Deliver Results To:

Email Address:

(b)(7)(A), (b)(7)(E)

7E-2

Phone Number	Previous Tasking Info	Priority	Date Range	
<input type="text"/>	<input type="checkbox"/>	<input type="text"/>	<input type="text"/>	<input type="text"/>
<input type="text"/>	<input type="checkbox"/>	<input type="text"/>	<input type="text"/>	<input type="text"/>
<input type="text"/>	<input type="checkbox"/>	<input type="text"/>	<input type="text"/>	<input type="text"/>
<input type="text"/>	<input type="checkbox"/>	<input type="text"/>	<input type="text"/>	<input type="text"/>
<input type="text"/>	<input type="checkbox"/>	<input type="text"/>	<input type="text"/>	<input type="text"/>
<input type="text"/>	<input type="checkbox"/>	<input type="text"/>	<input type="text"/>	<input type="text"/>
<input type="text"/>	<input type="checkbox"/>	<input type="text"/>	<input type="text"/>	<input type="text"/>
<input type="text"/>	<input type="checkbox"/>	<input type="text"/>	<input type="text"/>	<input type="text"/>
<input type="text"/>	<input type="checkbox"/>	<input type="text"/>	<input type="text"/>	<input type="text"/>
<input type="text"/>	<input type="checkbox"/>	<input type="text"/>	<input type="text"/>	<input type="text"/>
<input type="text"/>	<input type="checkbox"/>	<input type="text"/>	<input type="text"/>	<input type="text"/>
<input type="text"/>	<input type="checkbox"/>	<input type="text"/>	<input type="text"/>	<input type="text"/>
<input type="text"/>	<input type="checkbox"/>	<input type="text"/>	<input type="text"/>	<input type="text"/>
<input type="text"/>	<input type="checkbox"/>	<input type="text"/>	<input type="text"/>	<input type="text"/>
<input type="text"/>	<input type="checkbox"/>	<input type="text"/>	<input type="text"/>	<input type="text"/>
<input type="text"/>	<input type="checkbox"/>	<input type="text"/>	<input type="text"/>	<input type="text"/>
<input type="text"/>	<input type="checkbox"/>	<input type="text"/>	<input type="text"/>	<input type="text"/>
<input type="text"/>	<input type="checkbox"/>	<input type="text"/>	<input type="text"/>	<input type="text"/>
<input type="text"/>	<input type="checkbox"/>	<input type="text"/>	<input type="text"/>	<input type="text"/>
<input type="text"/>	<input type="checkbox"/>	<input type="text"/>	<input type="text"/>	<input type="text"/>
<input type="text"/>	<input type="checkbox"/>	<input type="text"/>	<input type="text"/>	<input type="text"/>

(b)(6),(b)(7)(A),(b)(7)(C),(b)(7)(D),(b)(7)(E),(b)(7)(F)

PAGE 01/04

[Redacted]

U.S. DEPARTMENT OF JUSTICE / DRUG ENFORCEMENT ADMINISTRATION
SUBPOENA
In the matter of the investigation of

7D-1, 7E-6

7E-2

[Redacted]

[Redacted]

[Redacted]

6-1, 7C-1, 7E-8, 7F-1

[Redacted]

7E-2

7E-3

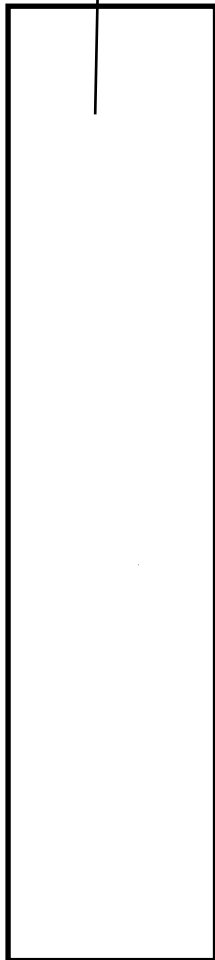

(b)(6), (b)(7)(A), (b)(7)(C), (b)(7)(D), (b)(7)(E), (b)(7)(F)

(b)(5),(b)(7)(A),(b)(7)(D),(b)(7)(E),(b)(7)(F)

5-1

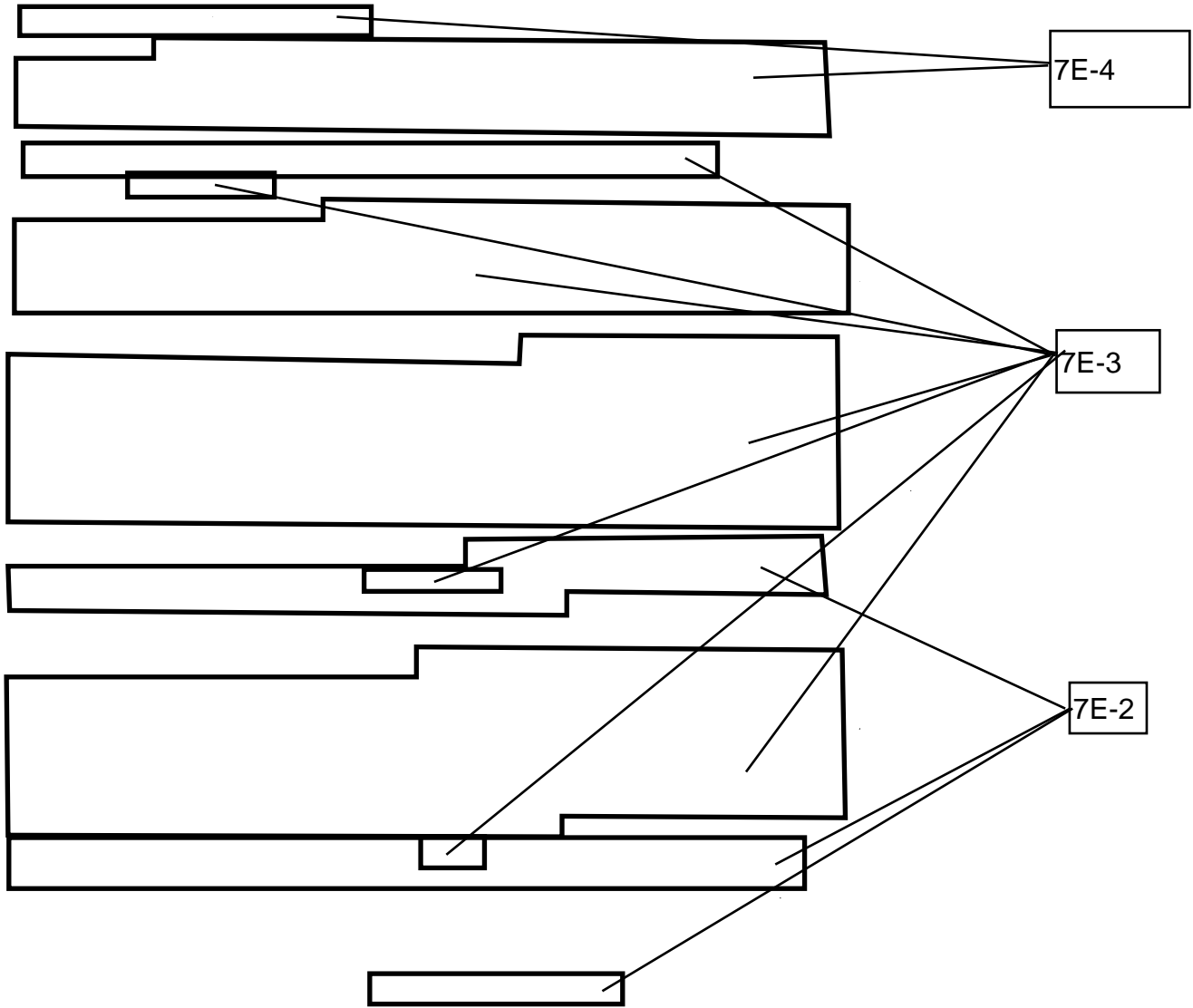

(b)(5),(b)(7)(A),(b)(7)(D),(b)(7)(E),(b)(7)(F)

5-1

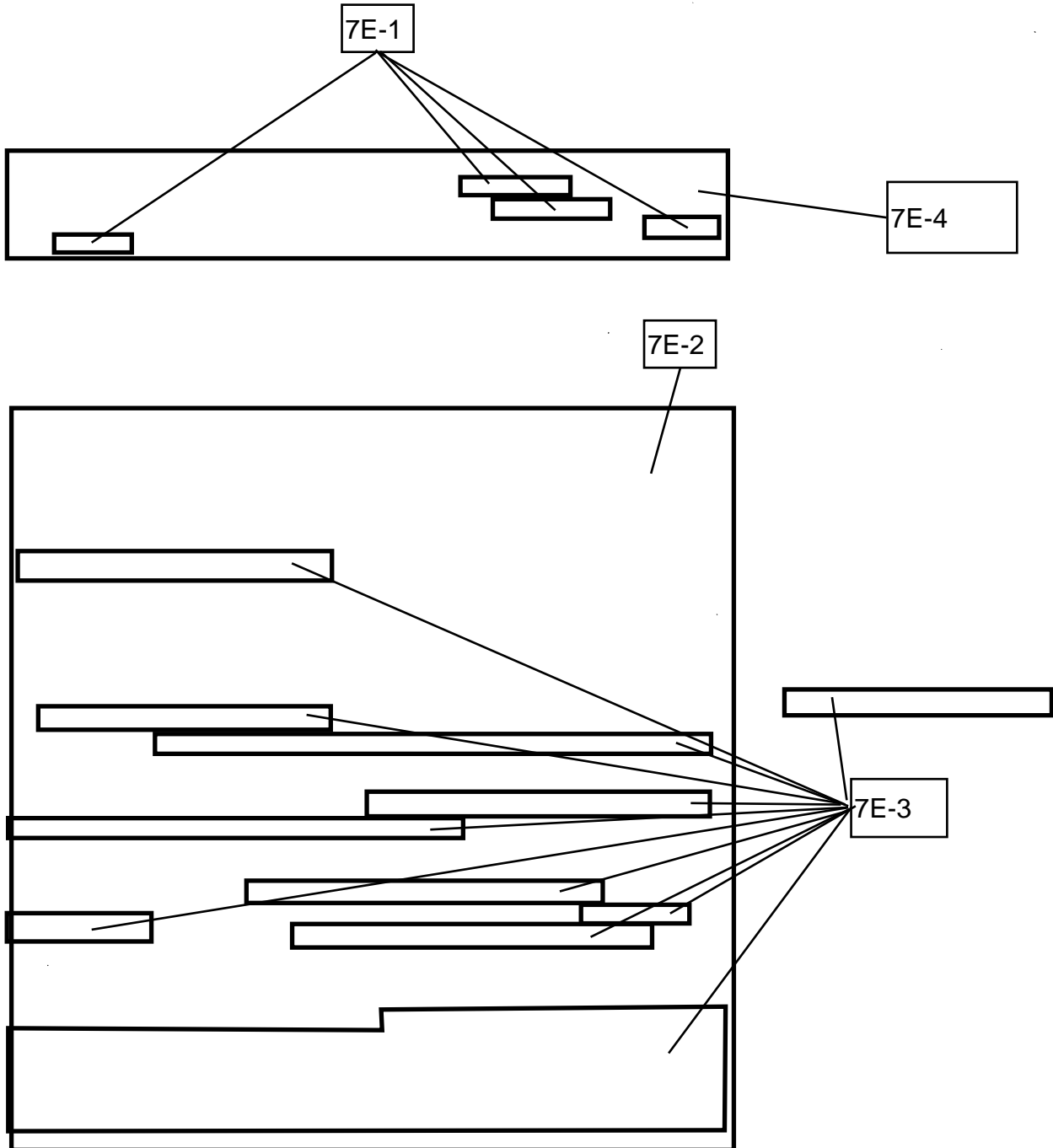

(b)(5),(b)(6),(b)(7)(A),(b)(7)(C),(b)(7)(D),(b)(7)(E),(b)(7)(F)

5-1

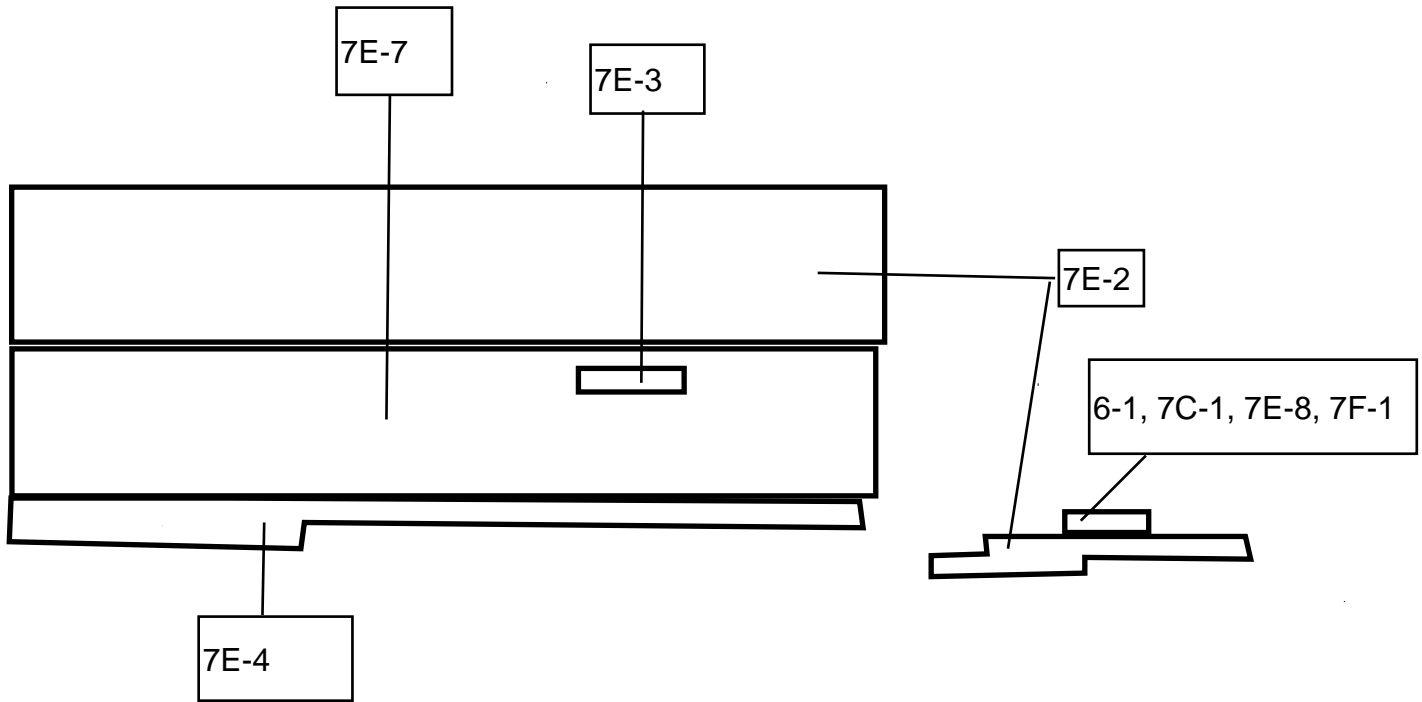

(b)(5),(b)(7)(A),(b)(7)(C),(b)(7)(D),(b)(7)(E),(b)(7)(F)

5-1

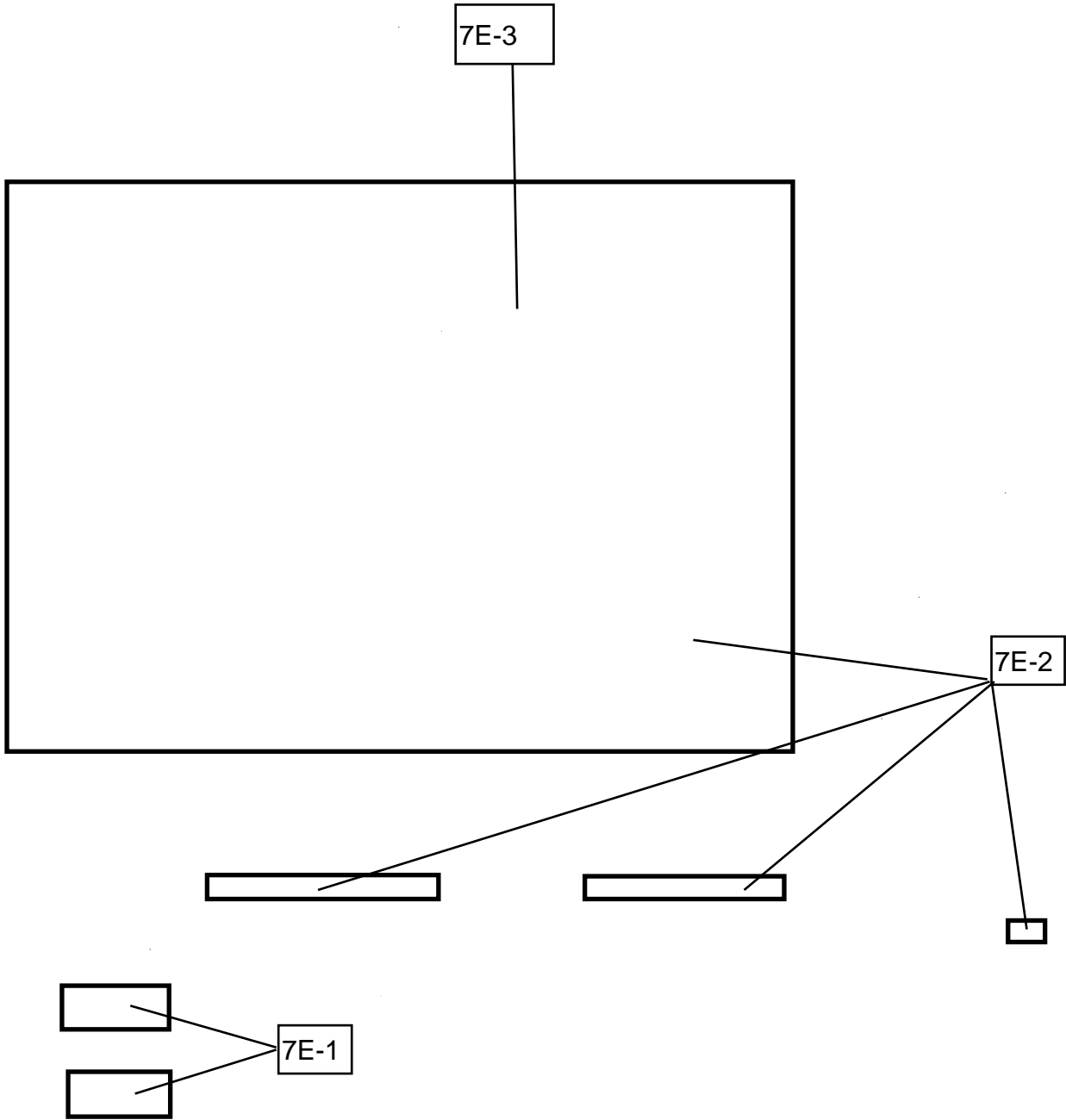

(b)(5), (b)(7)(A), (b)(7)(C), (b)(7)(D), (b)(7)(E), (b)(7)(F)

5-1

7E-1



7E-5



7E-2

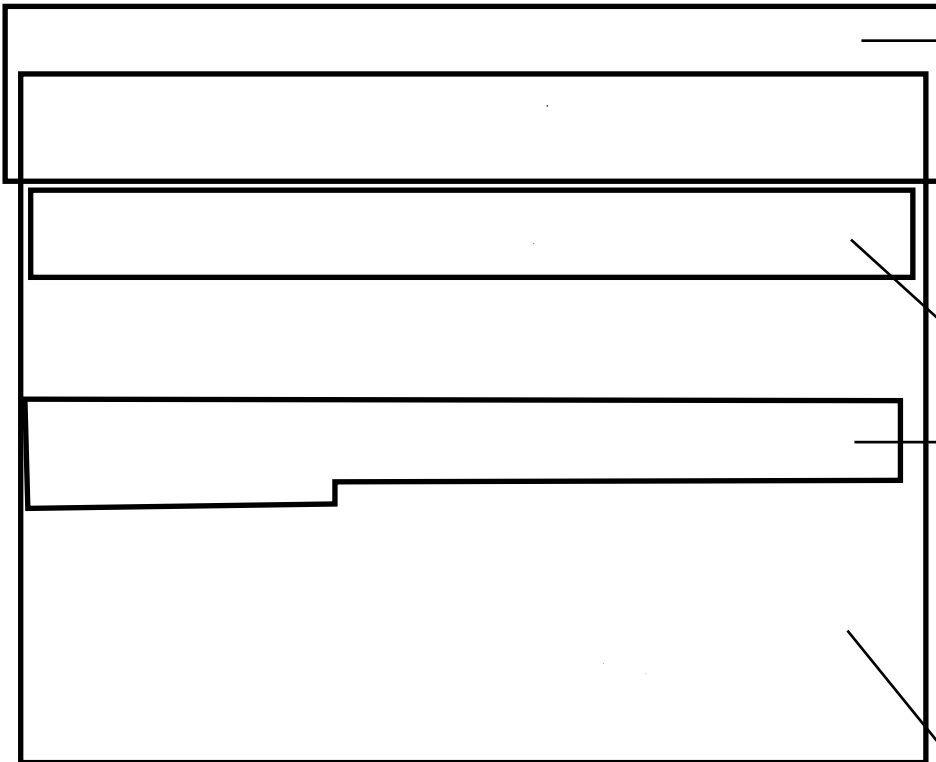

7E-7

7E-3

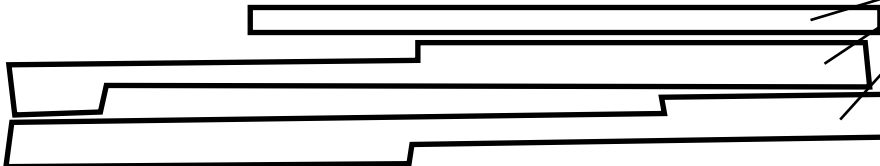

(b)(5),(b)(7)(A),(b)(7)(D),(b)(7)(E)

5-1

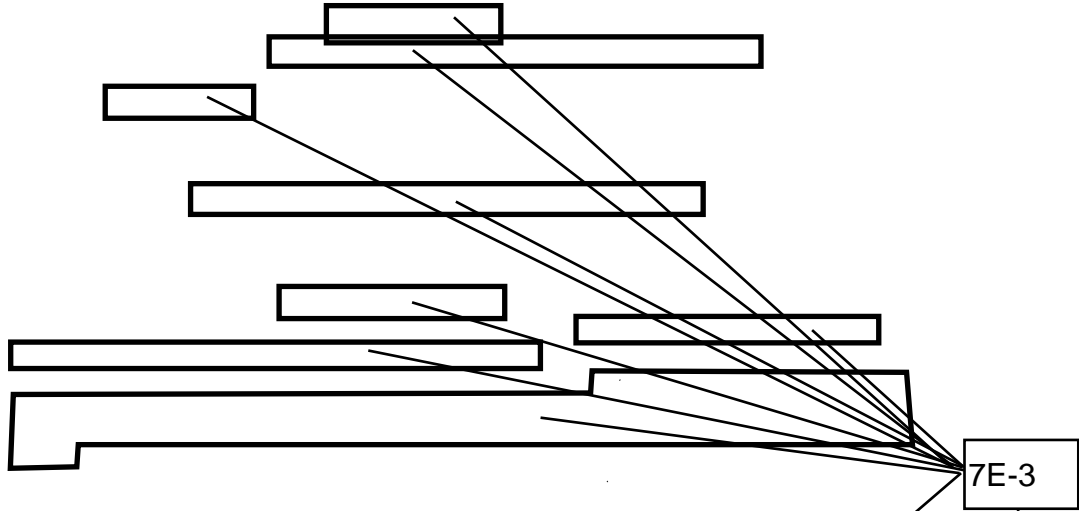

7E-2

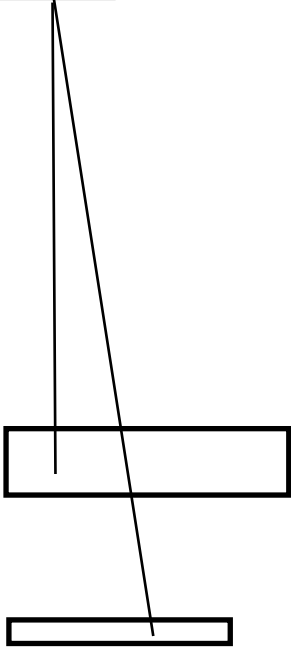
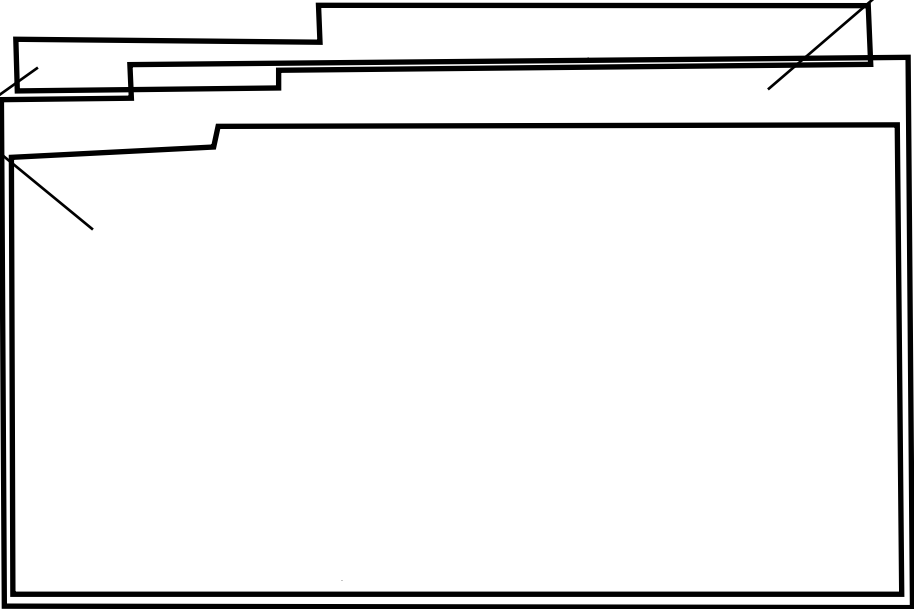

(b)(5),(b)(7)(A),(b)(7)(D),(b)(7)(E)

5-1

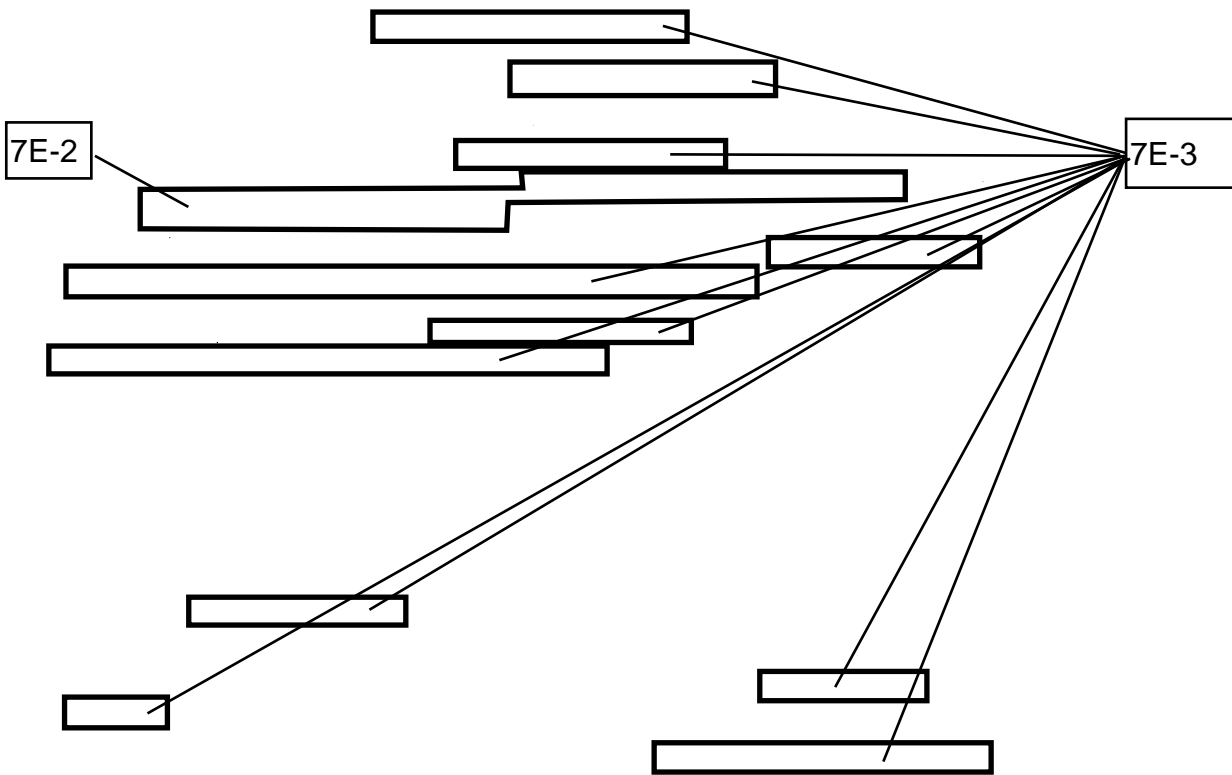

(b)(5),(b)(7)(A),(b)(7)(D),(b)(7)(E)

5-1

7E-3

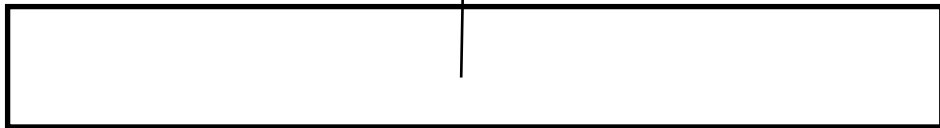

(b)(5), (b)(7)(A), (b)(7)(C), (b)(7)(D), (b)(7)(E), (b)(7)(F)

5-1

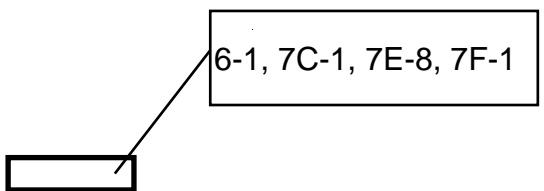
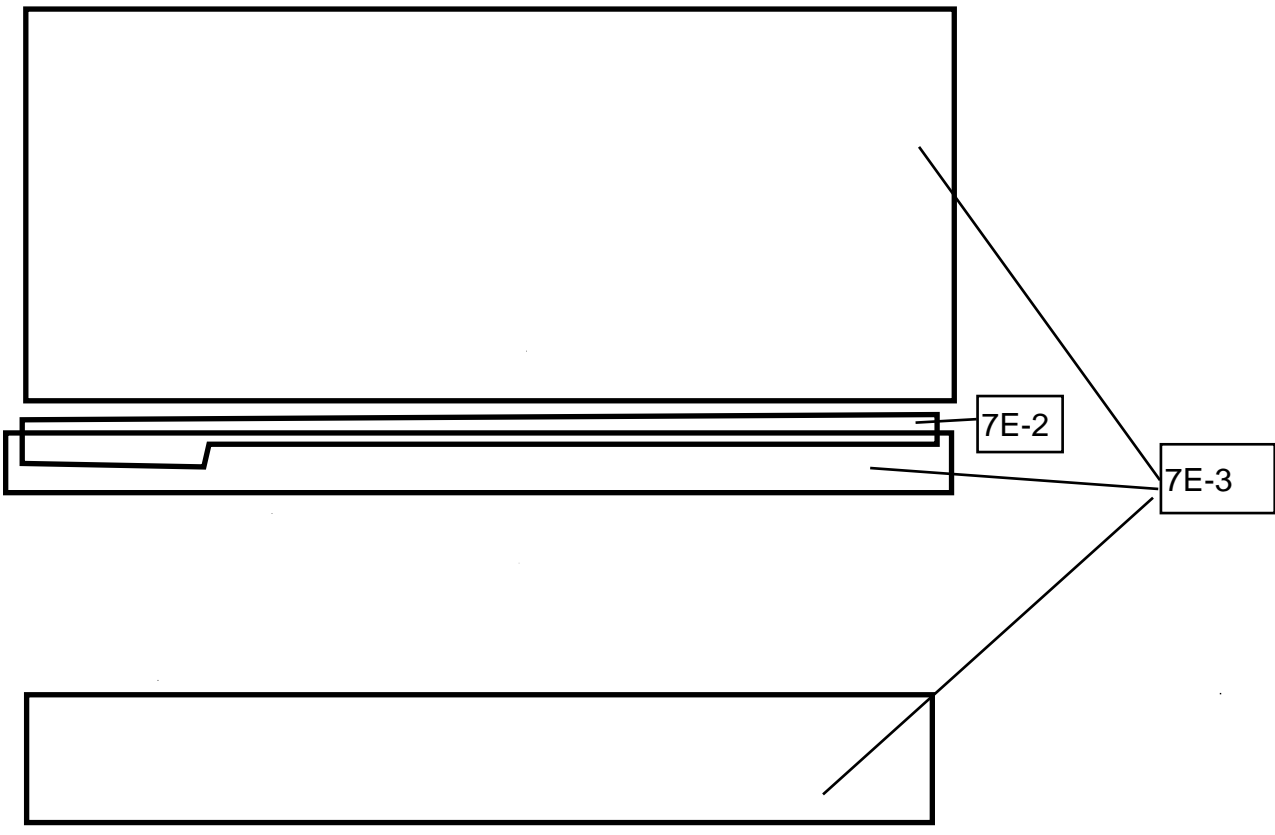

(b)(5),(b)(7)(A),(b)(7)(D),(b)(7)(E)

5-1

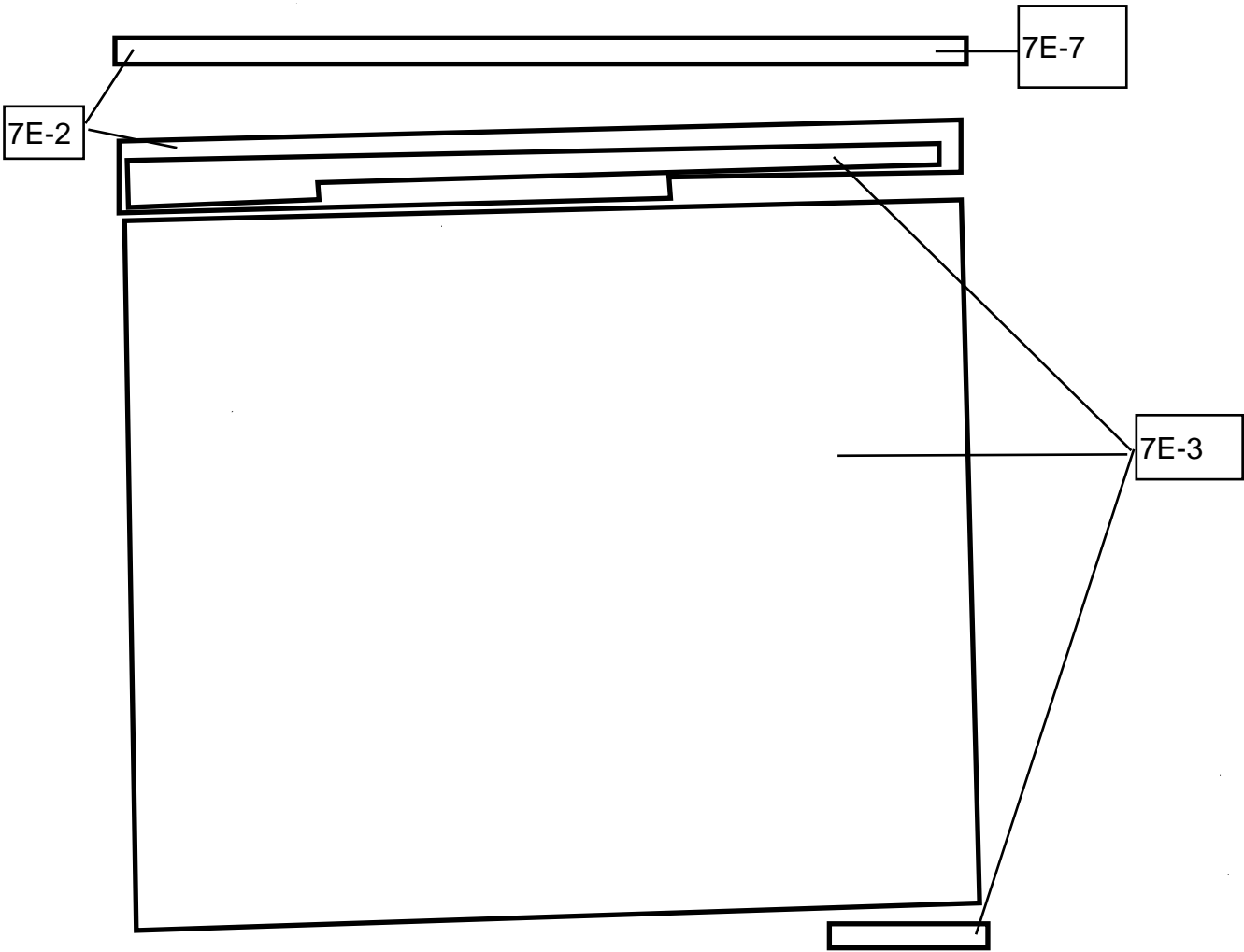

(b)(5),(b)(7)(A),(b)(7)(D),(b)(7)(E)

5-1

7E-2

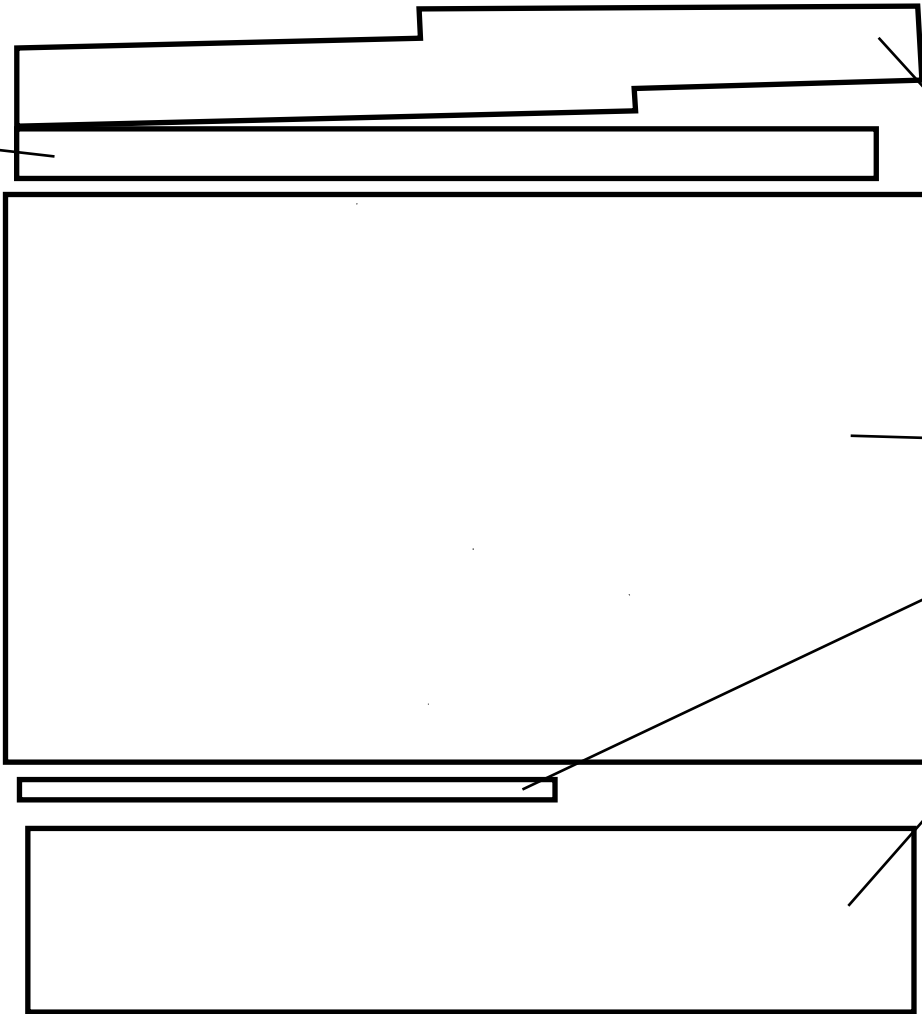

7E-3

(b)(5),(b)(7)(A),(b)(7)(D),(b)(7)(E)

5-1

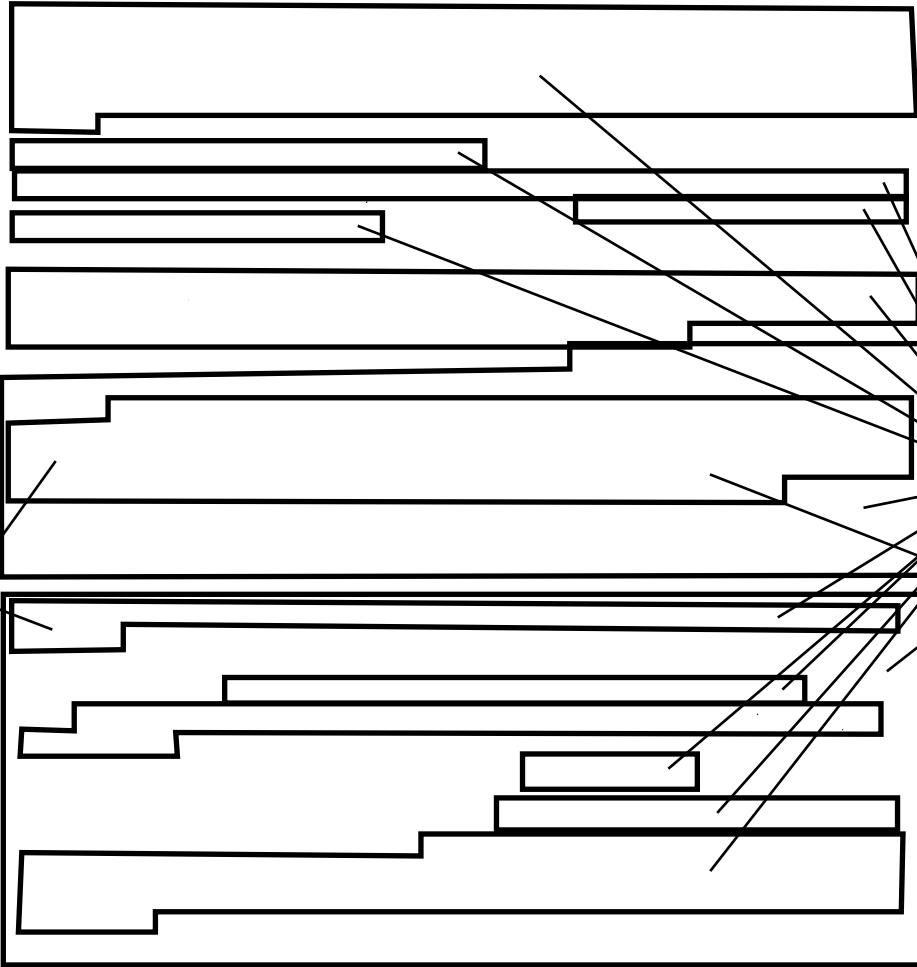

7E-7

7E-3

7E-2

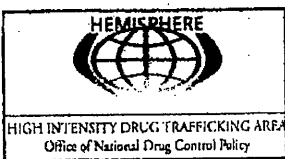

Hemisphere Project Request Form

Please Fax When Complete
ISC Fax: (b)(7)(A), (b)(7)(E)

7E-1

Master Case Number:	<input type="text"/>	Sub-Case Number:	<input type="text"/>	Date/Time:	<input type="text"/>
From:	Email Results To:		Priority:		
<input type="text"/>	<input type="text"/>		<input type="text"/>		
Secure Phone Number:	Email Notification Of Completion To:				
<input type="text"/>	<input type="text"/>				
DTO Name (if applicable):			Case Name (if applicable):		
<input type="text"/>			<input type="text"/>		
HIDTA Initiative:	HIDTA Initiative OR Law Enforcement Agency:				
Yes <input type="checkbox"/> No <input type="checkbox"/>	<input type="text"/>				
	Squad Name:				
	<input type="text"/>				
	Time Zone Results Requested In:				
	<input type="text"/>				

(b)(7)(A) (b)(7)(E)

7E-2

Phone Number	Priority	Date Range	



HIGH INTENSITY DRUG TRAFFICKING AREA
Office of National Drug Control Policy

Hemisphere Project Request Form

Please Fax When Complete

7E-1

LACLEAR Hemisphere Fax: (b)(7)(A), (b)(7)(C), (b)(7)(E)

Questions? Phone: (b)(7)(A), (b)(7)(C), (b)(7)(E)

Master Case Number:	<input type="text"/>	Sub- Case Number:	<input type="text"/>	Date:	<input type="text"/>
Drug Type Associated with Investigation:	Narcotic Related		Priority:	<input type="text"/>	
Submitting Agent/Analyst:	<input type="text"/>		Secure Phone Number:	<input type="text"/>	
Lead Case Agent if Different from Above:	<input type="text"/>				
Lead Case Agent Phone Number:	<input type="text"/>				
E-mail Results To:	<input type="text"/>		E-mail Notification of Completion To:	<input type="text"/>	
Drug Trafficking Organization/Name (if applicable):	<input type="text"/>				
Case Name (if applicable):	<input type="text"/>				
HIDTA Initiative: Yes <input type="checkbox"/> No <input type="checkbox"/>					
HIDTA Initiative OR Law Enforcement Agency:	<input type="text"/>				
Squad Name:	<input type="text"/>				
Time Zone Results Requested in:	<input type="text"/>				

(b)(7)(A) (b)(7)(E)

7E-2



HOUSTON HIDTA
HIGH INTENSITY DRUG TRAFFICKING AREA
Office of National Drug Control Policy

Hemisphere Project Request Form

Please Fax When Complete

7E-1

HISC Fax: (b)(7)(A),(b)(7)(E)

Master Case Number: Sub-Case Number: Date/Time:

DTO Name (if applicable): Case Name (if applicable):

HIDTA Initiative: Yes No HIDTA Initiative OR Law Enforcement Agency:
Squad Name:

From: Secure Phone Number: Priority:
To: Deliver Results To:

Email Address:

(b)(7)(A),(b)(7)(E)

[Large empty rectangular area for request details]

7E-2

Phone Number	Previous Tasking Info	Priority	Date Range	
<input type="text"/>	<input type="checkbox"/> <input type="text"/>	<input type="text"/>	<input type="text"/>	<input type="text"/>
<input type="text"/>	<input type="checkbox"/> <input type="text"/>	<input type="text"/>	<input type="text"/>	<input type="text"/>
<input type="text"/>	<input type="checkbox"/> <input type="text"/>	<input type="text"/>	<input type="text"/>	<input type="text"/>
<input type="text"/>	<input type="checkbox"/> <input type="text"/>	<input type="text"/>	<input type="text"/>	<input type="text"/>
<input type="text"/>	<input type="checkbox"/> <input type="text"/>	<input type="text"/>	<input type="text"/>	<input type="text"/>
<input type="text"/>	<input type="checkbox"/> <input type="text"/>	<input type="text"/>	<input type="text"/>	<input type="text"/>
<input type="text"/>	<input type="checkbox"/> <input type="text"/>	<input type="text"/>	<input type="text"/>	<input type="text"/>
<input type="text"/>	<input type="checkbox"/> <input type="text"/>	<input type="text"/>	<input type="text"/>	<input type="text"/>
<input type="text"/>	<input type="checkbox"/> <input type="text"/>	<input type="text"/>	<input type="text"/>	<input type="text"/>
<input type="text"/>	<input type="checkbox"/> <input type="text"/>	<input type="text"/>	<input type="text"/>	<input type="text"/>
<input type="text"/>	<input type="checkbox"/> <input type="text"/>	<input type="text"/>	<input type="text"/>	<input type="text"/>
<input type="text"/>	<input type="checkbox"/> <input type="text"/>	<input type="text"/>	<input type="text"/>	<input type="text"/>
<input type="text"/>	<input type="checkbox"/> <input type="text"/>	<input type="text"/>	<input type="text"/>	<input type="text"/>
<input type="text"/>	<input type="checkbox"/> <input type="text"/>	<input type="text"/>	<input type="text"/>	<input type="text"/>
<input type="text"/>	<input type="checkbox"/> <input type="text"/>	<input type="text"/>	<input type="text"/>	<input type="text"/>
<input type="text"/>	<input type="checkbox"/> <input type="text"/>	<input type="text"/>	<input type="text"/>	<input type="text"/>
<input type="text"/>	<input type="checkbox"/> <input type="text"/>	<input type="text"/>	<input type="text"/>	<input type="text"/>
<input type="text"/>	<input type="checkbox"/> <input type="text"/>	<input type="text"/>	<input type="text"/>	<input type="text"/>
<input type="text"/>	<input type="checkbox"/> <input type="text"/>	<input type="text"/>	<input type="text"/>	<input type="text"/>
<input type="text"/>	<input type="checkbox"/> <input type="text"/>	<input type="text"/>	<input type="text"/>	<input type="text"/>



Introduction & Request Tutorial

HIGH INTENSITY DRUG TRAFFICKING AREA
Office of National Drug Control Policy



(b)(7)(A), (b)(7)(C), (b)(7)(D), (b)(7)(E), (b)(7)(F)

Hemisphere FAQ's



Submitting a Request:

7E-2	7E-4 7E-1
------	------------------

b)(7)(A), (b)(7)(D), (b)(7)(E)

Hemisphere FAQ's



Preparing the Subpoena:

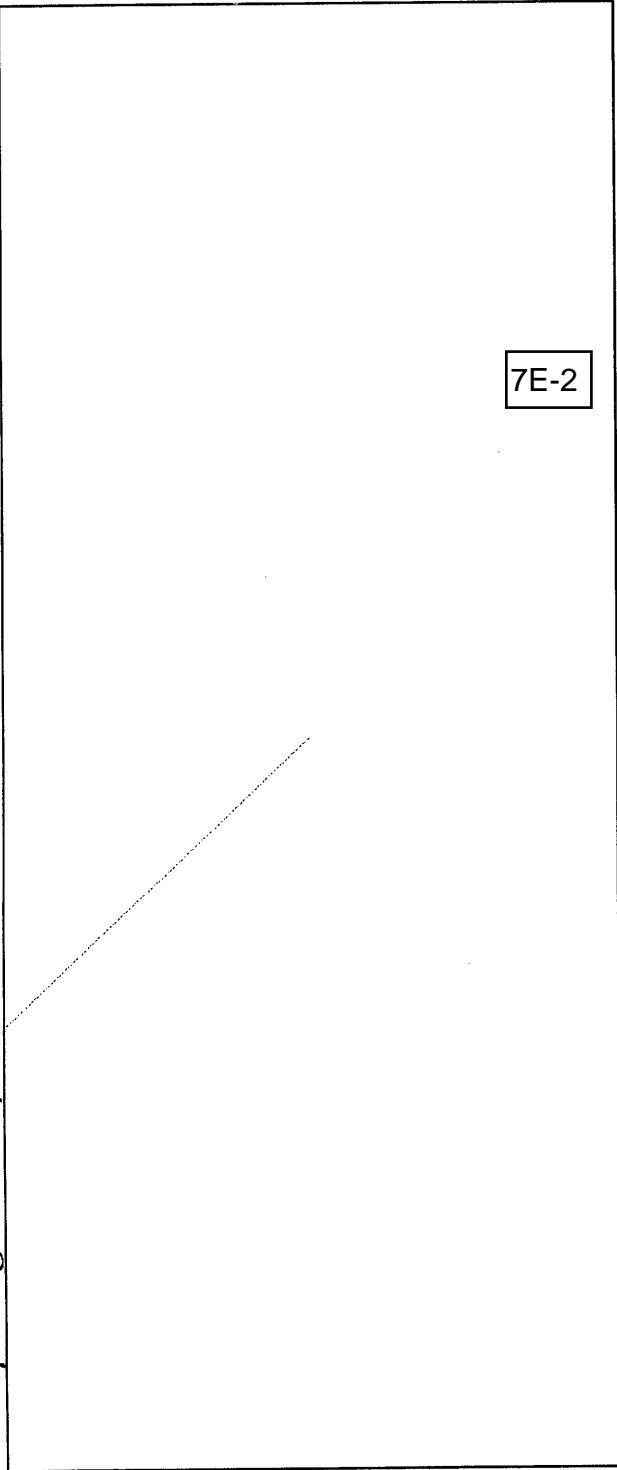

7E-2

(b)(7)(A), (b)(7)(D), (b)(7)(E)

Hemisphere FAQ's



Hemisphere Data Available to Requestors:

--	--	--	--

7E-3

7E-2

Hemisphere FAQ's



(7)(A), (b)(7)(D), (b)(7)(E)

Interpreting the Results:

7E-3

7E-7

(b)(7)(A), (b)(7)(D), (b)(7)(E)

Hemisphere FAQ's



Following Up on Requests:

7E-9

7E-4

7E-2

7E-3

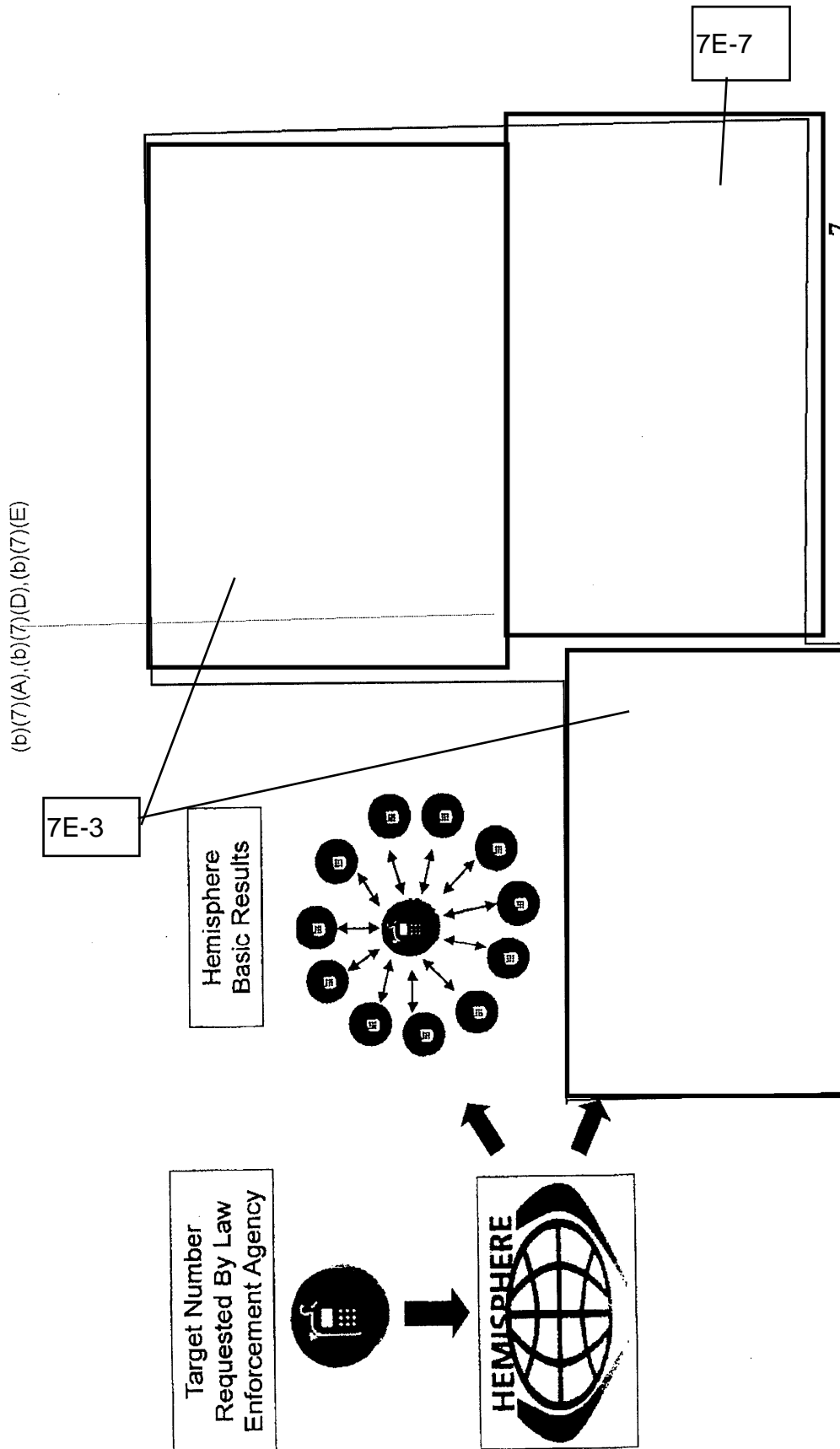

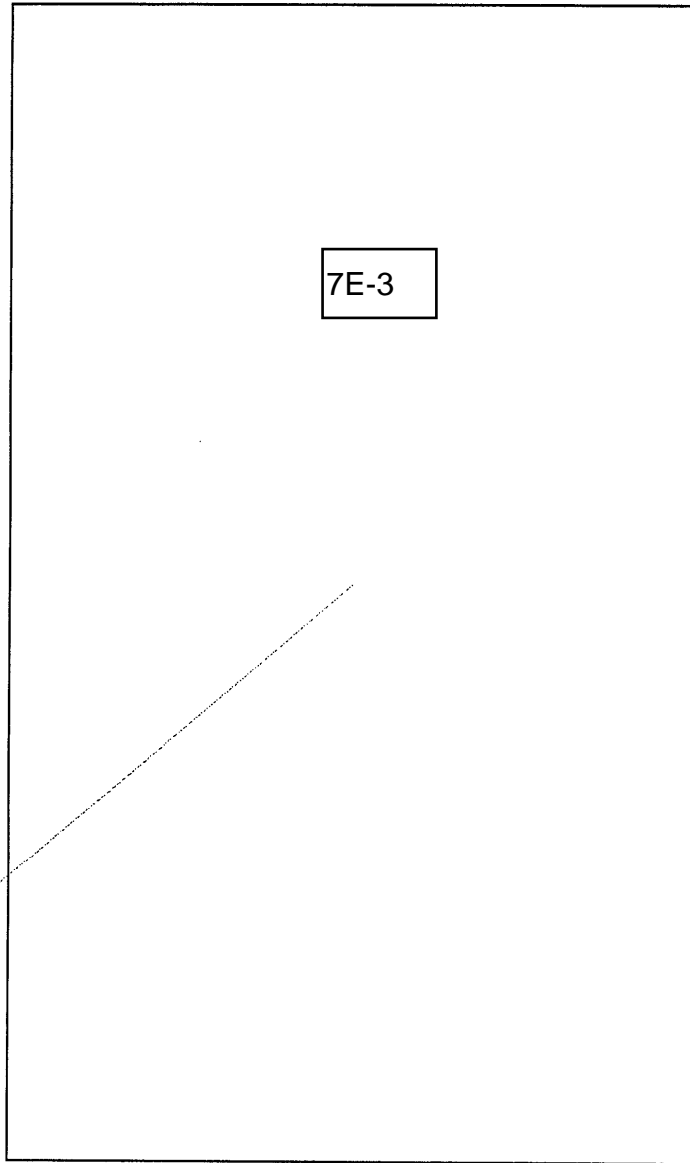

8

(b)(7)(A), (b)(7)(D), (b)(7)(E)

**Hemisphere
Basic Results**

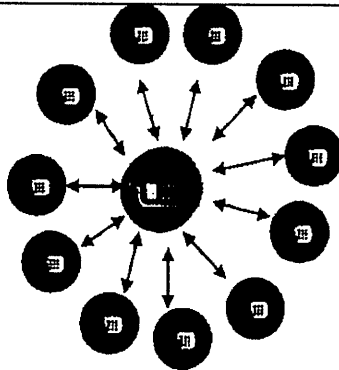

Submitting a Request

- Submitting a Request
- Hemisphere Request Process
- Hemisphere Subpoena- Official Language
- Hemisphere Subpoena- Date Ranges
- Subpoena Examples
- Court Order Example (for Los Angeles Hemisphere only)
- Hemisphere Subpoena- 7E-2
- Examples

(b)(7)(A), (b)(7)(D), (b)(7)(E)

(b)(7)(A), (b)(7)(E), (b)(7)(F)

Hemisphere Request Process



Law
Enforcement
Agencies

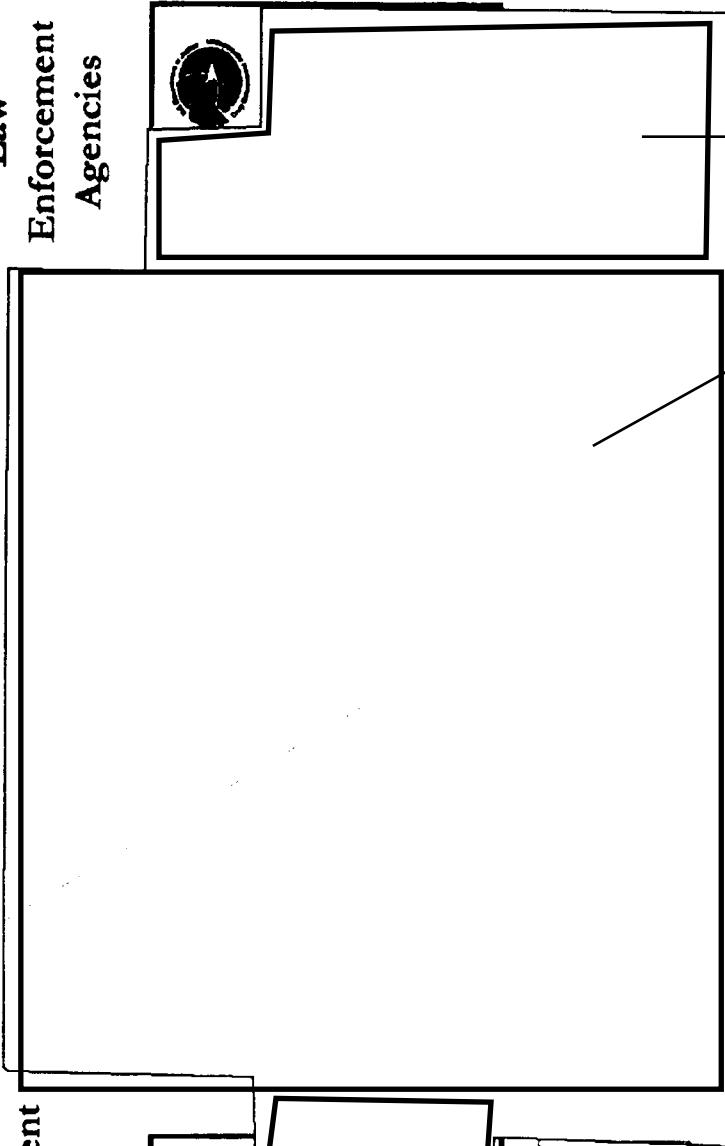

7E-5

7E-4

Law Enforcement
Agencies

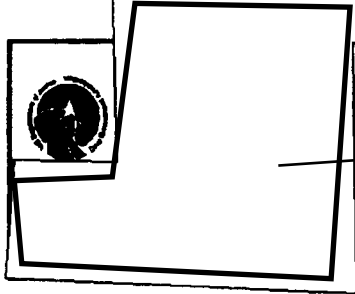

Agencies
generate
request forms
and subpoenas

7E-5

(b)(7)(A), (b)(7)(D), (b)(7)(E)



HEMISPHERE SUBPOENA- Official Language

7E-2

7E-3

b)(7)(A), (b)(7)(E)

HEMISPHERE SUBPOENA-
Official Language



**The below wording must appear on all Hemisphere
subpoenas:**

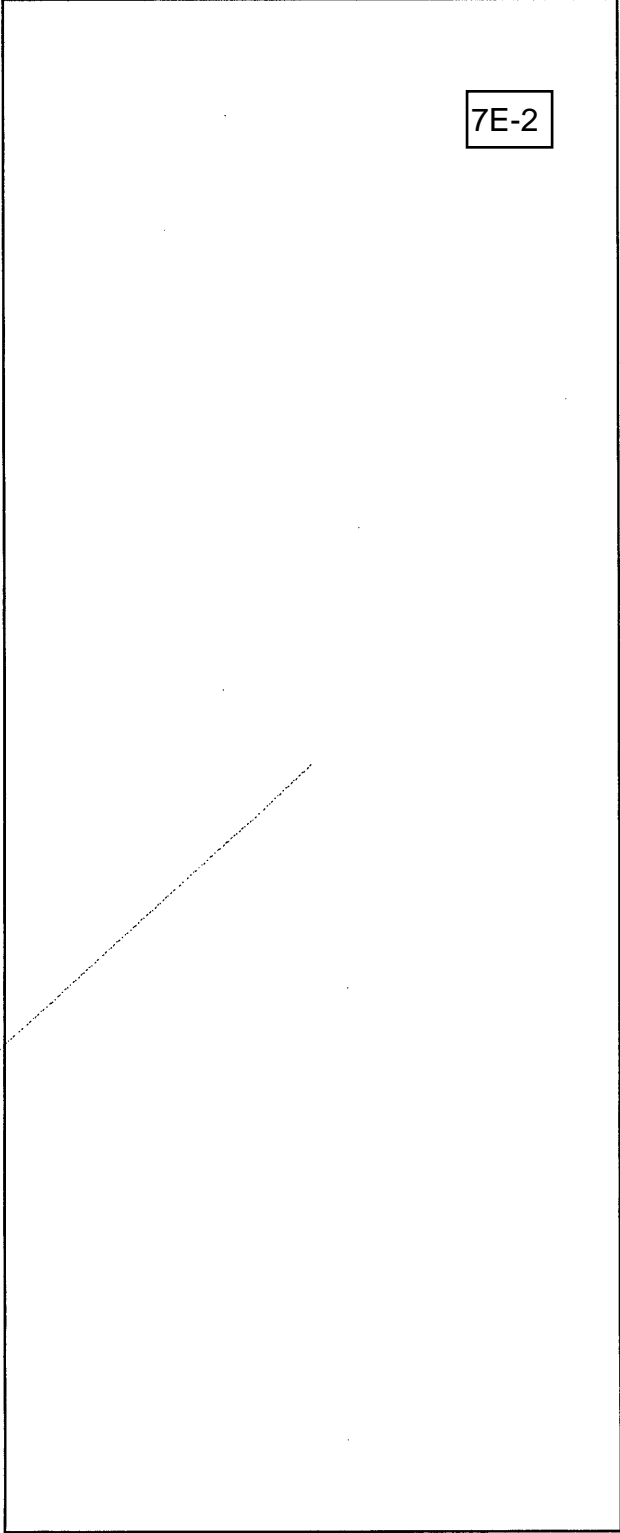

(b)(7)(A), (b)(7)(E)



HEMISPHERE SUBPOENA-

Date Ranges

7E-2

(b)(7)(A), (b)(7)(D), (b)(7)(E)

HEMISPHERE SUBPOENA-

Date Ranges



7E-2

7E-3

(b)(7)(A), (b)(7)(D), (b)(7)(E), (b)(7)(F)



HEMISPHERE SUBPOENA-

Date Ranges

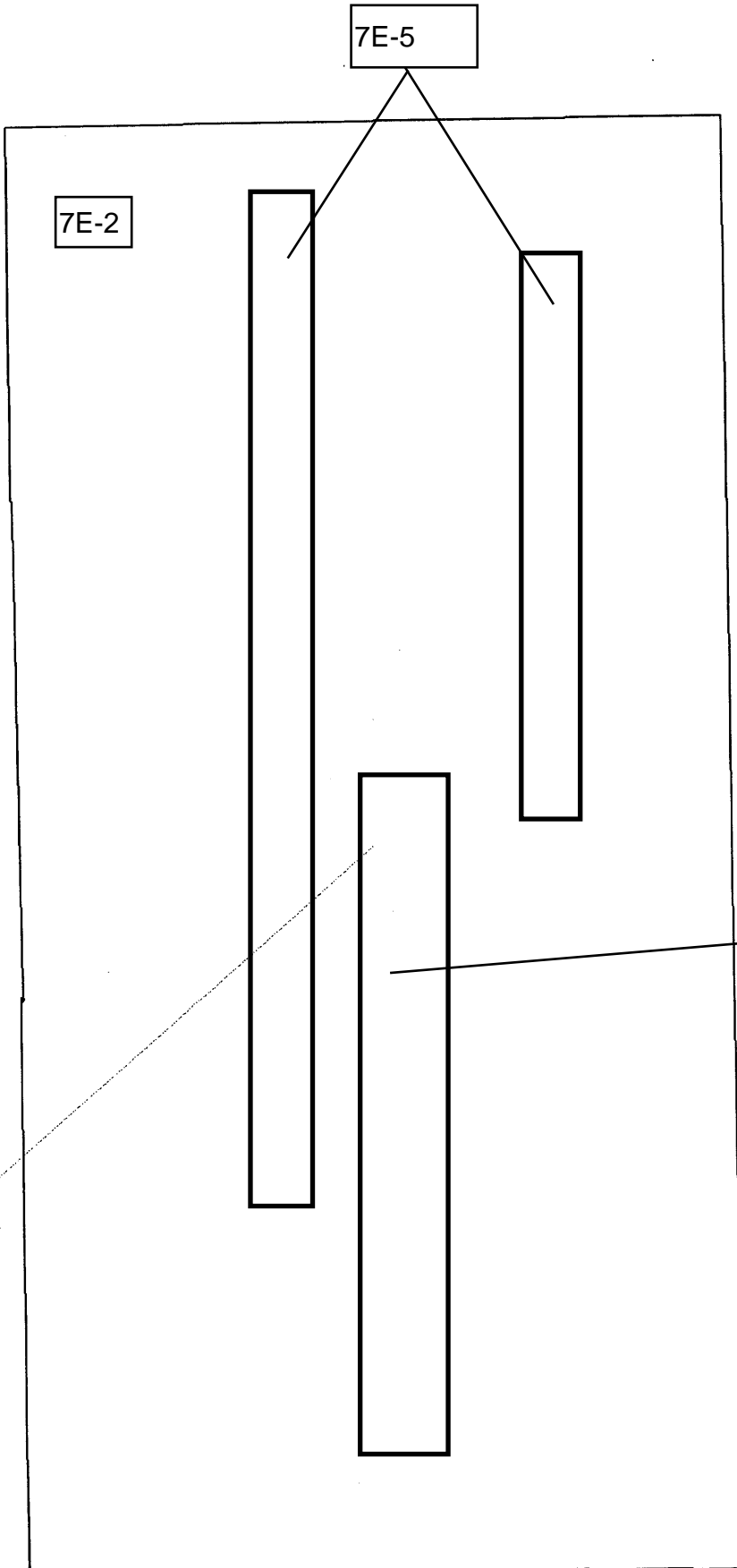

(b)(6), (b)(7)(A), (b)(7)(C), (b)(7)(D), (b)(7)(E), (b)(7)(F)

U.S. DEPARTMENT OF JUSTICE / DRUG ENFORCEMENT ADMINISTRATION

SUBPOENA

In the matter of the investigation of

[Redacted]



7E-2

7D-1, 7E-6

7E-5

6-1, 7C-1, 7E-8, 7F-1

7E-2

7D-1, 7E-6

7E-5

6), (b)(7)(A), (b)(7)(C), (b)(7)(D), (b)(7)(E), (b)(7)(F)

7E-5

7D-1, 7E-6

7E-2

7E-5

6-1, 7C-1, 7E-8, 7F-1

[Redacted]

[Redacted]

[Redacted]

[Redacted]

(b) (7)(A), (b) (7)(C), (b) (7)(D), (b) (7)(E), (b) (7)(F)

7E-2

7E-5

7E-5

7D-1, 7E-6

6-1, 7C-1, 7E-8, 7F-1

(6), (b) (7)(A), (b) (7)(C), (b) (7)(D), (b) (7)(E), (b) (7)(F)

7E-2

7E-5

7E-5

7D-1, 7E-6

(b)(7)(A), (b)(7)(C), (b)(7)(D), (b)(7)(E), (b)(7)(F)

(b)(7)(A), (b)(7)(E)

COURT ORDERS FOR CALIFORNIA SUBMISSIONS ONLY!



1
2
3
4
5
6

IN THE SUPERIOR COURT OF THE STATE OF CALIFORNIA

IN AND FOR THE COUNTY OF (insert County)

IN THE MATTER OF THE APPLICATION)
OF INVESTIGATOR (insert Name))
FOR AN ORDER AUTHORIZING)
THE RELEASE OF PHONE RECORDS)))

COURT ORDER

UNDER SEAL

[Empty rectangular box for court order content]

7E-2

(b)(7)(A), (b)(7)(D), (b)(7)(E)

COURT ORDERS FOR CALIFORNIA SUBMISSIONS ONLY!

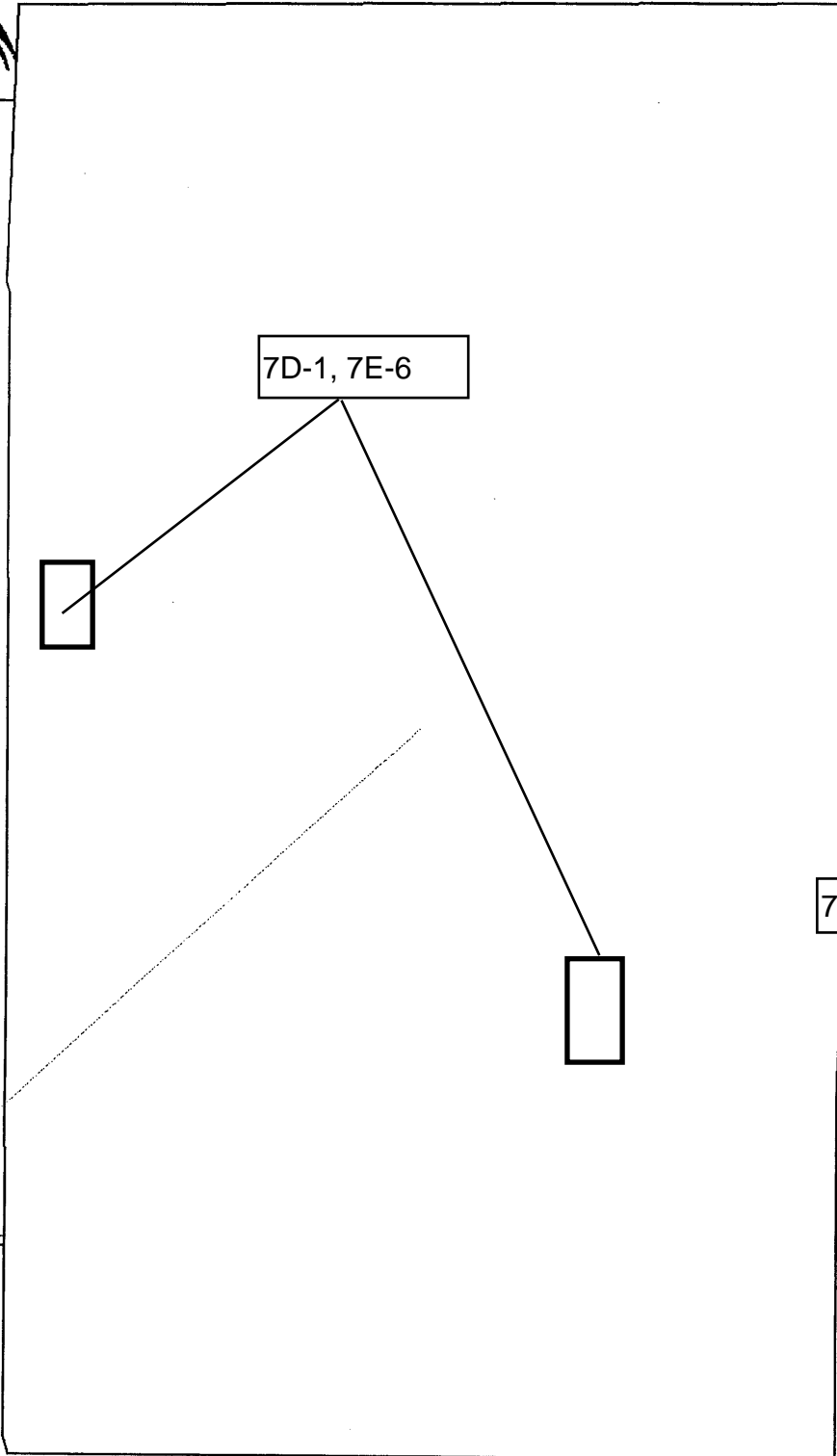

(b)(7)(A), (b)(7)(D), (b)(7)(E)

**COURT ORDERS FOR CALIFORNIA
SUBMISSIONS ONLY!**



7D-1, 7E-6

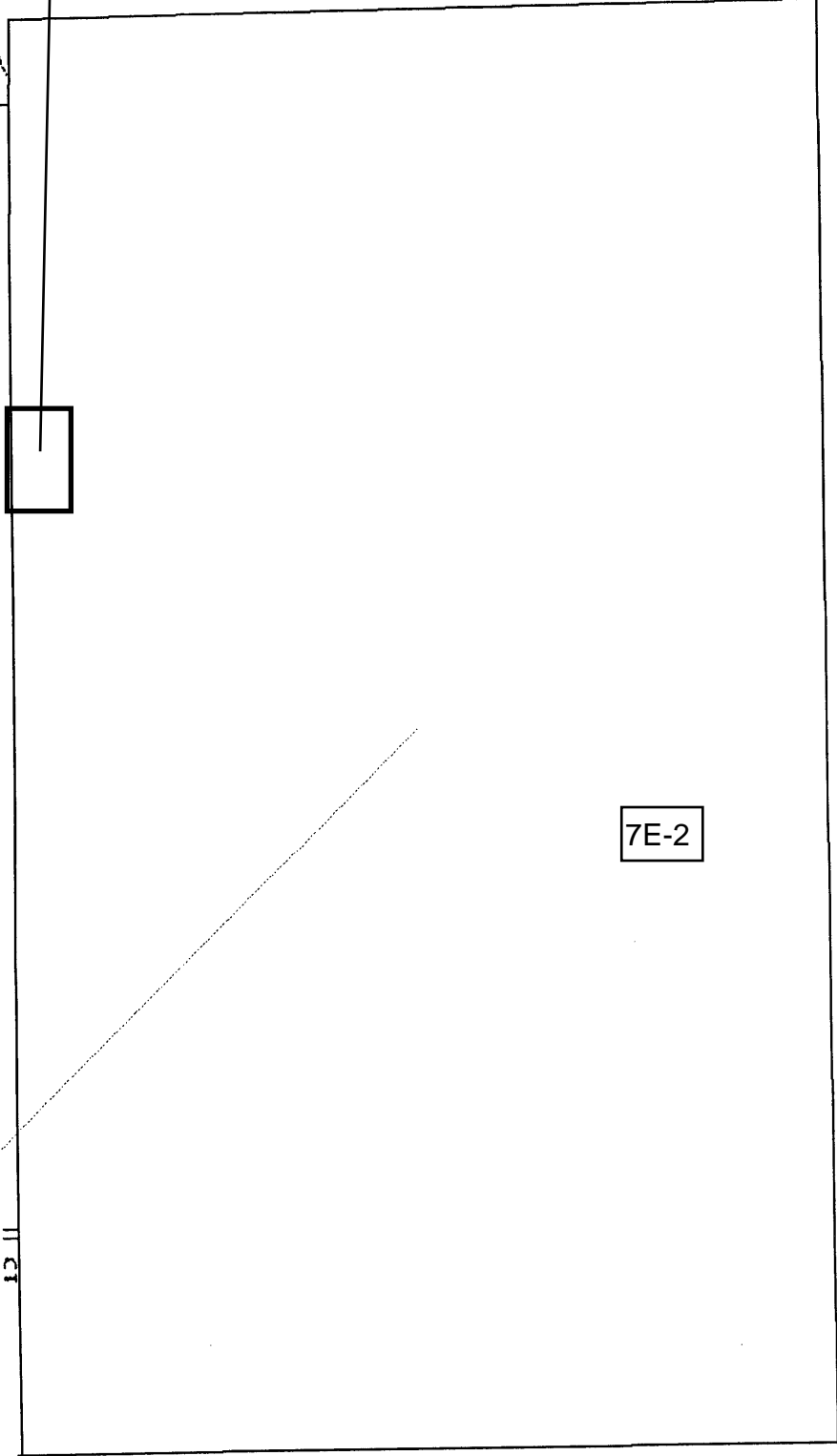

7E-2

(b)(7)(A), (b)(7)(D), (b)(7)(E)

**COURT ORDERS FOR CALIFORNIA
SUBMISSIONS ONLY!**

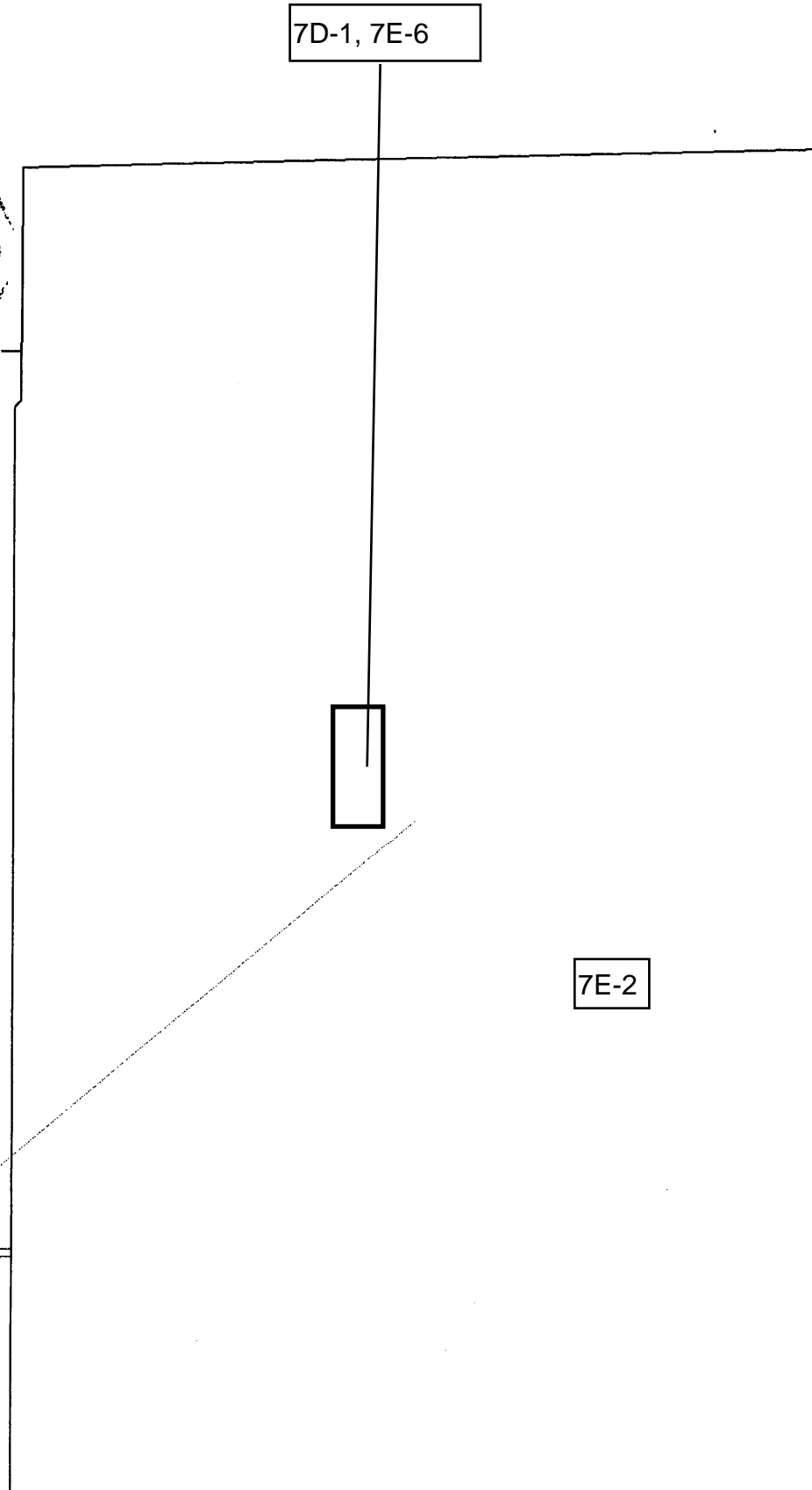

Practical Exercises



■ § 1.0 CREATING SUBPOENAS

(b)(7)(A), (b)(7)(D), (b)(7)(E)

HEMISPHERE SUBPOENA-



7E-2

7E-3

7E-4

7E-2

(7)(A), (b)(7)(E)

7E-2

(b)(7)(A), (b)(7)(E)

7E-2

) (7)(A), (b) (7)(E)

7E-2

o)(7)(A),(b)(7)(E)

7E-2

(7)(A), (b)(7)(E)

(b)(7)(A),(b)(7)(D),(b)(7)(E)

7E-2

7E-2

(7)(A), (b)(7)(D), (b)(7)(E)

(b)(7)(A), (b)(7)(D), (b)(7)(E)



HEMISPHERE REQUEST FORM-

General Instructions

- Valid email and telephone numbers are critical for the successful delivery of your request
- **Point of Contact section(s):** Must be completed on *ALL* requests
 - The Point of Contact must always be recognized as belonging to a HIDTA Intelligence Support Center
- **Requestor section(s):** Will be populated if the request is for an untrained user who is submitting through a P.O.C.

7E-2

(b)(7)(A), (b)(7)(D), (b)(7)(E)



HEMISPHERE REQUEST FORM

General Instructions

- **Priority section:** This section determines the urgency level of the request

7E-3

7E-2

7E-9

(b)(7)(A), (b)(7)(D), (b)(7)(E)



HEMISPHERE REQUEST FORM -

General Instructions

- **Priority section:** This section determines the urgency level of the request

7E-2
7E-9

s)(7)(A), (b)(7)(D), (b)(7)(E)



HEMISPHERE REQUEST FORM-

General Instructions

- **Priority section:** This section determines the urgency level of the request

7E-2

7E-9

(b)(7)(A), (b)(7)(D), (b)(7)(E)



HEMISPHERE REQUEST FORM-

Basic Requests

7E-2		7E-7	7E-3
------	--	------	------

(b)(7)(A), (b)(7)(D), (b)(7)(E)



HEMISPHERE REQUEST FORM

[Redacted content]

7E-2

7E-3



HOUSTON HIDTA
HIGH INTENSITY DRUG TRAFFICKING AREA
Office of National Drug Control Policy

Hemisphere Project Request Form

HOUSTON HIDTA

Printed Name

Please Fax When Complete

HISC Fax: (b)(7)(A), (b)(7)(E)

7E-1

Master Case Number: []

Priority: []

HIDTA Point of Contact Name: []

POC Phone Number: []

Email Notification Of Completion: []

All request forms must contain information for a HIDTA Intelligence Support Center Hemisphere Point of Contact

Requestor Name: []

Requestor Phone Number: []

Email Notification: []

"Requestor Name" and Information will only be populated if the request is for an untrained user who is submitting through a POC

DTO Name (if applicable): []

HIDTA Initiative: []

HIDTA Initiative OR Law Enforcement Agency: []

Yes No

All Hemisphere Requests must go through a HIDTA ISC POC



Please Fax When Complete

HISC Fax: (b)(7)(A), (b)(7)(E)

7E-1

Hemisphere Project Request Form

HOUSTON HIDTA



HOUSTON HIDTA
HIGH INTENSITY DRUG TRAFFICKING AREA
Office of National Drug Control Policy

Master Case Number:	Priority:	Current Date:
		2008-07-23 07:38:34
HIDTA Point of Contact Name:	Email Results To:	
POC Phone Number:	Email Notification Of Completion To:	
Requestor Name:	Email Results To:	
Requestor Phone Number:	Email Notification Of Completion To:	
DTO Name (if applicable):	Case Name (if applicable):	
HIDTA		
Yes		

Field(s) most important to ensuring that your results are returned in a timely fashion



HOUSTON HIDTA
HIGH INTENSITY DRUG TRAFFICKING AREA
Office of National Drug Control Policy

Hemisphere Project Request Form HOUSTON HIDTA

Printed Form

Please Fax When Complete

HISC Fax: (b)(7)(A), (b)(7)(E)

7E-1

Master Case Number:	Priority:	Current Date:	2008-07-23 07:38:34
HIDTA Point of Contact Name:	Email:	Phone To:	
POC Phone Number:	Email Notification:		
Requestor Name:	Email Results To:		
Requestor Phone Number:	Email Notification Of Completion To:		
<p>DTO Name (if applicable):</p> <p>Case Name (if applicable):</p>			
<p>HIDTA Initiative: <input type="checkbox"/> Yes <input type="checkbox"/> No</p> <p>HIDTA Initiative OR Law Enforcement Agency:</p> <p>Squad Name:</p> <p>Time Zone Results Requested In:</p>			

This field aids Hemisphere in assigning your request the appropriate level of action



HOUSTON HIDTA
HIGH INTENSITY DRUG TRAFFICKING AREA
Office of National Drug Control Policy

Hemisphere Project Request Form HOUSTON HIDTA

CONFIDENTIAL

Please Fax When Complete

HISC Fax: (b)(7)(A), (b)(7)(E)

7E-1

Master Case Number: [Redacted] **Priority:** [Redacted] **Current Date:** 2008-07-23 07:38:34

HIDTA Point of Contact Name: [Redacted] **Email Results To:** [Redacted]

POC Phone Number: [Redacted] **Email Notification Of Completion To:** [Redacted]

Requestor Name: [Redacted] **Email:** [Redacted]

Requestor Phone Number: [Redacted]

DTO Name (if applicable): [Redacted]

HIDTA Initiative: Yes No **HIDTA Initiative OR Law Enforcement Agency:** [Redacted]

Squad Name: [Redacted] **Time Zone Results:** [Redacted]

HIDTA: [Redacted] **NON HIDTA:** (b)(7)(C)

Indicate HIDTA/non HIDTA and what agency the request should be credited to

7E-5



HOUSTON HIDTA
HIGH INTENSITY DRUG TRAFFICKING AREA
Office of National Drug Control Policy

Hemisphère Project Request Form HOUSTON HIDTA

Please Fax When Complete

HISCFax: (b)(7)(A), (b)(7)(E)

HISMISDHFIRE



Master Case Number: Priority: Current Date: 2008-07-23 07:38:34

HIDTA Point of Contact Name: Email Results To:

POC Phone Number: Email Notification of Completion To:

Requestor Name: Email Results To:

Requestor Phone Number: Email Notification Of:

DTO Name (if applicable):

HIDTA Initiative: HIDTA Initiative OR Law Enforcement Agency:

Yes No Squad Name:

Time Zone Results Requested In:

Background / Justification / Excerpts on

Indicate what squad within your agency the request should be credited to

- HIDTA - HISC IRT
- HIDTA - HISC IS
- HIDTA - HISC IRT
- NON HIDTA - (b)(7)(A), (b)(7)(E)
- NON HIDTA - (b)(7)(A), (b)(7)(E)
- NON HIDTA - (b)(7)(A), (b)(7)(E)
- NON HIDTA - (b)(7)(A), (b)(7)(E)

7E-5

7E-2

7E-3

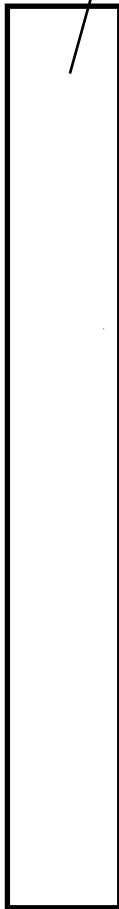

7E-5

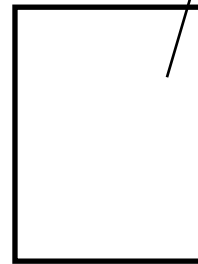

(7)(A), (b)(7)(D), (b)(7)(E)

Phone Number	Priority	Date Range								
(b)(7)(C) 7E-5		June 23, 2008	July 1, 2008							
		March 6, 2008	July 1, 2008							
		March 6, 2008	July 1, 2008							

Multiple date ranges can be requested; however this will result in requests being split

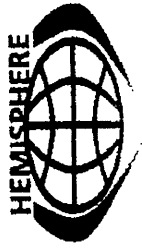

Practical Exercises

- § 2.0 COMPLETING THE REQUEST FORM

(b)(7)(A), (b)(7)(C), (b)(7)(E), (b)(7)(F)



The Next Step

7E-1

7E-2

7E-4

7E-7

This block contains a large rectangular area with a double-line border. Inside, there are several smaller rectangular boxes and lines. A box labeled "7E-1" has two lines pointing to a vertical rectangle. A box labeled "7E-2" is positioned above a box labeled "7E-4". A box labeled "7E-7" has a line pointing to the top edge of the main area.

(b)(7)(A), (b)(7)(D), (b)(7)(E)



Review- Submitting a Request

7E-2

7E-4

(b)(7)(A), (b)(7)(D), (b)(7)(E)

Hemisphere Products:

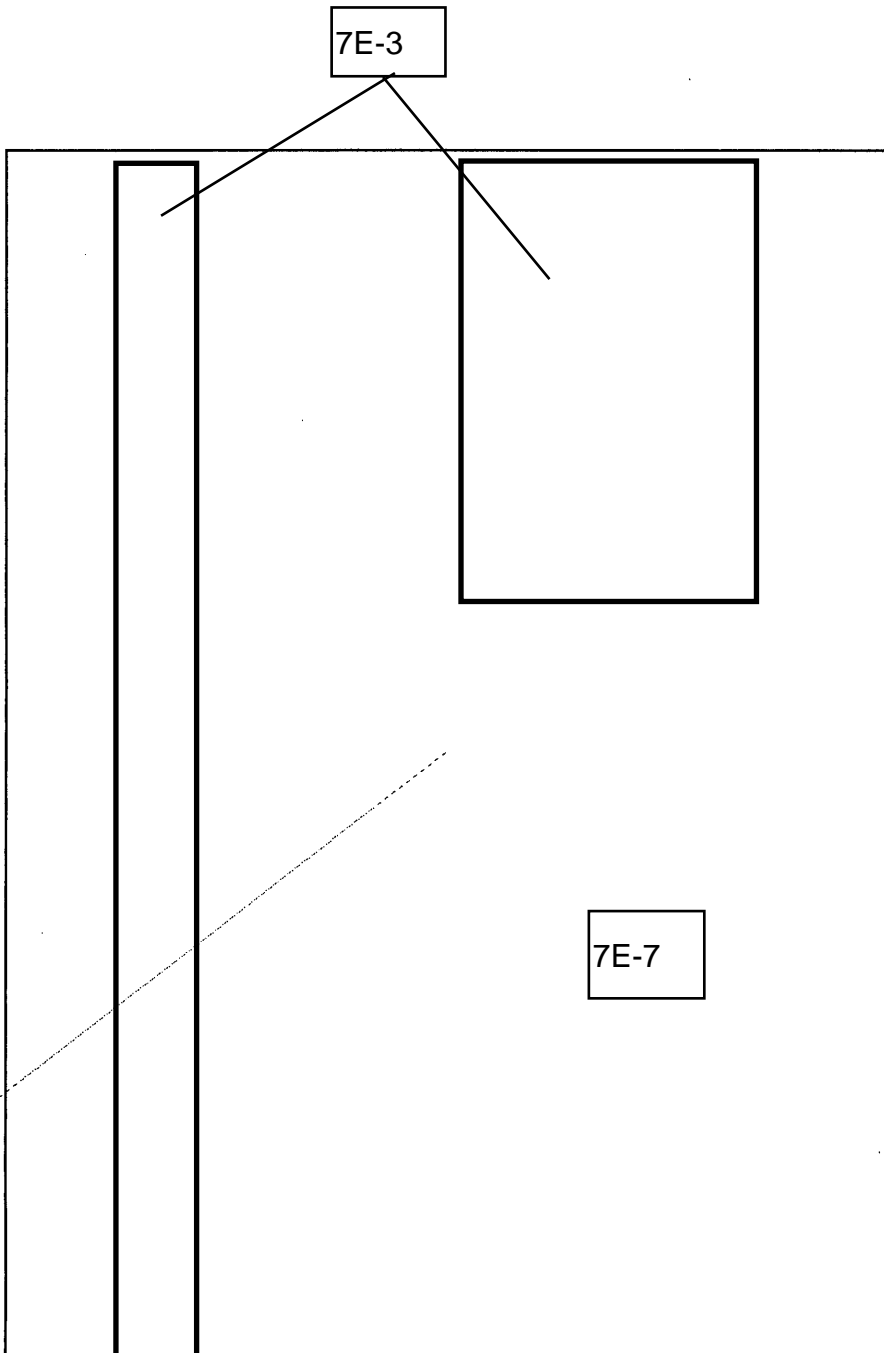



7E-3

(b)(7)(A), (b)(7)(D), (b)(7)(E)



7E-3

(b)(7)(A), (b)(7)(D), (b)(7)(E)



7E-3

(b)(7)(A), (b)(7)(D), (b)(7)(E)



7E-7

7E-2

7E-3

(b)(7)(A), (b)(7)(D), (b)(7)(E)

(b)(7)(E)

The Evolution of Hemisphere Results

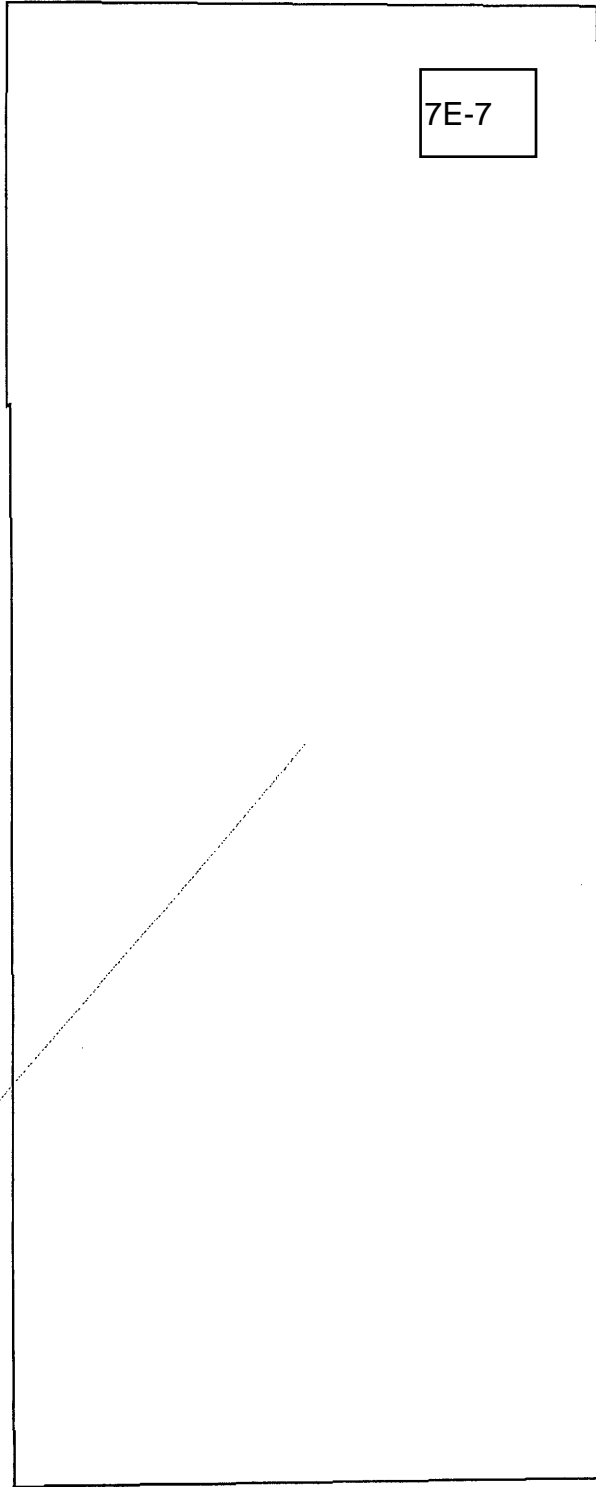

7E-7

Practical Exercises



- § 3.1 Contents of Results Email
-

(b)(7)(A);(b)(7)(E)



Understanding the

7E-7

7E-7

6-1, 7C-1, 7E-8, 7F-1



b)(6), (b)(7)(A), (b)(7)(C), (b)(7)(D), (b)(7)(E), (b)(7)(F)

7E-7

7E-3



(b)(7)(A), (b)(7)(C), (b)(7)(D), (b)(7)(E), (b)(7)(F)



Practical Exercises

- § 3.2
(b)(7)(A), (b)(7)(E)
7E-7



7E-3

7E-7

7D-1, 7E-6

Overview

(b)(7)(A), (b)(7)(D), (b)(7)(E)

7E-7

b)(7)(A), (b)(7)(C), (b)(7)(D), (b)(7)(E)



7E-3

7E-7

(b)(7)(A), (b)(7)(D), (b)(7)(E)

7E-7

b)(7)(A), (b)(7)(C), (b)(7)(D), (b)(7)(E)



7E-7

7E-3

(b)(7)(A), (b)(7)(D), (b)(7)(E)



Practical Exercises

[Redacted]

■ § 3.3

(b)(7)(E)

7E-7

7(A), (b)(7)(C), (b)(7)(D), (b)(7)(E)

7E-7

(b)(7)(A), (b)(7)(C), (b)(7)(D), (b)(7)(E)



Practical Exercises

[Redacted]

7E-7

(b)(7)(A), (b)(7)(D), (b)(7)(E) ■ § 3.4



7E-3

7E-7

(b)(7)(A), (b)(7)(D), (b)(7)(E)

7E-7

7E-3

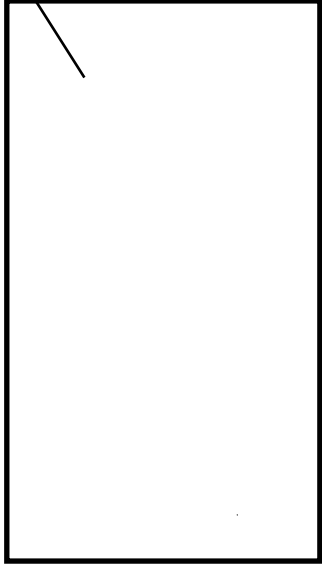
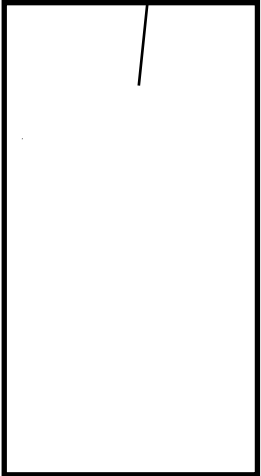
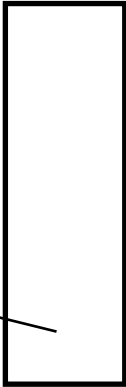

(7)(A), (b)(7)(C), (b)(7)(D), (b)(7)(E)



Practical Exercises

[Redacted]

§ 3.5

(b)(7)(A), (b)(7)(D), (b)(7)(E) ■

7E-7



7E-7

(b)(7)(A), (b)(7)(D), (b)(7)(E)

7E-7

b)(7)(A), (b)(7)(C), (b)(7)(D), (b)(7)(E)



7E-7

(b)(7)(A), (b)(7)(D), (b)(7)(E)

7E-7

b)(7)(A), (b)(7)(C), (b)(7)(D), (b)(7)(E)

Practical Exercises



[Redacted]

§ 3.6

(b)(7)(A), (b)(7)(D), (b)(7)(E)



7E-7

(b)(7)(A), (b)(7)(D), (b)(7)(E)



7E-3

7E-7

(b)(7)(A), (b)(7)(D), (b)(7)(E)

7E-7

b)(7)(A), (b)(7)(C), (b)(7)(D), (b)(7)(E)



Practical Exercises

[Redacted]

7E-3

7E-7

(b)(7)(A), (b)(7)(D), (b)(7)(E) ■ § 3.7



7E-7

7E-3

7E-2

(b)(7)(A), (b)(7)(D), (b)(7)(E)

7E-7

7E-3

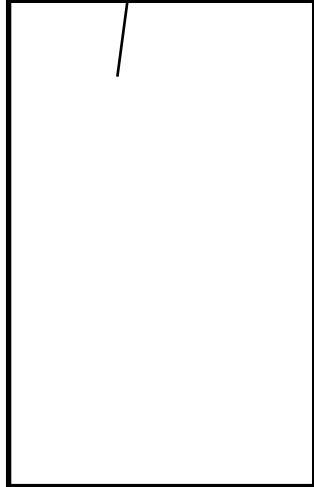

(7)(A), (b)(7)(C), (b)(7)(D), (b)(7)(E)

7E-7

(b)(7)(A), (b)(7)(C), (b)(7)(D), (b)(7)(E)



7E-3

7E-7

(b)(7)(A), (b)(7)(D), (b)(7)(E)

7E-7

7E-3

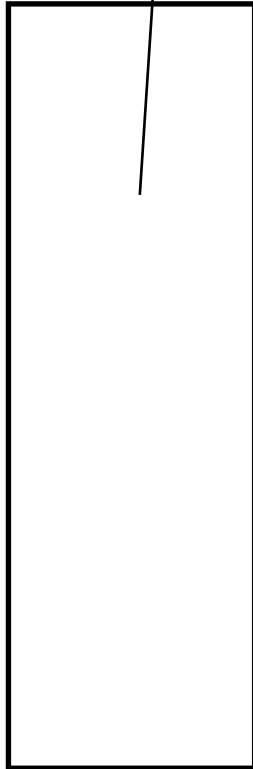

b)(7)(A), (b)(7)(C), (b)(7)(D), (b)(7)(E)



Practical Exercises

(b)(7)(A), (b)(7)(D), (b)(7)(E) ■ § 3.8

7E-3

7E-7



7E-3

7E-7

(b)(7)(A), (b)(7)(D), (b)(7)(E)

7E-7

7E-3

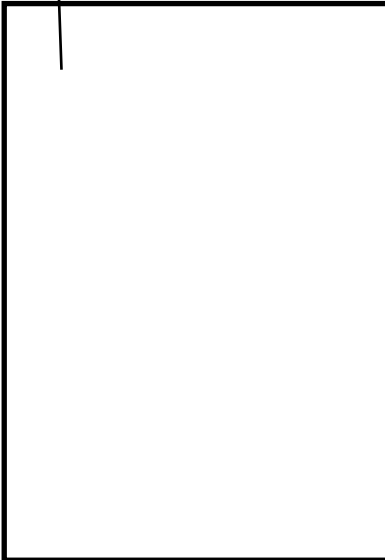
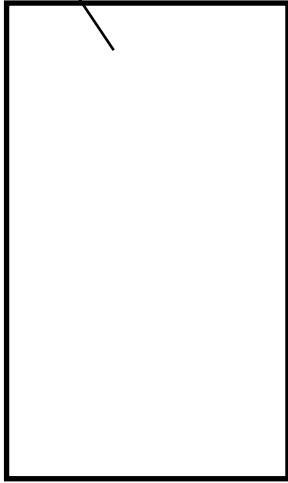
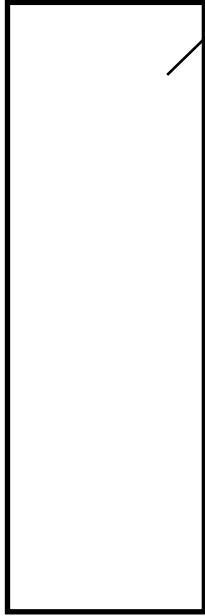

(b)(7)(A), (b)(7)(C), (b)(7)(D), (b)(7)(E)



7E-3

7E-7

(b)(7)(A), (b)(7)(D), (b)(7)(E)

7E-7

7E-3



(7)(A),(b)(7)(C),(b)(7)(D),(b)(7)(E)



Practical Exercises

[Redacted] 7E-3 [Redacted]

[Redacted] 7E-7 [Redacted]

(b)(7)(A), (b)(7)(D), (b)(7)(E) ■ § 3.9



7E-7

7E-3

(b)(7)(A), (b)(7)(D), (b)(7)(E)

7E-7

b)(7)(A), (b)(7)(C), (b)(7)(D), (b)(7)(E)

7E-7

(b)(7)(A), (b)(7)(C), (b)(7)(D), (b)(7)(E)



Practical Exercises

[REDACTED]
7E-3

7E-7

[REDACTED]

§ 3.10

(b)(7)(A), (b)(7)(D), (b)(7)(E)



7E-3

7E-7

(b)(7)(A), (b)(7)(D), (b)(7)(E)

7E-7

7E-3

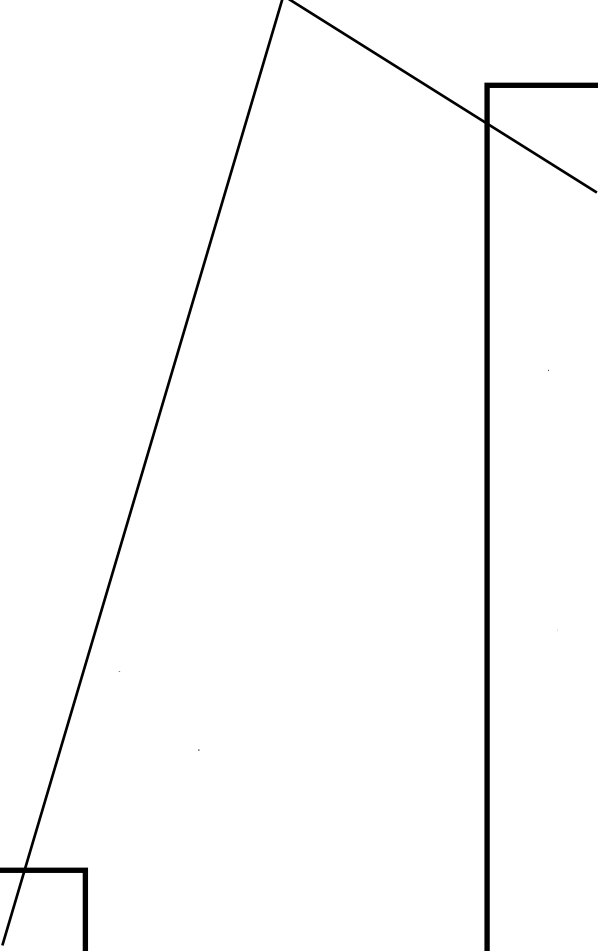
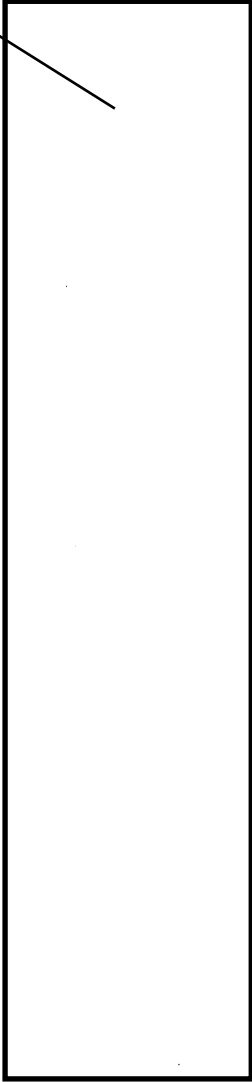
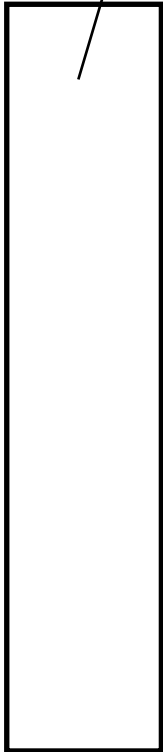

b)(7)(A), (b)(7)(C), (b)(7)(D), (b)(7)(E)



Practical Exercises

[Redacted]

b)(7)(A), (b)(7)(D), (b)(7)(E) ■

§ 4.0

7E-7

7E-3



7E-7

(b)(7)(A), (b)(7)(D), (b)(7)(E)

7E-7

(b)(7)(A), (b)(7)(C), (b)(7)(D), (b)(7)(E)



7E-7

(b) (7)(A), (b) (7)(D), (b) (7)(E)

7E-7

(7)(A), (b)(7)(C), (b)(7)(D), (b)(7)(E)

Practical Exercises



(b)(7)(A),(b)(7)(E) ■ § 5.0

[Redacted]

7E-7

(b)(7)(A), (b)(7)(D), (b)(7)(E)

Review- Hemisphere Products:



7E-7

7E-3

(b)(7)(A), (b)(7)(D), (b)(7)(E)

Hemisphere Products:

- Understanding the Results Email

7E-3

7E-7

(b)(7)(A), (b)(7)(D), (b)(7)(E)



Understanding the Results Email

7E-3

7E-7

7E-7

7E-3



(b)(6), (b)(7)(A), (b)(7)(C), (b)(7)(D), (b)(7)(E), (b)(7)(F)

(b)(7)(A), (b)(7)(D), (b)(7)(E)



Understanding the Results Email

[Redacted]

7E-7

■ Scanned Copy of Original Request

- ("HH Task... .pdf") - A scanned copy of the packet that the Hemisphere [Redacted] receive

- The packet will contain additional documents (including our [Redacted] added by [Redacted] the Hemisphere Project

[Redacted]

7E-3

7E-7

7E-4

7E-4

**Scanned Copy of the
Original Request**

A scanned copy of the packet that
The Hemisphere [redacted] receive

(includes [redacted])

(b)(6), (b)(7)(A), (b)(7)(C), (b)(7)(D), (b)(7)(E), (b)(7)(F)

7E-7

7E-7

7E-3

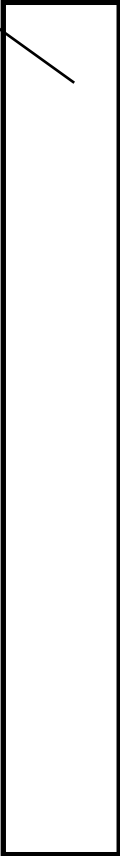
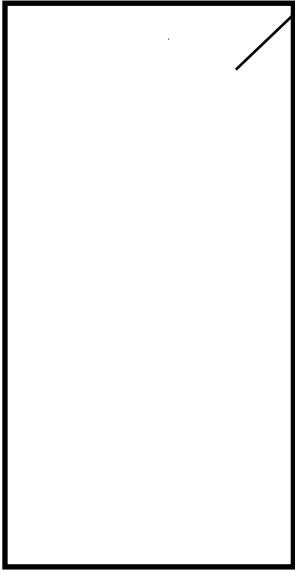

6-1, 7C-1, 7E-8, 7F-1

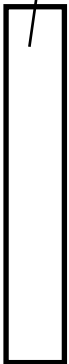

(b)(7)(A), (b)(7)(C), (b)(7)(D), (b)(7)(E), (b)(7)(F)

(b)(7)(A),(b)(7)(D),(b)(7)(E)

7E-11

7E-11

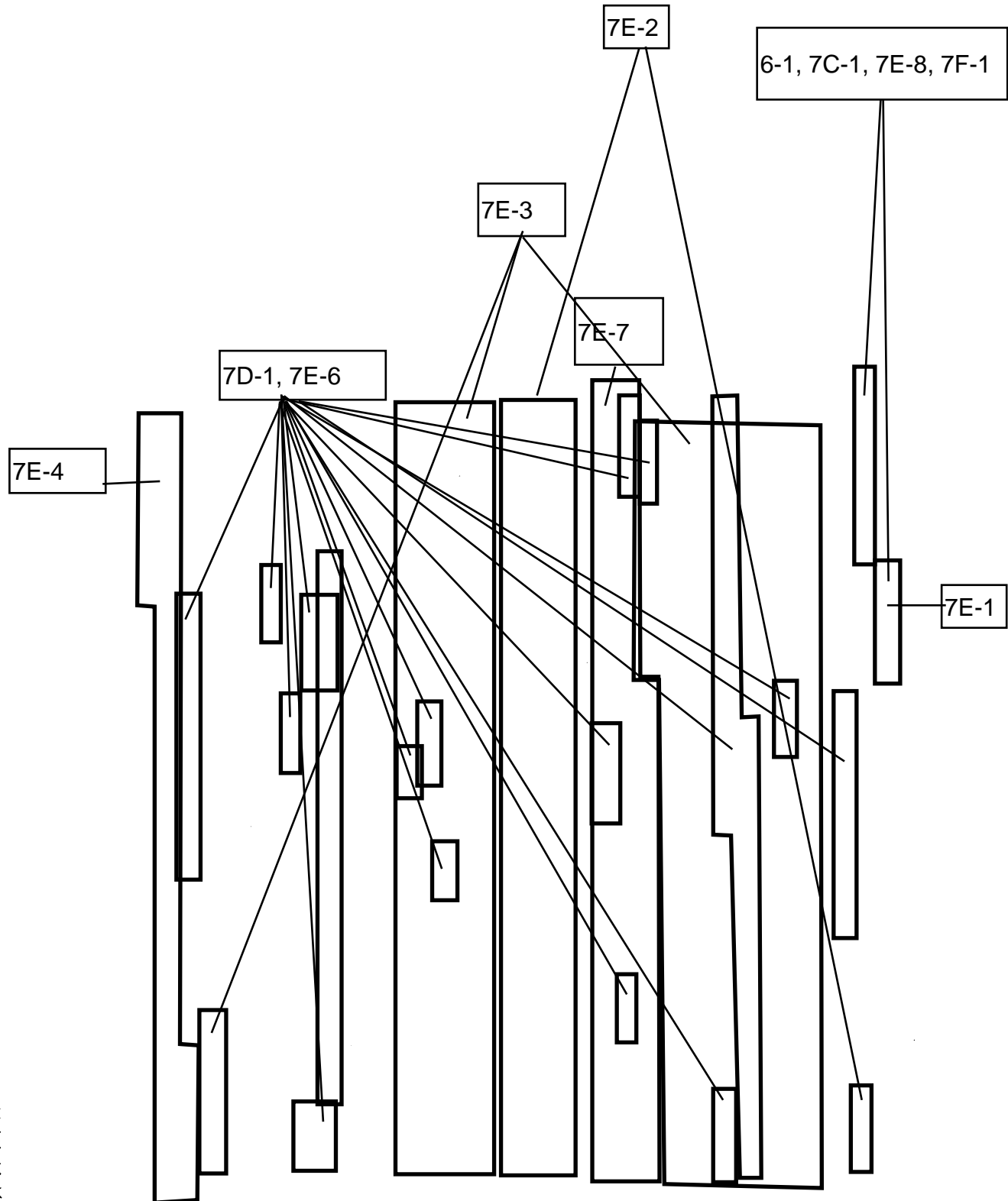

(b)(6), (b)(7)(A), (b)(7)(C), (b)(7)(D), (b)(7)(E), (b)(7)(F)



Summary Report

7E-7

(b)(7)(E)



Summary Report- Overview

7E-3

7E-7

7D-1, 7E-6

(b)(7)(A), (b)(7)(D), (b)(7)(E)

7E-7

(b)(7)(A), (b)(7)(C), (b)(7)(D), (b)(7)(E)



Report- Overview

7E-3

7E-7



(b)(7)(A), (b)(7)(D), (b)(7)(E)

7E-7

(b)(7)(A), (b)(7)(C), (b)(7)(D), (b)(7)(E)



Practical Exercises

[Redacted]
7E-7

(b)(7)(A), (b)(7)(D), (b)(7)(E) ■ § 6.0

REPORT

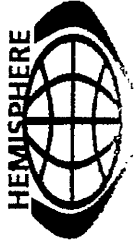

Overview

7E-3

7E-7

(b)(7)(A), (b)(7)(D), (b)(7)(E)

7E-7

7E-3

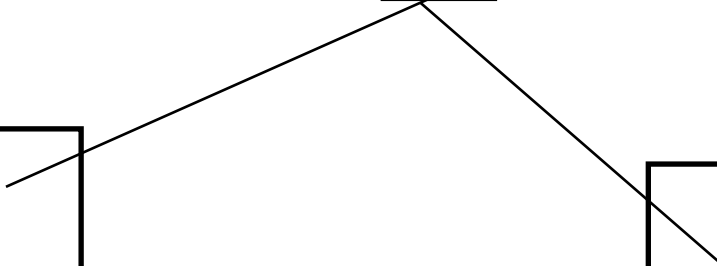
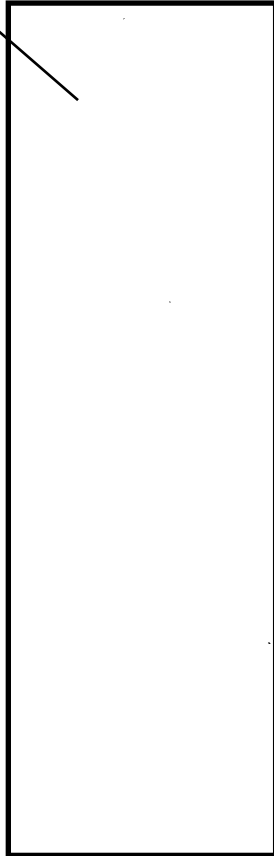

(7)(A), (b)(7)(C), (b)(7)(D), (b)(7)(E)

7E-7

7E-3

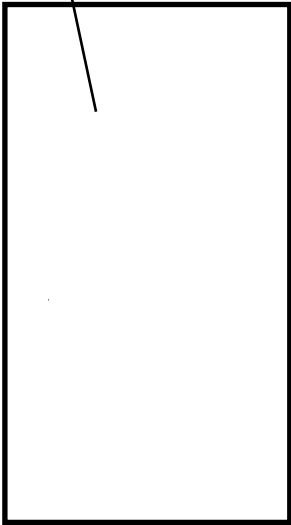

b)(7)(A), (b)(7)(C), (b)(7)(D), (b)(7)(E)



Practical Exercises

[Redacted]

7E-3

7E-7

[Redacted]

(b)(7)(A), (b)(7)(D), (b)(7)(E) ■ § 7.0



7E-7

(b)(7)(A)-(b)(7)(E)

(b)(6), (b)(7)(A), (b)(7)(C), (b)(7)(D), (b)(7)(E)

Importing Hemisphere Data



7E-7

(b)(7)(A),(b)(7)(E)

Importing Hemisphere Data



7E-7

(b)(6), (b)(7)(A), (b)(7)(C), (b)(7)(E), (b)(7)(F)

Importing Hemisphere Data



7E-7



Importing Hemisphere Data

7E-7

(b)(7)(A), (b)(7)(E)

(b)(7)(A), (b)(7)(E)

Importing Hemisphere Data



7E-7

(b)(6), (b)(7)(A), (b)(7)(C), (b)(7)(D), (b)(7)(E), (b)(7)(F)

Importing Hemisphere Data



7E-7

6-1, 7C-1, 7E-8, 7F-1

(b)(7)(A), (b)(7)(E)



Importing Hemisphere Data

7E-7

(b)(7)(A);(b)(7)(E)

Importing Hemisphere Data



7E-7

(b)(7)(A);(b)(7)(E)

Importing Hemisphere Data



7E-7

(b)(7)(A); (b)(7)(E)

Importing Hemisphere Data

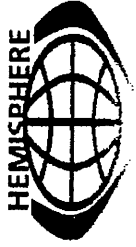

7E-7

(b)(7)(A), (b)(7)(D), (b)(7)(E)



Review-Hemisphere Products:

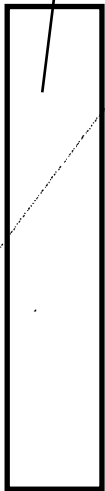

7E-3

7E-7

Practical Exercises



■ § 8.0 CUMULATIVE REVIEW

(b)(7)(A), (b)(7)(D), (b)(7)(E)

Hemisphere Products:

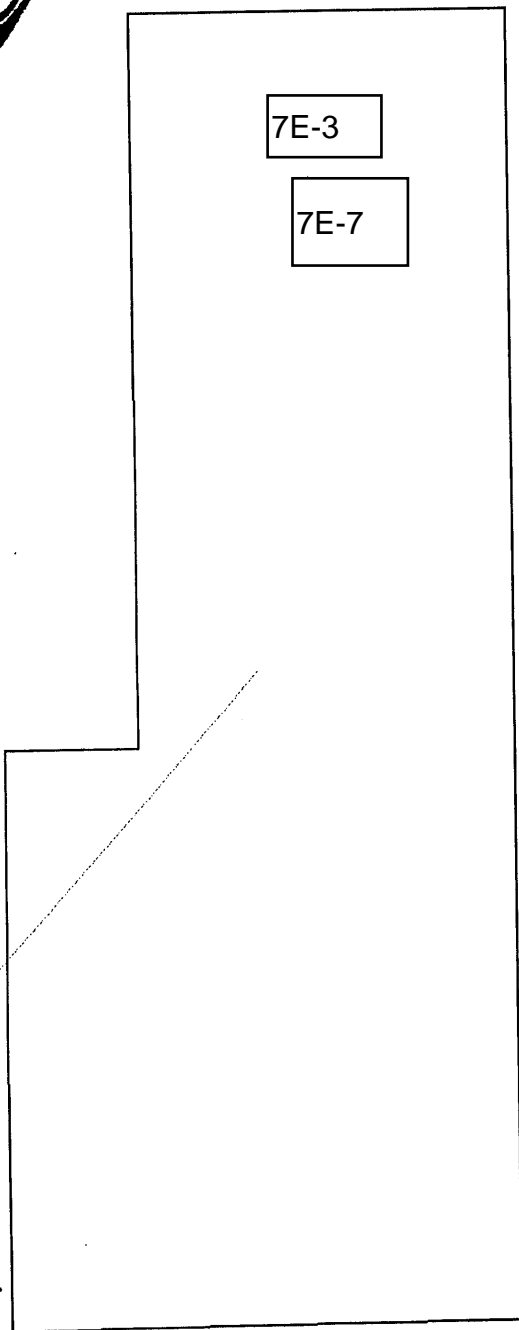

7E-3

7E-7



Searching For

7E-3

7E-7

(b)(7)(A), (b)(7)(D), (b)(7)(E)

7E-3

7E-7

(b)(7)(A), (b)(7)(C), (b)(7)(D), (b)(7)(E), (b)(7)(F)

7E-3

7E-7

b)(6), (b)(7)(A), (b)(7)(C), (b)(7)(D), (b)(7)(E), (b)(7)(F)

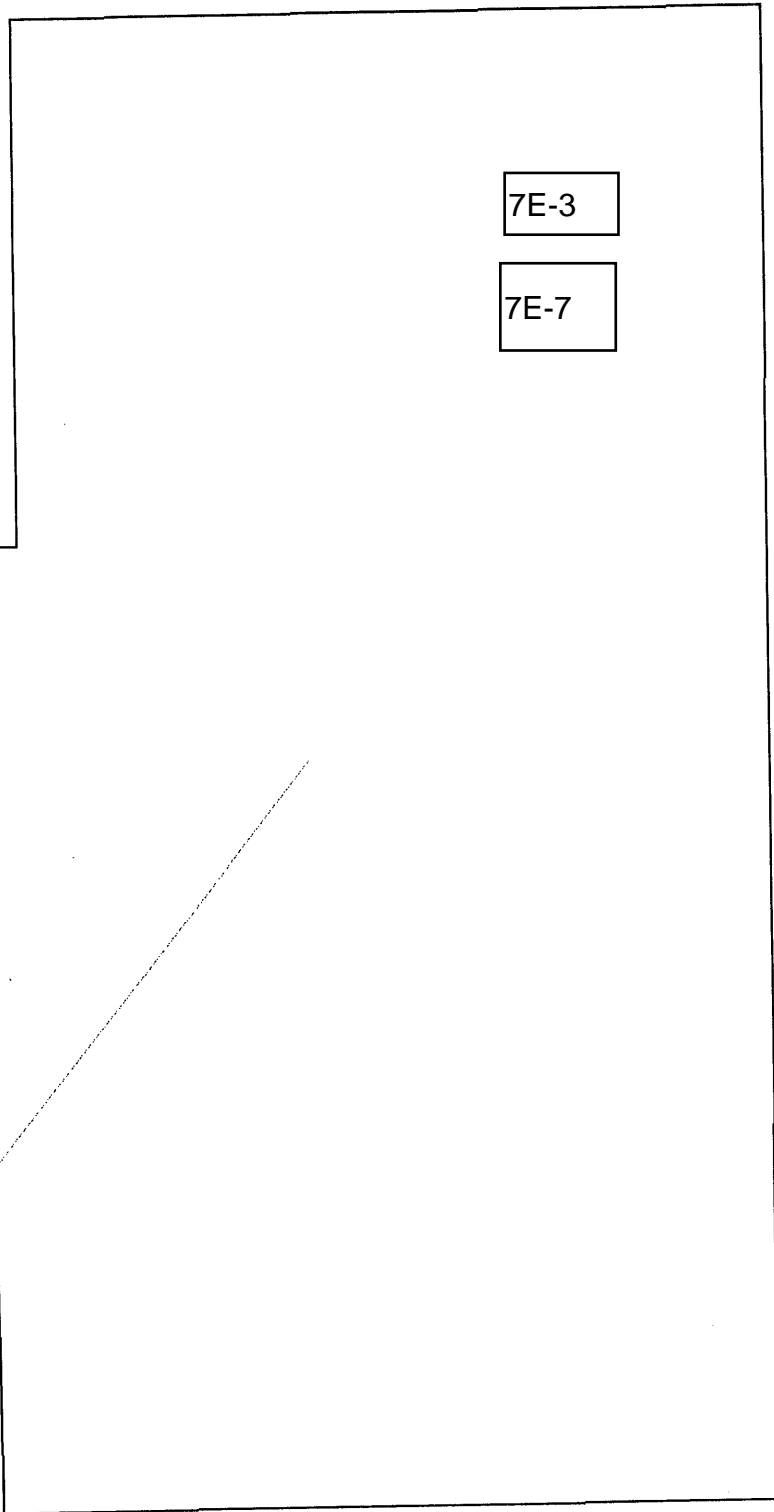

7E-3

7E-7

Hemisphere

(b)(7)(A), (b)(7)(D), (b)(7)(E)

Hemisphere

6-1, 7C-1, 7E-8, 7F-1



7E-3

7E-7

(b)(7)(A), (b)(7)(C), (b)(7)(D), (b)(7)(E), (b)(7)(F)

Questions?



Questions?
**Please contact your Hemisphere HIDTA
ISC P.O.C.**

Or, for assistance regarding:

- The identification of your appropriate P.O.C.*
- P.O.C. contact information*
- The arrangement of training sessions*
- General Hemisphere questions*

call the Houston Hemisphere Training Team at

[Redacted]

(b)(7)(C)

7E-1

Non
Responsive

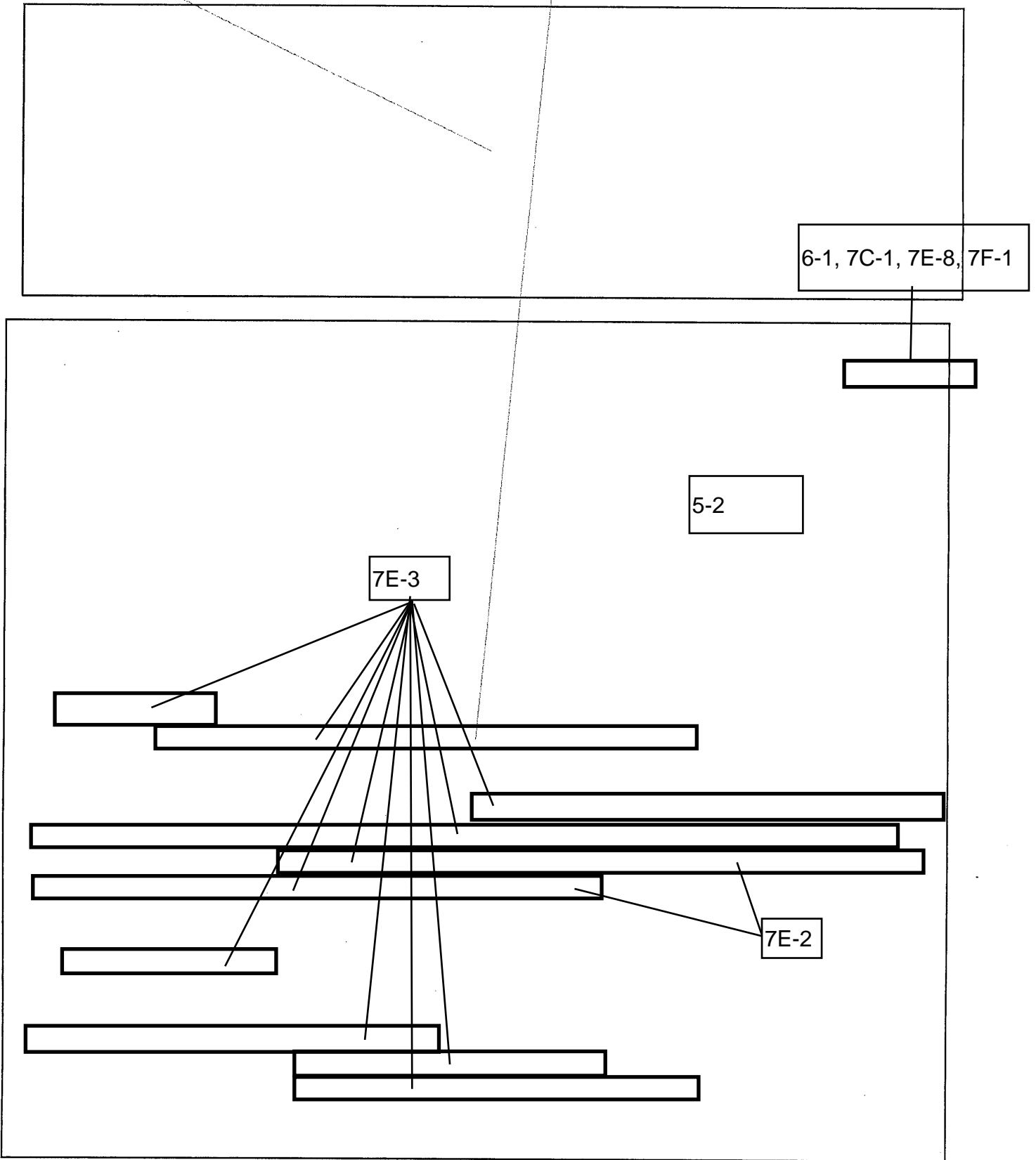

(b)(5),(b)(6),(b)(7)(A),(b)(7)(C),(b)(7)(D),(b)(7)(E)

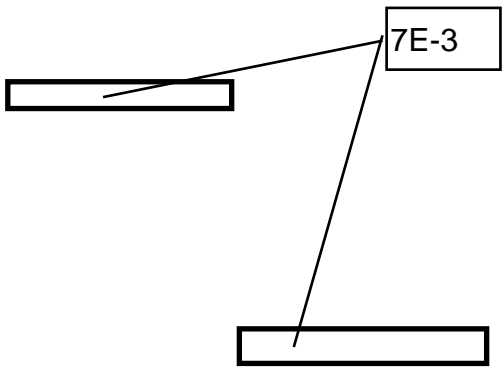

5-2



Hemisphere Project Request Form

7E-1

(b)(7)(C),(b)(7)(E)

LOS ANGELES HIDTA

Please Fax When Complete
LACLEAR Hemisphere Fax: []

Type of Request []

Master Case Number: [] Other Case Number: [] Date: []

Drug Type Associated with Investigation: [] Priority: []

HIDTA Point of Contact Name: [] Email Results To: []

POC Phone Number: [] Email Notification Of Completion To: []

Requestor Name: [] Email Results To: []

Requestor Phone Number: [] Email Notification Of Completion To: []

Drug Trafficking Organization/Name (if applicable) []

Case Name (if applicable): []

HIDTA Initiative? Yes No

HIDTA Initiative OR Law Enforcement Agency: []

(b)(7)(E)

Squad Name: []

Time Zone Results Requested in: []

7E-2

Page 2 HEMISPHERE REQUEST

Phone Number

Date Range Requested

Phone Number	Date Range Requested
	To
	To
	To
	To
	To
	To
	To
	To
	To
	To
	To
	To
	To
	To
	To
	To
	To
	To
	To
	To
	To
	To



Hemisphere Project Request Form

7E-1 7E-2 7E-9

Print Form

Please Fax When Complete

NACLEAR Hemisphere Fax: (b)(7)(C),(b)(7)(E)

Questions? Phone: (b)(7)(E) Type of Request: Basic

Master Case Number: [Redacted] Other Case Number: [Redacted] Date: [Redacted]

Drug Type Associated with Investigation: Narcotic Related Priority: [Redacted]

Submitting Investigator/Analyst: [Redacted] Secure Phone Number: [Redacted]

Lead Case Investigator if Different from Above: [Redacted]

Lead Case Investigator Phone Number: [Redacted]

E-mail Results To: [Redacted] E-mail Notification of Completion To: [Redacted]

Drug Trafficking Organization/Name (if applicable): [Redacted]

Case Name (if applicable): [Redacted]

HIDTA Initiative? Yes No HIDTA Initiative OR Law Enforcement Agency: [Redacted]

Squad Name: [Redacted]

(b)(7)(E) Time Zone Results Requested in: Pacific Standard Time (PST -8)

7E-2

Page 2 HEMISPHERE REQUEST

Phone Number

Date Range Phone Was Active

Phone Number	Date Range Phone Was Active
	To
	To
	To
	To
	To
	To
	To
	To
	To
	To
	To
	To
	To
	To
	To
	To
	To
	To
	To
	To
	To
	To
	To