



U.S. Department of Justice
Drug Enforcement Administration
FOI/Records Management Section
8701 Morrissette Drive
Springfield, Virginia 22152

JUL 21 2014

Case Number: 14-00009-F

Subject: INFORMATION PERTAINING TO THE HEMISPHERE PROGRAM

Bruce Friedrich
Electronic Privacy Information Center
1718 Connecticut Ave NW
Suite 200
Washington, DC 20009

Dear Mr. Friedrich:

This letter responds to your Freedom of Information/Privacy Act (FOI/PA) request dated September 25, 2013, addressed to the Drug Enforcement Administration (DEA), Freedom of Information/Privacy Act Unit (SARF), seeking access to information regarding the above subject.

The processing of your request identified certain materials that will be released to you. Portions not released are being withheld pursuant to the Freedom of Information Act, 5 U.S.C. § 552, and/or the Privacy Act, 5 U.S.C. § 552a. Please refer to the list enclosed with this letter that identifies the authority for withholding the deleted material, which is indicated by a mark appearing in the block next to the exemption. An additional enclosure with this letter explains these exemptions in more detail. The documents are being forwarded to you with this letter.

The rules and regulations of the Drug Enforcement Administration applicable to Freedom of Information Act requests are contained in the Code of Federal Regulations, Title 28, Part 16, as amended. They are published in the Federal Register and are available for inspection by members of the public.

For your information, Congress excluded three discrete categories of law enforcement and national security records from the requirements of the FOIA. See 5 U.S.C. § 552(c) (2006 & Supp. IV 2010). This response is limited to those records that are subject to the requirements of the FOIA. This is a standard notification that is given to all our requesters and should not be taken as an indication that excluded records do, or do not, exist.

Case Number: 14-00009-F

Page 2

If you are not satisfied with the response to this request, you may administratively appeal by writing to the Director, Office of Information Policy, United States Department of Justice, Suite 11050, 1425 New York Avenue, NW, Washington, DC 20530-0001, or you may submit an appeal through OIP's eFOIA portal at <http://www.justice.gov/oip/efoia-portal.html>. Your appeal must be received within sixty (60) days from the date of this letter. If you submit your appeal by mail, both the letter and the envelope should be clearly marked "Freedom of Information Act Appeal."

If you have any questions regarding this letter, you may contact Government Information Specialist J. Delo on 202-307-7748.

Sincerely,

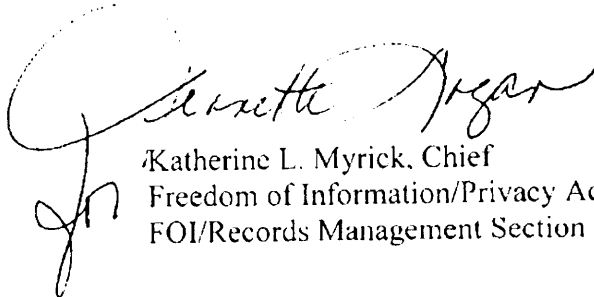

Katherine L. Myrick, Chief
Freedom of Information/Privacy Act Unit
FOI/Records Management Section

Enclosures

Number of pages withheld: 103

Number of pages released: 216

APPLICABLE SECTIONS OF THE FREEDOM OF INFORMATION AND/OR PRIVACY ACT:

**Freedom of Information Act
5 U.S.C. 552**

**Privacy Act
5 U.S.C. 552a**

- (b)(1) (b)(5) (b)(7)(C)
- (b)(2) (b)(6) (b)(7)(D)
- (b)(3) (b)(7)(A) (b)(7)(E)
- (b)(4) (b)(7)(B) (b)(7)(F)

- (d)(5) (k)(2)
- (j)(2) (k)(5)
- (k)(1) (k)(6)

FREEDOM OF INFORMATION ACT
SUBSECTIONS OF TITLE 5, UNITED STATES CODE, SECTION 552

- (b)(1) Information which is currently and properly classified pursuant to Executive Order in the interest of the national defense or foreign policy.
- (b)(2) Materials related solely to the internal rules and practices of DEA.
- (b)(3) Information specifically exempted from disclosure by another federal statute.
- (b)(4) Privileged or confidential information obtained from a person, usually involving commercial or financial matters.
- (b)(5) Inter-agency or intra-agency documents which are subject to a privilege, such as documents the disclosure of which would have an inhibitive effect upon the development of policy and administrative direction, or which represent the work product of an attorney, or which reflect confidential communications between a client and an attorney.
- (b)(6) Materials contained in sensitive records such as personnel or medical files, the disclosure of which would constitute a clearly unwarranted invasion of personal privacy.
- (b)(7) Records or information compiled for law enforcement purposes, but only to the extent that the production of such law enforcement records or information (A) could reasonably be expected to interfere with enforcement proceedings; (B) would deprive a person of a right to a fair trial or an impartial adjudication; (C) could reasonably be expected to constitute an unwarranted invasion of personal privacy; (D) could reasonably be expected to disclose the identity of a confidential source, including a State, local or foreign agency or authority or any private institution which furnished information on a confidential basis; and, in the case of a record or information compiled by a criminal law enforcement authority in the course of a criminal investigation, or by an agency conducting a lawful national security intelligence investigation, information furnished by a confidential source; (E) would disclose techniques and procedures for law enforcement investigations or prosecutions or would disclose guidelines for law enforcement investigations or prosecutions if such disclosure could reasonably be expected to risk circumvention of the law, or (F) could reasonably be expected to endanger the life or physical safety of any individual.

PRIVACY ACT
SUBSECTIONS OF TITLE 5, UNITED STATES CODE, SECTION 552a

- (d)(5) Materials compiled in reasonable anticipation of a civil action or proceeding.
- (j)(2) Material reporting investigative efforts pertaining to the enforcement of criminal law including efforts to prevent, control, or reduce crime or apprehend criminals.
- (k)(1) Information which is currently and properly classified pursuant to Executive Order in the interest of the national defense or foreign policy.
- (k)(2) Material compiled during civil investigations for law enforcement purposes.
- (k)(5) Investigatory material compiled solely for the purpose of determining suitability, eligibility, or qualifications for Federal civilian employment or for access to classified information, the disclosure of which would reveal the identity of the person who furnished information pursuant to an express promise that his identity would be held in confidence, or pursuant to an implied promise of confidentiality if such information was furnished prior to September 27, 1975.
- (k)(6) The substance of tests used to determine individual qualifications for appointment or promotion in Federal Government Service.



Hemisphere Project Request Form

Please Fax When Complete

7E-1

HRC Fax : (b)(7)(A),(b)(7)(E)

HIGH INTENSITY DRUG TRAFFICKING AREA
Office of National Drug Control Policy

WASHINGTON/BALTIMORE HIDTA

Master Case Number:	<input type="text"/>	Priority:	<input type="text"/>	Current Date:	2014-05-29 10:48:48
HIDTA Point of Contact Name:		Email Results To:			
<input type="text"/>		<input type="text"/>			
POC Phone Number:		Email Notification Of Completion To:			
<input type="text"/>		<input type="text"/>			
Requestor Name:		Email Results To:			
<input type="text"/>		<input type="text"/>			
Requestor Phone Number:		Email Notification Of Completion To:			
<input type="text"/>		<input type="text"/>			
DTO Name (if applicable):			Case Name (if applicable):		
<input type="text"/>			<input type="text"/>		
HIDTA Initiative:	HIDTA Initiative OR Law Enforcement Agency:				
Yes <input type="checkbox"/> No <input type="checkbox"/>	<input type="text"/>				
Squad Name:		<input type="text"/>			
Time Zone Results Requested In:		<input type="text"/>			

(b)(7)(A),(b)(7)(E)

7E-2

Phone Number

Priority

Date Range

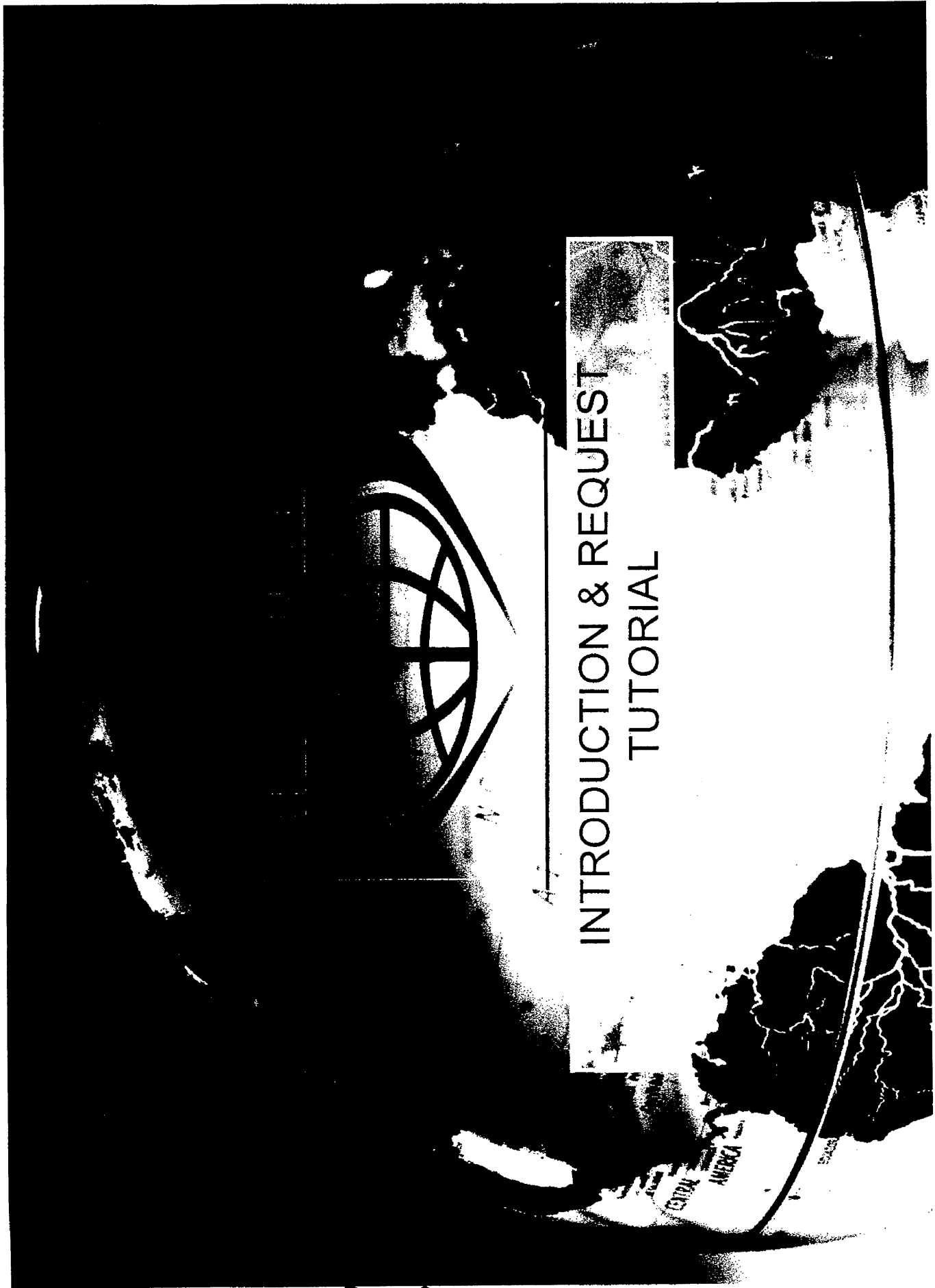

(b)(7)(A), (b)(7)(D), (b)(7)(E)

[What is Hemisphere?]

- The Hemisphere Project is a *law enforcement sensitive* subpoena compliance program funded by HIDTA/ONDSCP

[Redacted]	[Redacted]	[Redacted]
------------	------------	------------

7E-3

7E-4

7E-2

7E-4

(b)(7)(A), (b)(7)(E), (b)(7)(F)

[REDACTED] Process

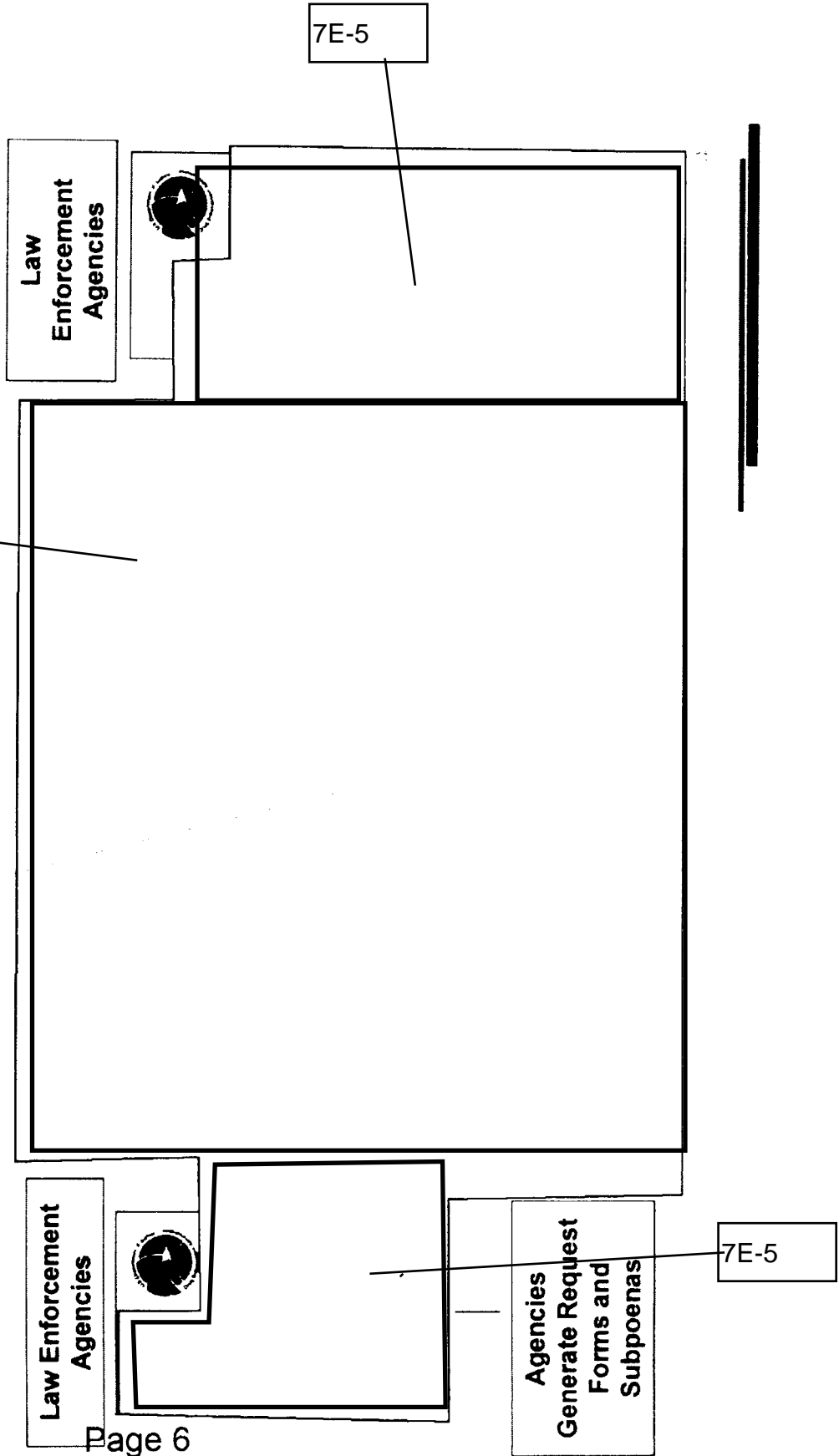

]

7D-1, 7E-6

Hemisphere

(b)(7)(A), (b)(7)
(D), (b)(7)(E)

[

7E-3

7E-4

]

What is Hemisphere?

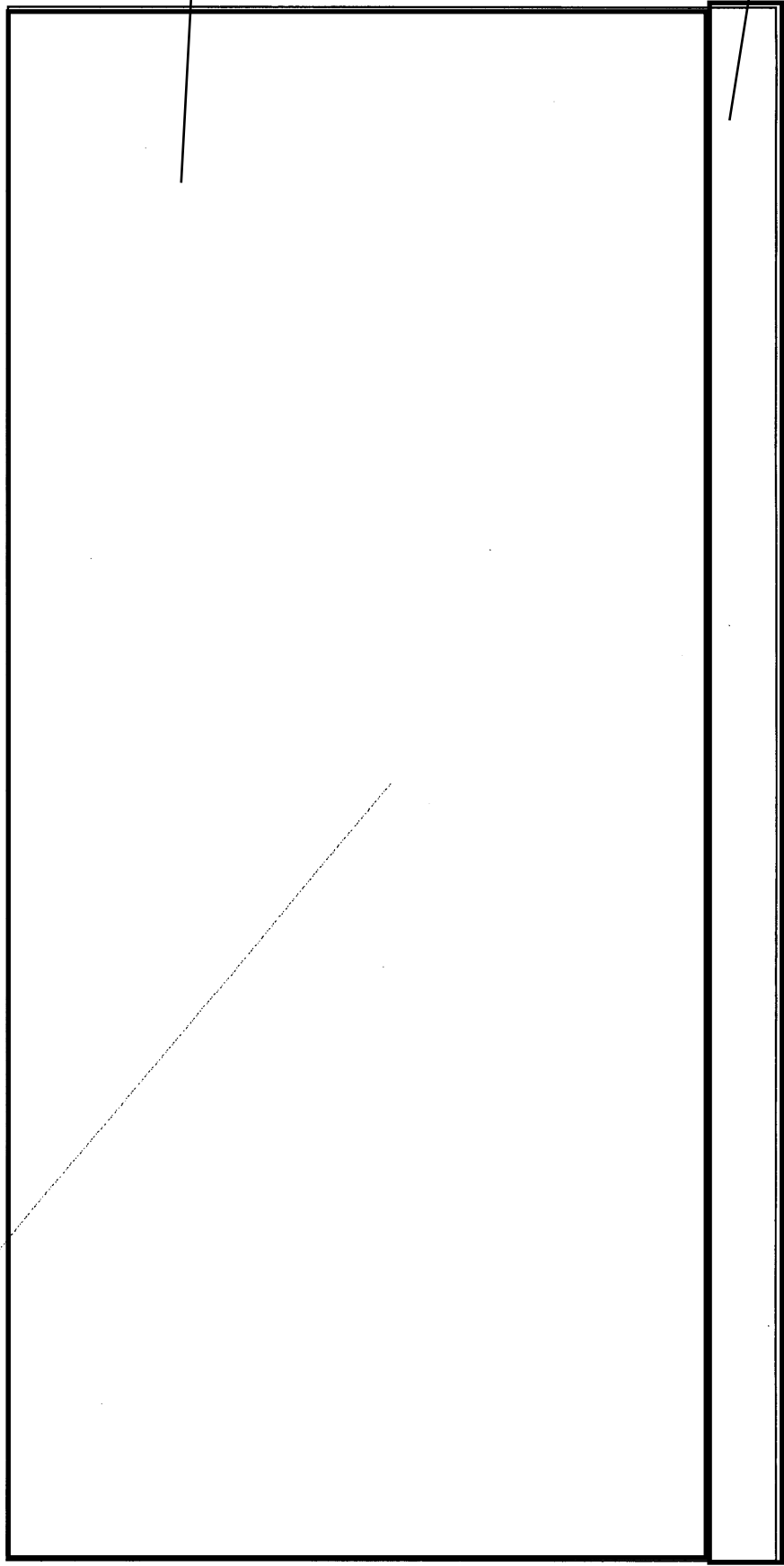

6

(b)(7)(A), (b)(7)(D), (b)(7)(E)

(b)(7)(A), (b)(7)(D), (b)(7)(E)

HEMISPHERE REQUEST FORM-



Hemisphere

include:

7E-4

7E-3

7E-2

7

7E-5



Hemisphere

(b)(7)(A), (b)(7)(D), (b)(7)(E)

7E-3

7E-7

∞

7E-4

]

Hemisphere

(b)(7)(A), (b)(7)(D), (b)(7)(E)

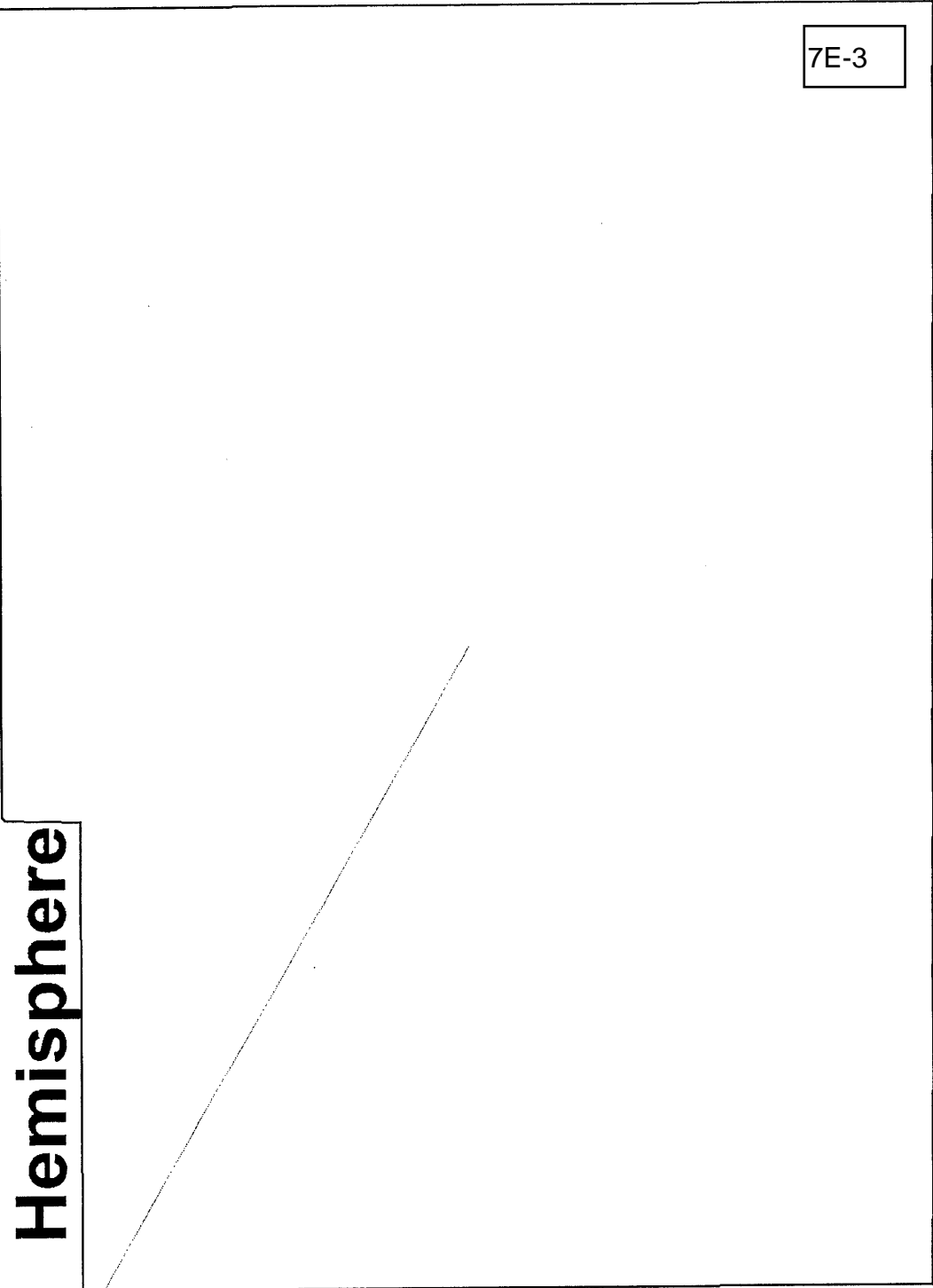

7E-3

[

[Submitting your Request]

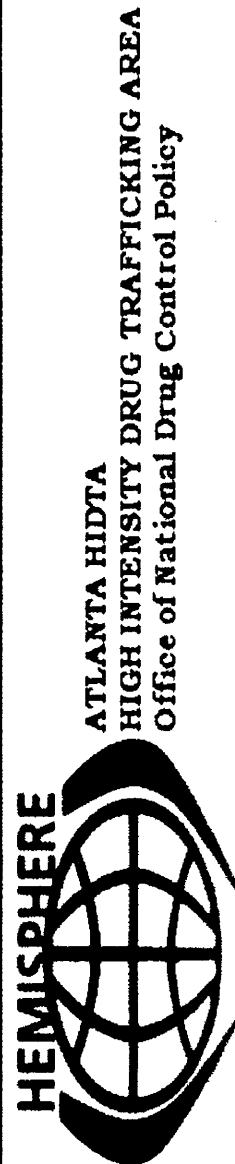

[Submitting your Request]

(b)(7)(A), (b)(7)(E)

[Redacted content]

7E-4

All Hemisphere requesters . . .

- Must protect the HEMISPHERE Program

HEMISPHERE

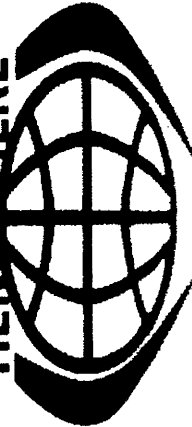

**ATLANTA HIDTA
HIGH INTENSITY DRUG TRAFFICKING AREA
Office of National Drug Control Policy**

(b)(6), (b)(7)(C), (b)(7)(F)

ATLANTA HEMISPHERE POC'S

]

6-1, 7C-1, 7E-8, 7F-1

7E-1

]

[Subpoenas

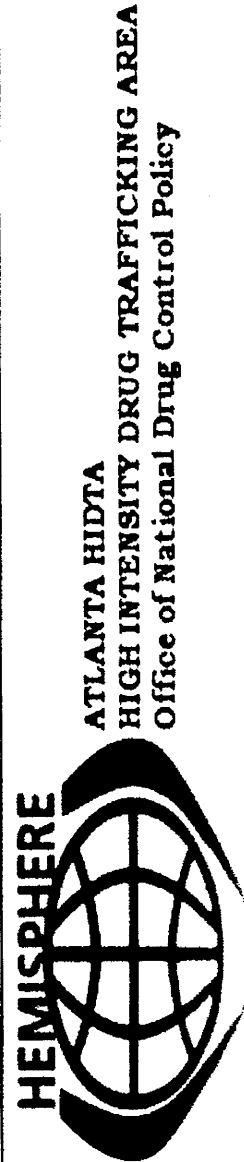

(b)(6), (b)(7)(A), (b)(7)(C), (b)(7)(D), (b)(7)(E), (b)(7)(F)

HEMISPHERE Subpoena

Language

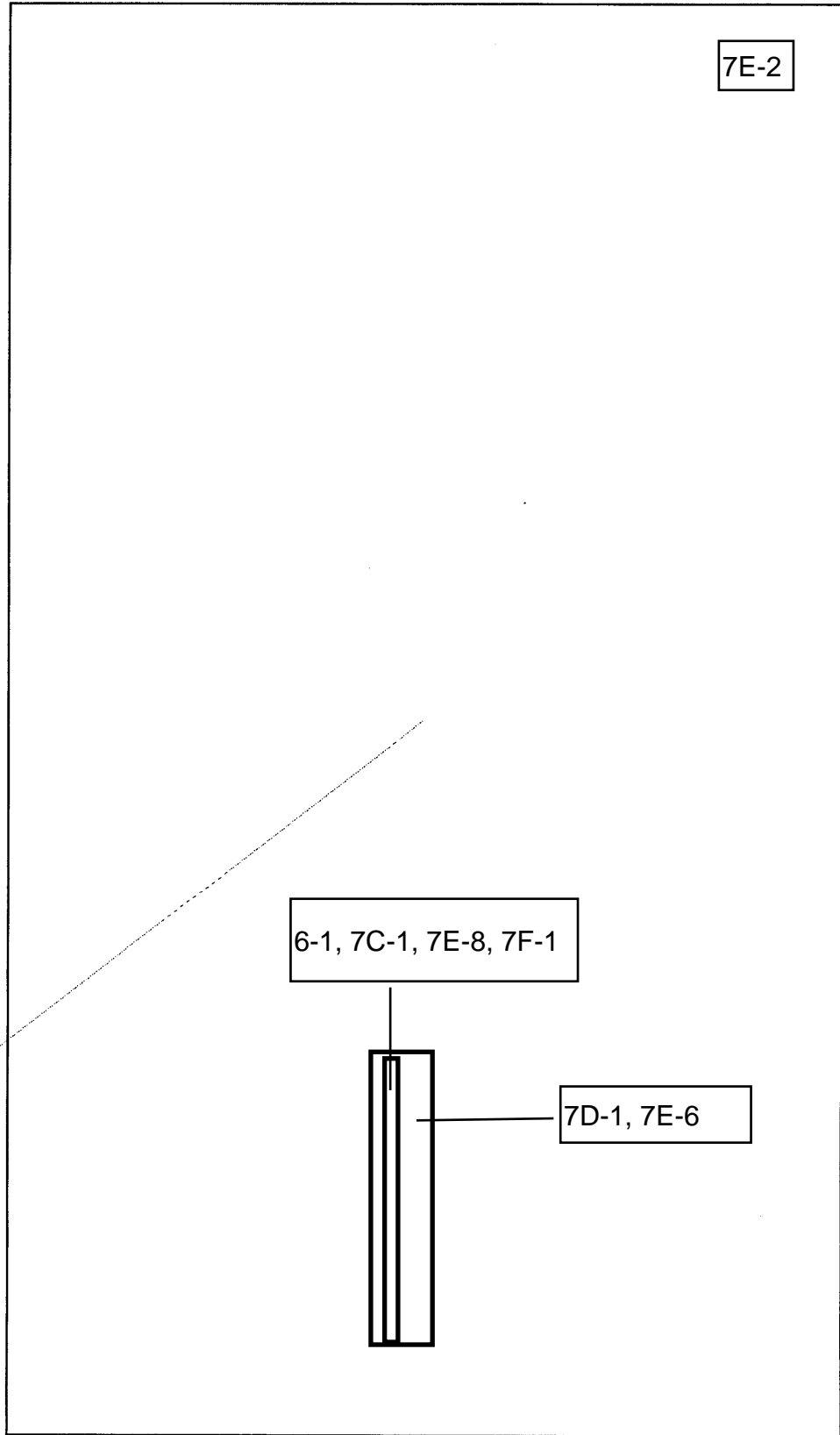

14

(b)(7)(A), (b)(7)(D), (b)(7)(E), (b)(7)(F)

[HEMISPHERE Subpoena Recipient]

**All Hemisphere subpoenas should have the following
in the recipient/address section...**

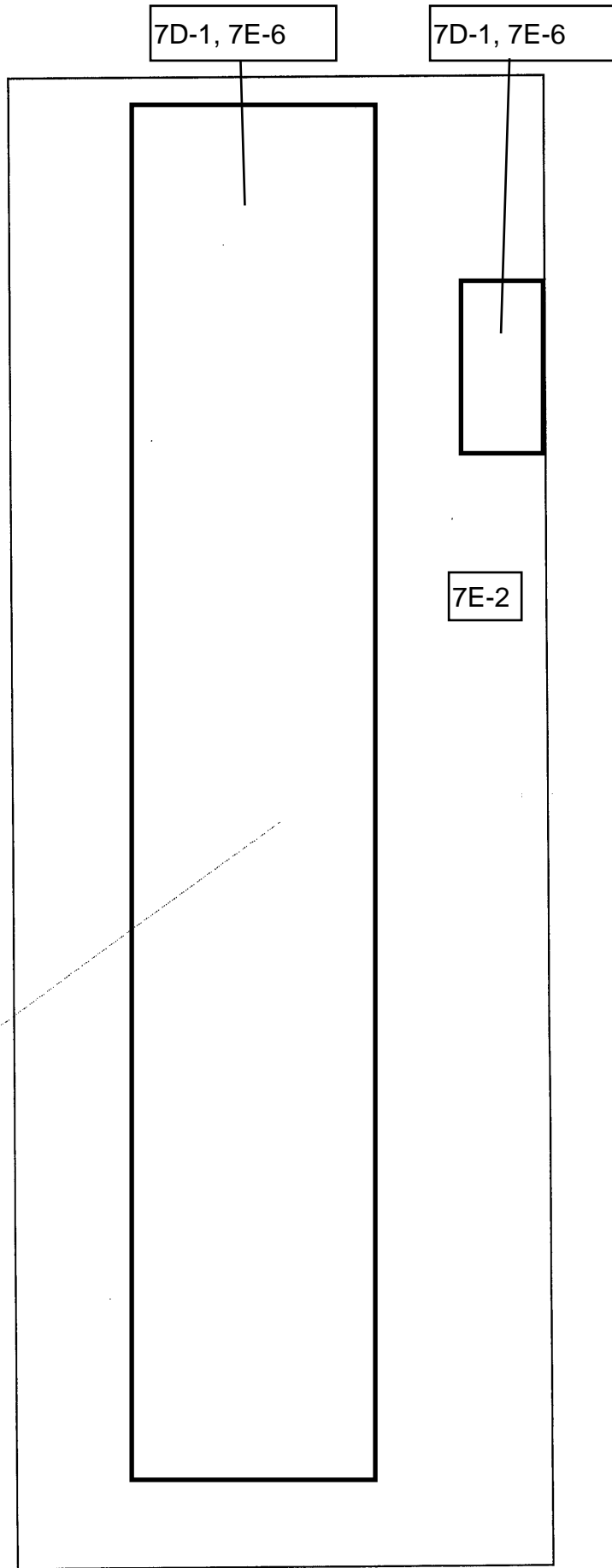

(b)(7)(A), (b)(7)(E)

HEMISPHERE Subpoena

Language

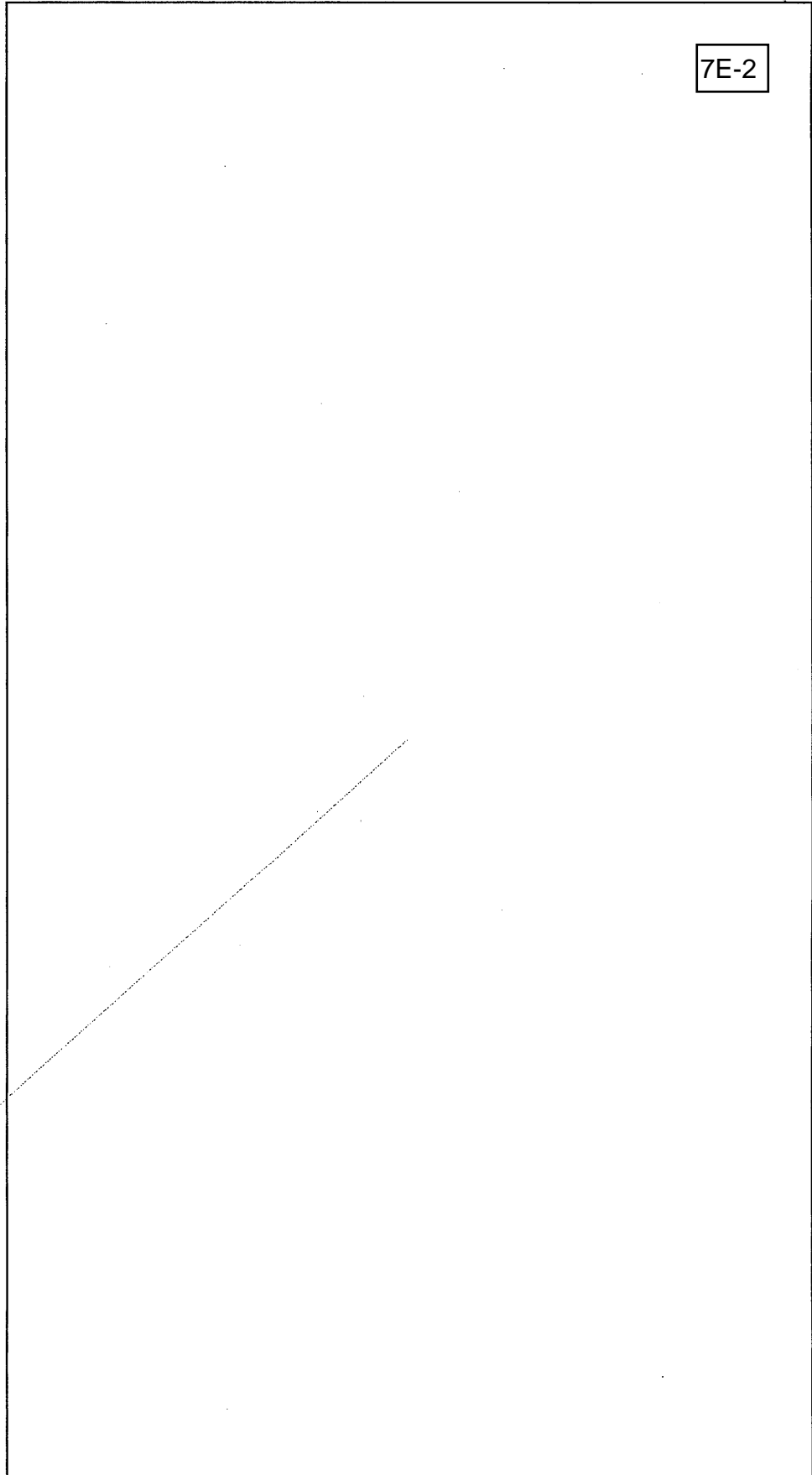

7E-2

16

(b)(6), (b)(7)(A), (b)(7)(C), (b)(7)(D), (b)(7)(E), (b)(7)(F)

HEMISPHERE Subpoena Date Range

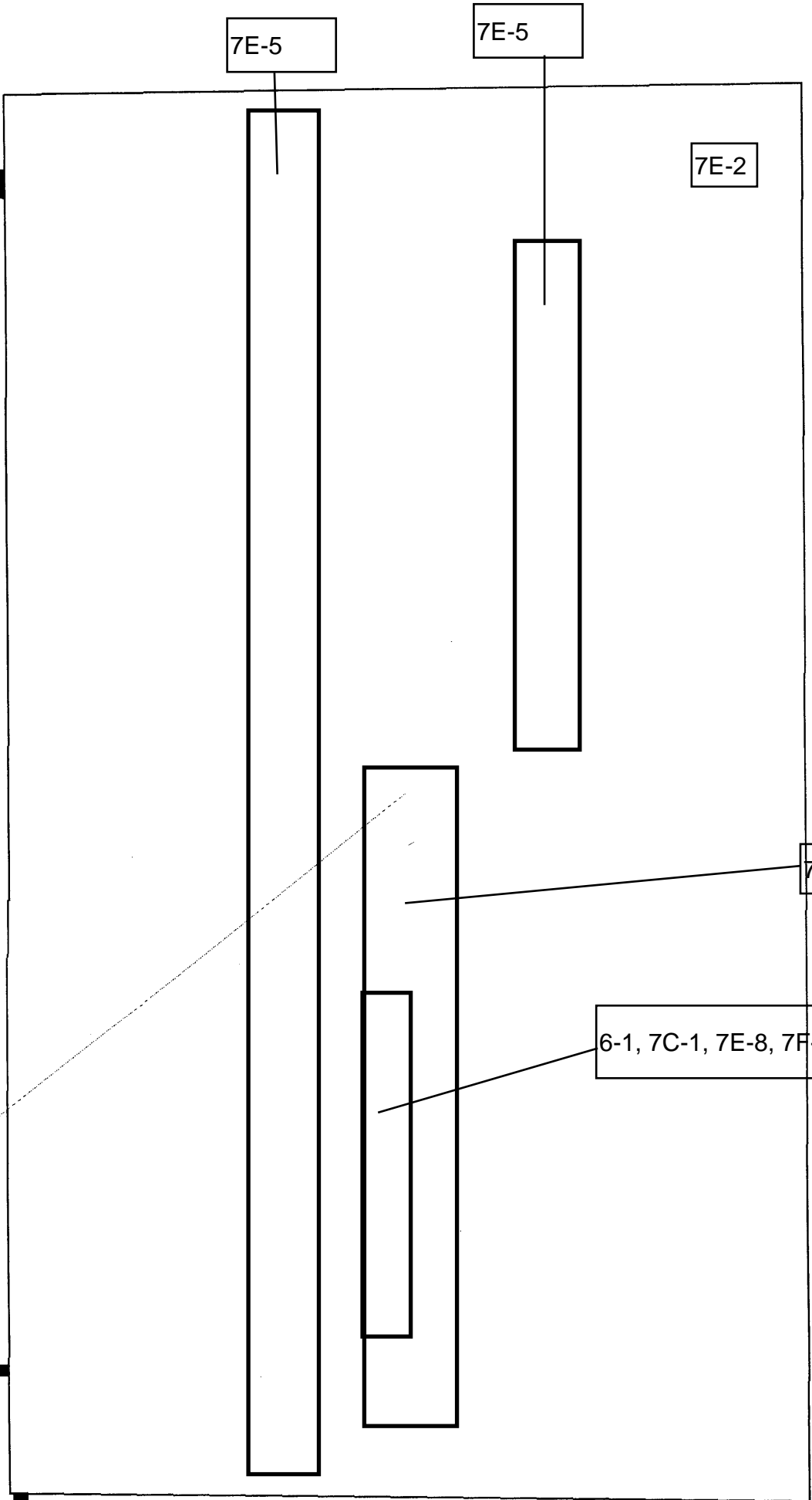

7E-2

HEMISPHERE

(b)(7)(A), (b)(7)(D), (b)(7)(E)

]

[Sample Subpoenas



**ATLANTA HIDTA
HIGH INTENSITY DRUG TRAFFICKING AREA
Office of National Drug Control Policy**

DEA

7D-7E-6

(b)(6), (b)(7)(A), (b)(7)(C), (b)(7)(D), (b)(7)(E), (b)(7)(F)

**U.S. DEPARTMENT OF JUSTICE/DRUG ENFORCEMENT ADMINISTRATION
SUBPOENA**

6-1, 7C-1, 7E-8, 7F-1

7E-2

7E-2

7D-1, 7E-6

6-1, 7C-1, 7E-8, 7F-

7E-

7E-5

**United States District Court
District of Maryland**

AO 110 (Rev. 12/89) - U.S. DISTRICT COURT (Rev. 1/2005)

(b) (6), (b) (7)(A), (b) (7)(B), (b) (7)(D), (b) (7)(E), (b) (7)(F)

7E-2

7E-5

6-1, 7C-1, 7E-8, 7F-1

7D-1, 7E-6

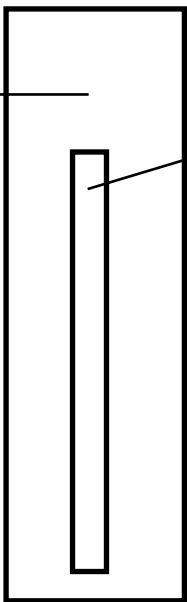

(b)(6), (b)(7)(A), (b)(7)(C), (b)(7)(D), (b)(7)(E), (b)(7)(F)

OTHER

(b)(7)(A), (b)(7)(C), (b)(7)(D), (b)(7)(E), (b)(7)(F)

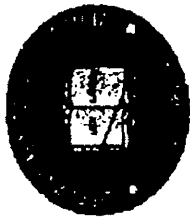

DEPARTMENT DE JUSTICIA
SAN JUAN, PUERTO RICO

SUSPOENA

7D-1, 7E-6

7E-5

7E-2

(b)(6), (b)(7)(A), (b)(7)(C), (b)(7)(D), (b)(7)(E), (b)(7)(F)

**IN THE CIRCUIT COURT OF THE NINTH JUDICIAL CIRUCIT
IN AND FOR ORANGE COUNTY, FLORIDA**

OTHER

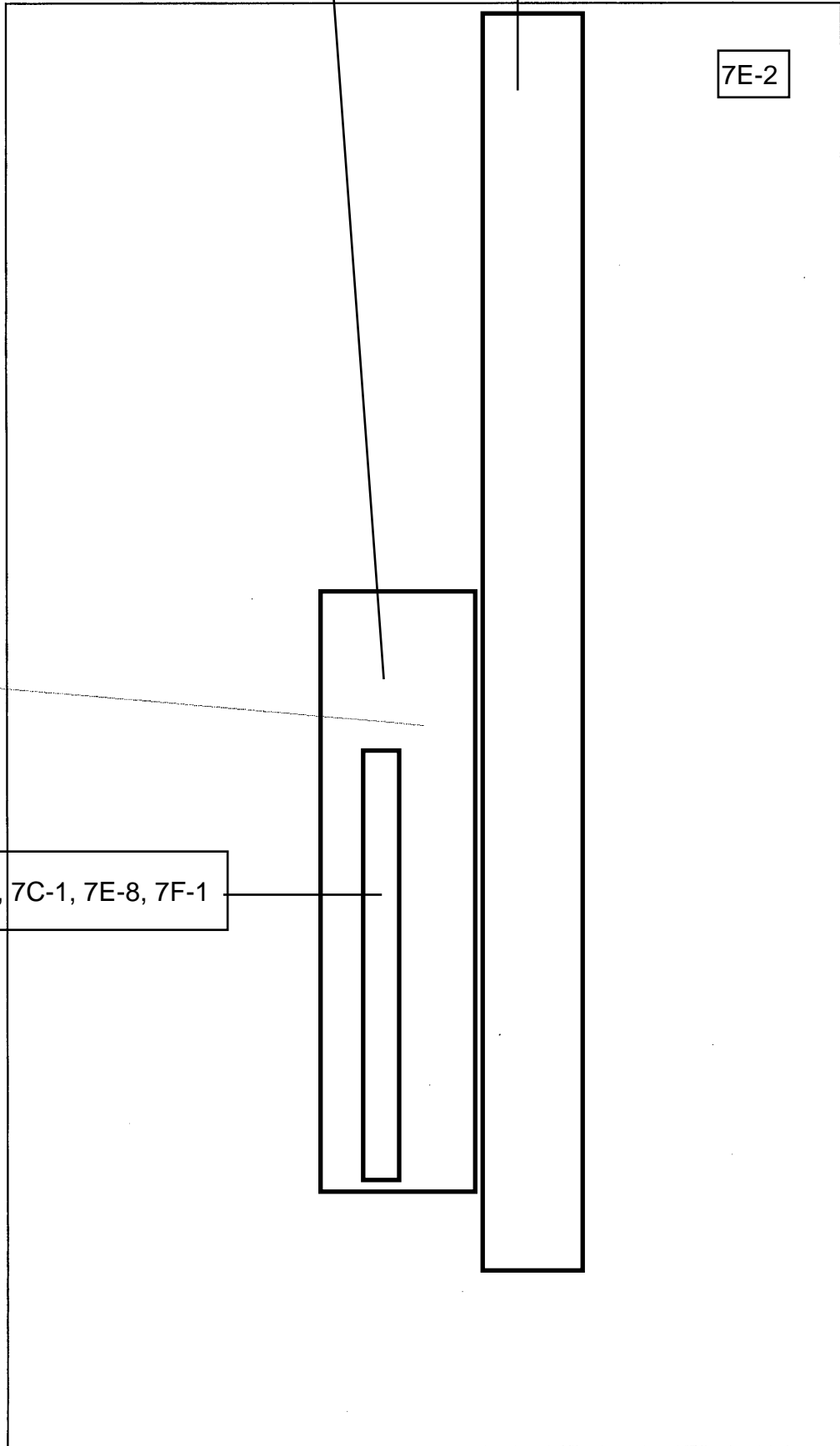

7D-1, 7E-6

7E-5

7E-2

6-1, 7C-1, 7E-8, 7F-1

HEMISPHERE Request Form

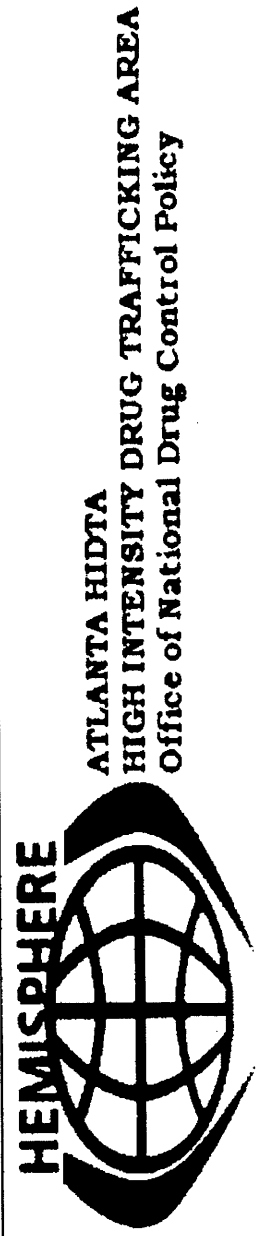

(b)(7)(A), (b)(7)(D), (b)(7)(E)

HEMISPHERE REQUEST FORM- PRIORITY RATING

Priority section: This section determines the urgency level of the request

7E-9

7E-2

7E-3

7E-3

7E-2

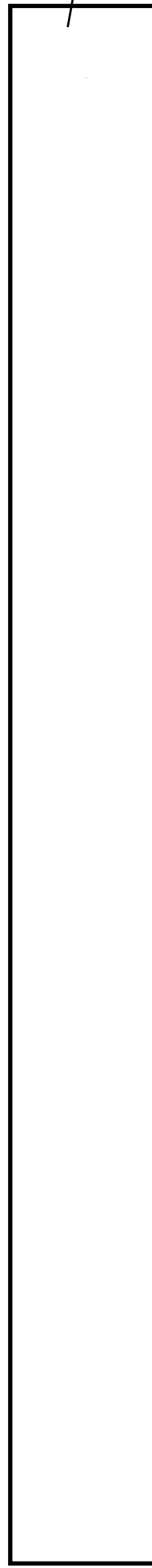

(b)(7)(A), (b)(7)(C), (b)(7)(D), (b)(7)(E)



Hemisphere

(b)(7)(A), (b)(7)(D), (b)(7)(E)

7E-2

7E-3

7E-3

(7)(A), (b)(7)(D), (b)(7)(E)

7E-3

b)(7)(A), (b)(7)(D), (b)(7)(E)

7E-3

7E-7

6-1, 7C-1, 7E-8, 7F-1

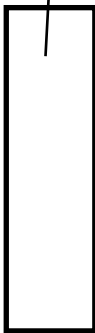

(b)(7)(A), (b)(7)(C), (b)(7)(D), (b)(7)(E), (b)(7)(F)

7E-3

7E-7

7E-1

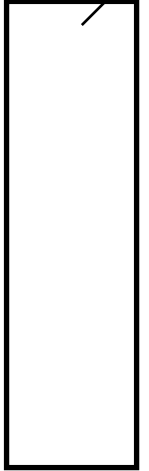

6-1, 7C-1, 7E-8, 7F-1

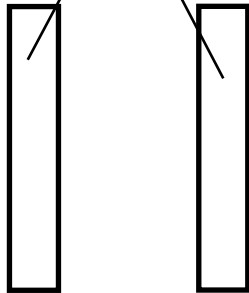

b(6), (b)(7)(A), (b)(7)(C), (b)(7)(D), (b)(7)(E), (b)(7)(F)

[
HEMISPHERE
]

Any
Questions?



INTERPRETING RESULTS

Wireless Coverage Areas in the U.S.

7D-1, 7E-6

(b)(7)(A), (b)(7)(D)

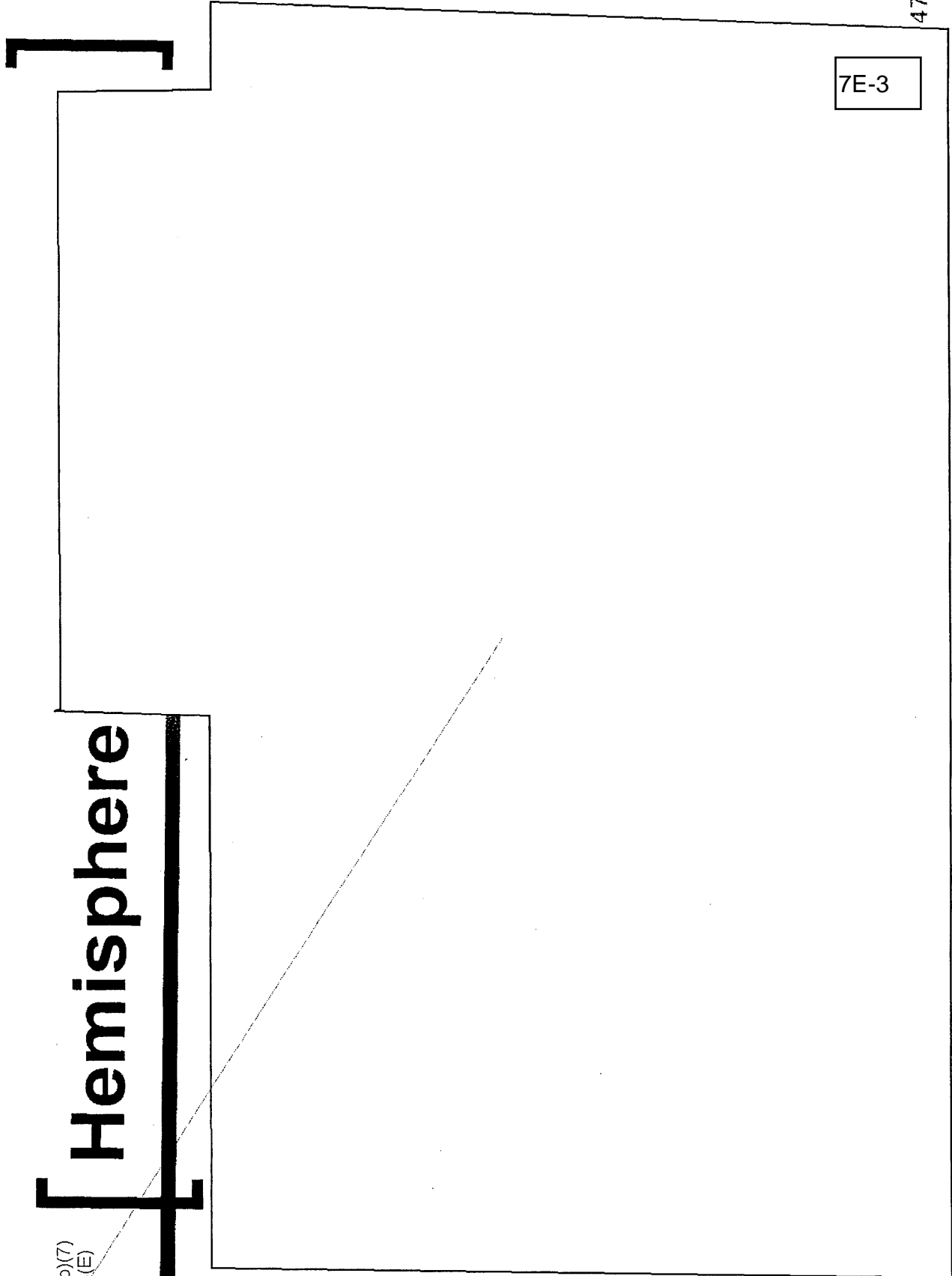

(b)(7)(A), (b)(7)(D), (b)(7)(E)

Hemisphere

Receiving your Request Results

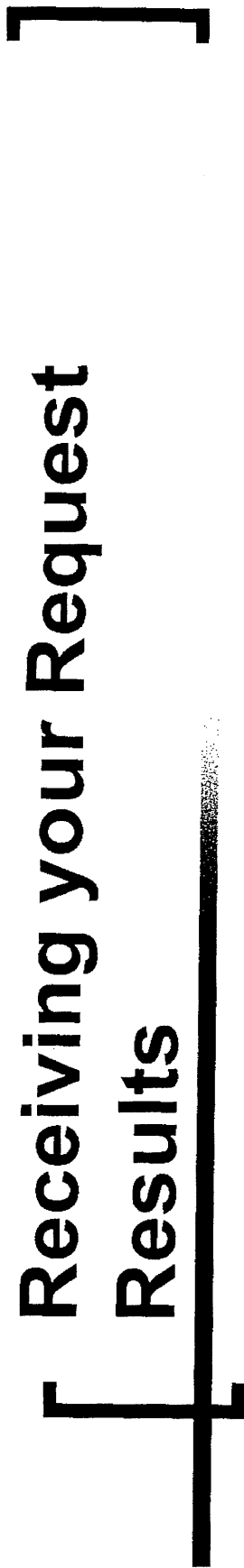

ATLANTA HIDTA
HIGH INTENSITY DRUG TRAFFICKING AREA
Office of National Drug Control Policy

7E-3

49

(b)(7)(A), (b)(7)(D), (b)(7)(E)

[Results Breakdown]

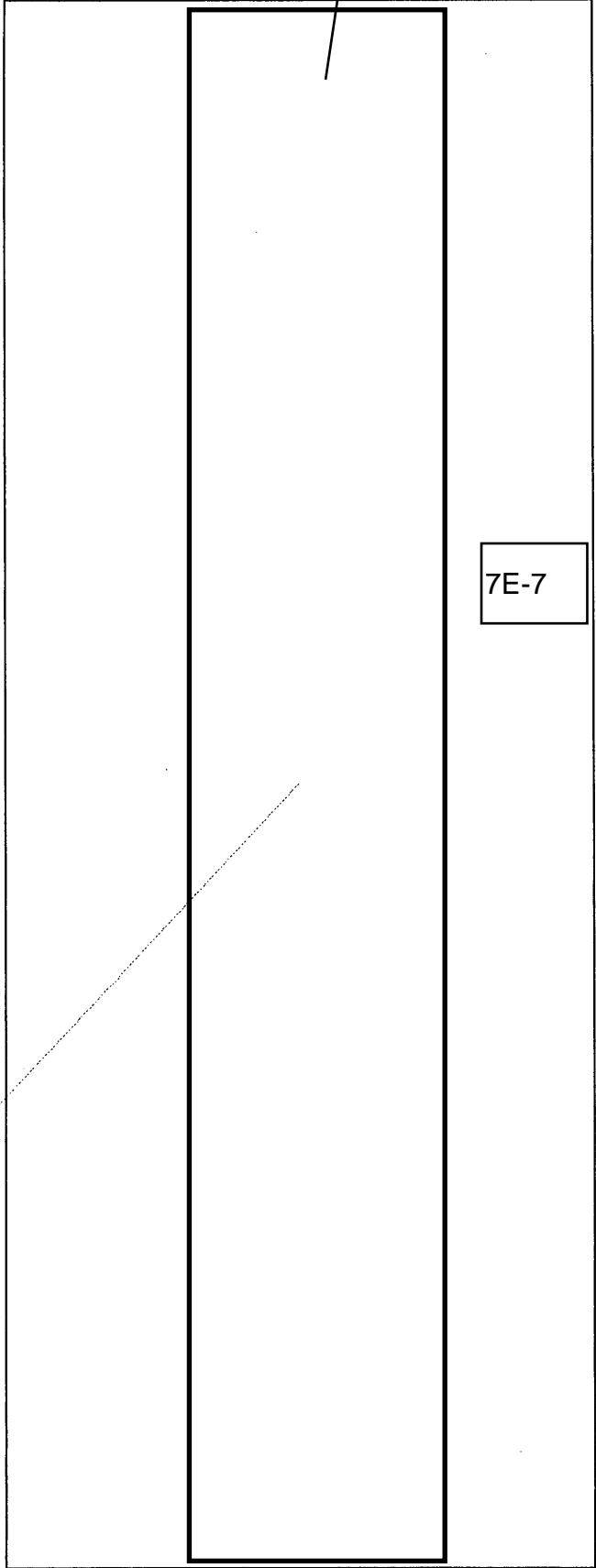

7E-7

7E-7

6-1, 7C-1, 7E-8, 7F-1



(b)(7)(A); (b)(7)(C); (b)(7)(D); (b)(7)(E); (b)(7)(F)

]

7E-7

[

(b)(7)(A), (b)(7)(E)



ATLANTA HIDTA
HIGH INTENSITY DRUG TRAFFICKING AREA
Office of National Drug Control Policy

7E-3

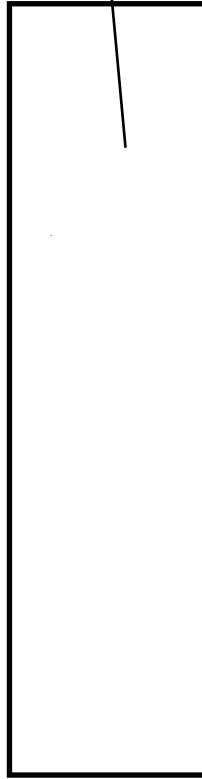

7E-7

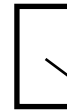
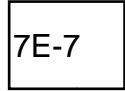

7D-1, 7E-6

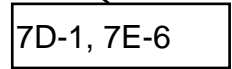

6-1, 7C-1, 7E-8, 7F-1

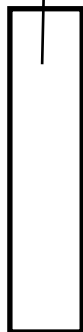
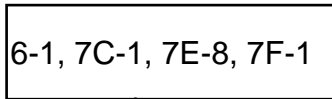

(b)(7)(A), (b)(7)(C), (b)(7)(D), (b)(7)(E), (b)(7)(F)

7E-7

(b)(7)(A), (b)(7)(C), (b)(7)(D), (b)(7)(E)

7E-7

(7)(A), (b)(7)(C), (b)(7)(D), (b)(7)(E)

7E-7

(b)(7)(A), (b)(7)(E)

7E-7

7E-3

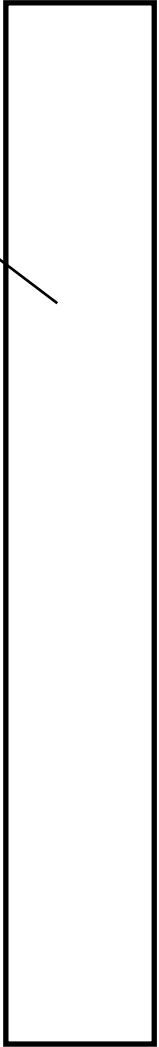
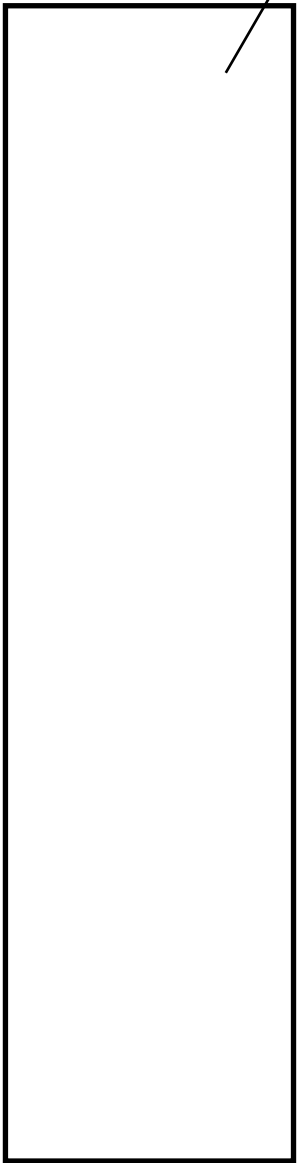

(b)(7)(A), (b)(7)(C), (b)(7)(D), (b)(7)(E)

7E-7

b)(7)(A), (b)(7)(C), (b)(7)(D), (b)(7)(E)

7E-7

(7)(A), (b)(7)(C), (b)(7)(D), (b)(7)(E)

7E-7

b)(7)(A), (b)(7)(C), (b)(7)(D), (b)(7)(E)

7E-7

7E-3

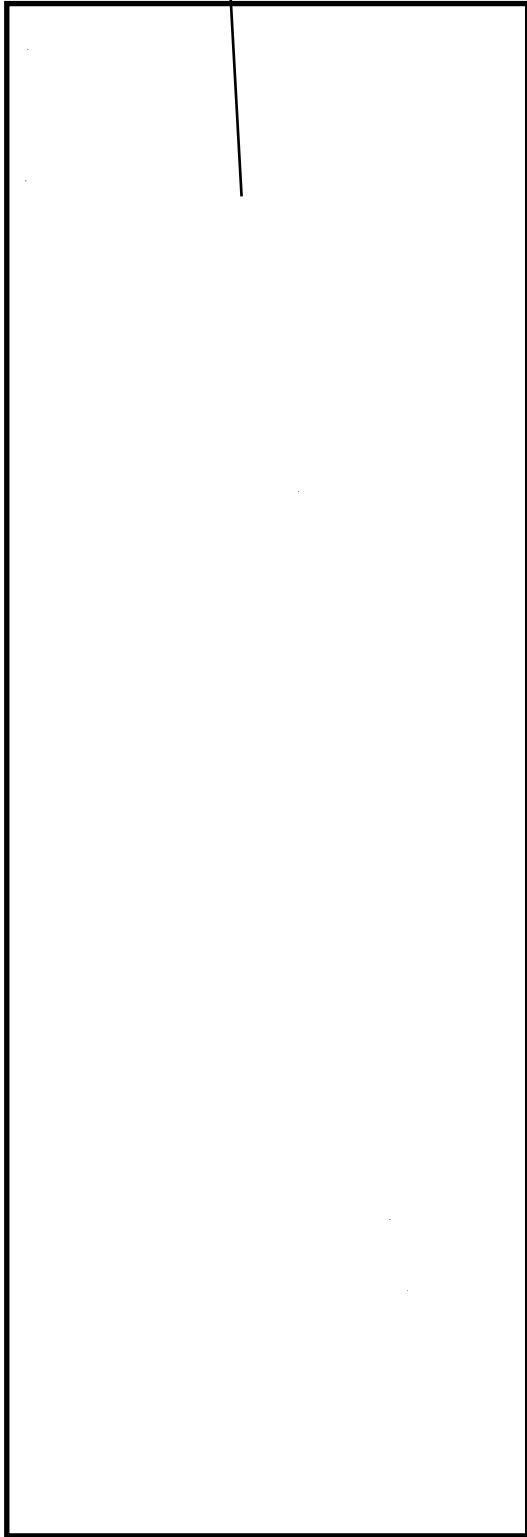

o)(7)(A),(b)(7)(C),(b)(7)(D),(b)(7)(E)

7E-7

7E-3



b)(7)(A), (b)(7)(C), (b)(7)(D), (b)(7)(E)

7E-7

7E-3

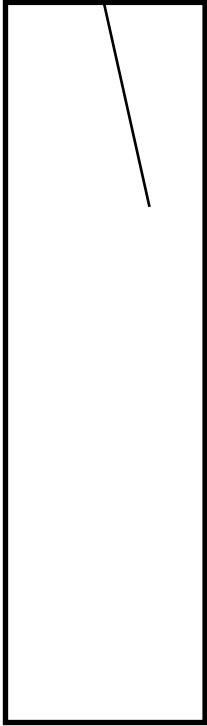

7E-3

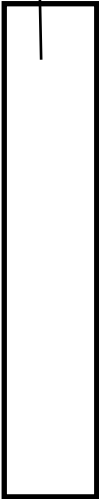

(7)(A), (b)(7)(C), (b)(7)(D), (b)(7)(E)

7E-7

b)(7)(A), (b)(7)(C), (b)(7)(D), (b)(7)(E)

7E-7

7E-3

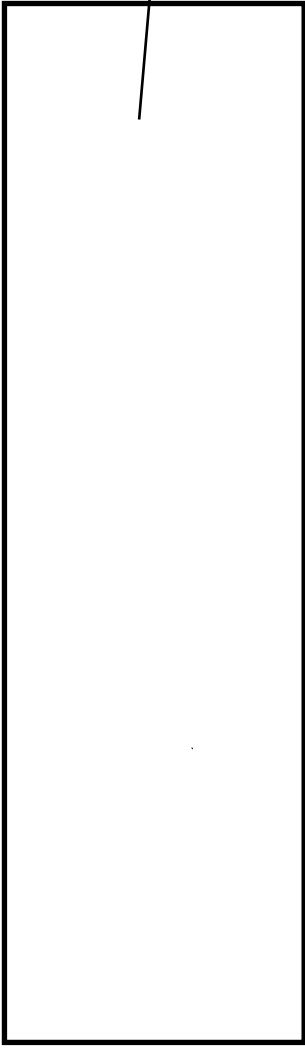

(7)(A), (b)(7)(C), (b)(7)(D), (b)(7)(E)

7E-7

(b)(7)(A), (b)(7)(C), (b)(7)(D), (b)(7)(E)

(b)(7)(A),(b)(7)(C),(b)(7)(D),(b)(7)(E)

7E-7

(b)(7)(A),(b)(7)(C),(b)(7)(D),(b)(7)(E)

7E-7

7E-3

[Redacted]

(b)(7)(A),(b)(7)(C),(b)(7)(D),(b)(7)(E)

7E-7

(b)(7)(A),(b)(7)(C),(b)(7)(D),(b)(7)(E)

7E-7

71

(b)(7)(A), (b)(7)(D), (b)(7)(E)

[Hemisphere Features]

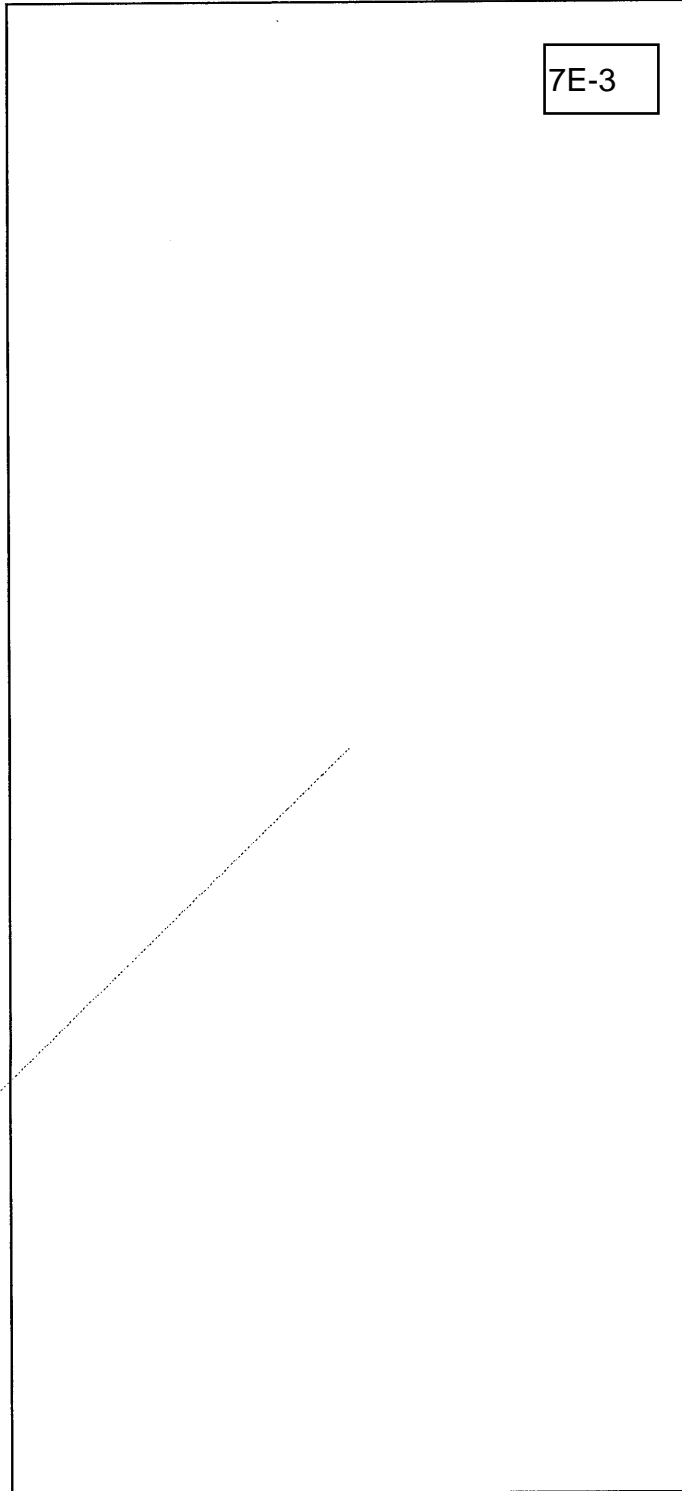

(b)(7)(A),(b)(7)(C),(b)(7)(D),(b)(7)(E)

7E-7

7E-3

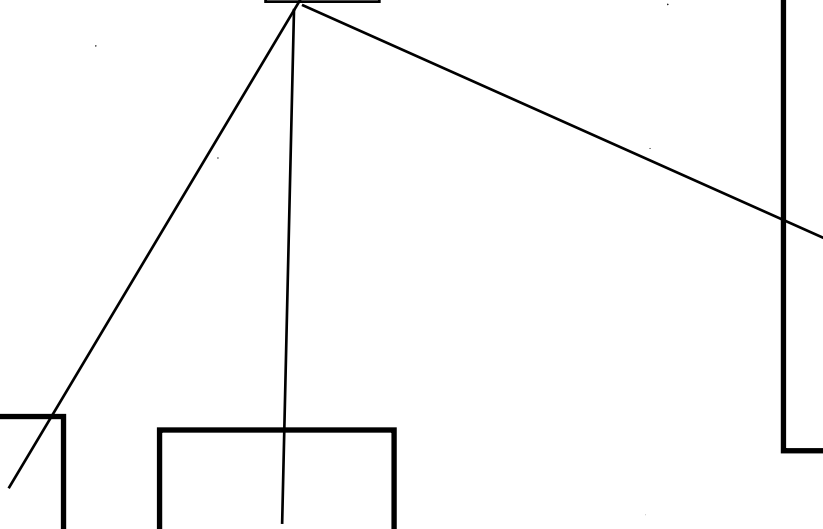
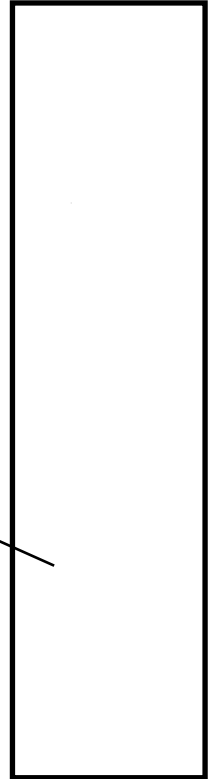
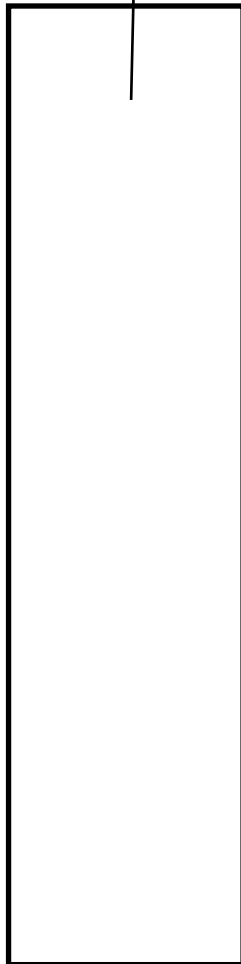
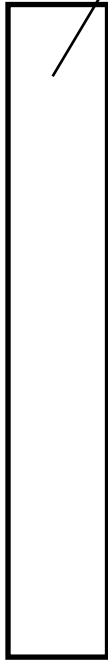

(b)(7)(A),(b)(7)(C),(b)(7)(D),(b)(7)(E)

7E-7

7E-3

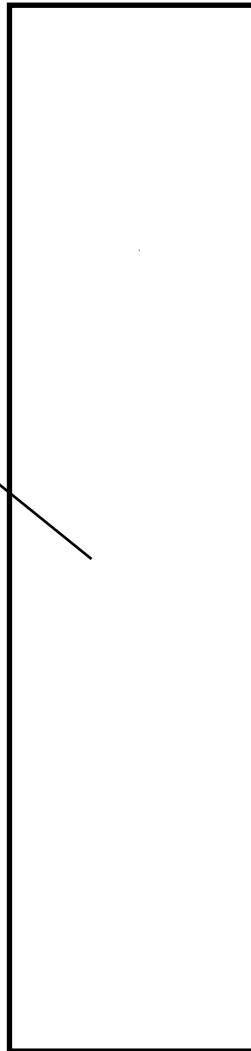
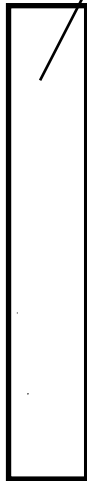

(b)(7)(A),(b)(7)(C),(b)(7)(D),(b)(7)(E)

7E-3

7E-7

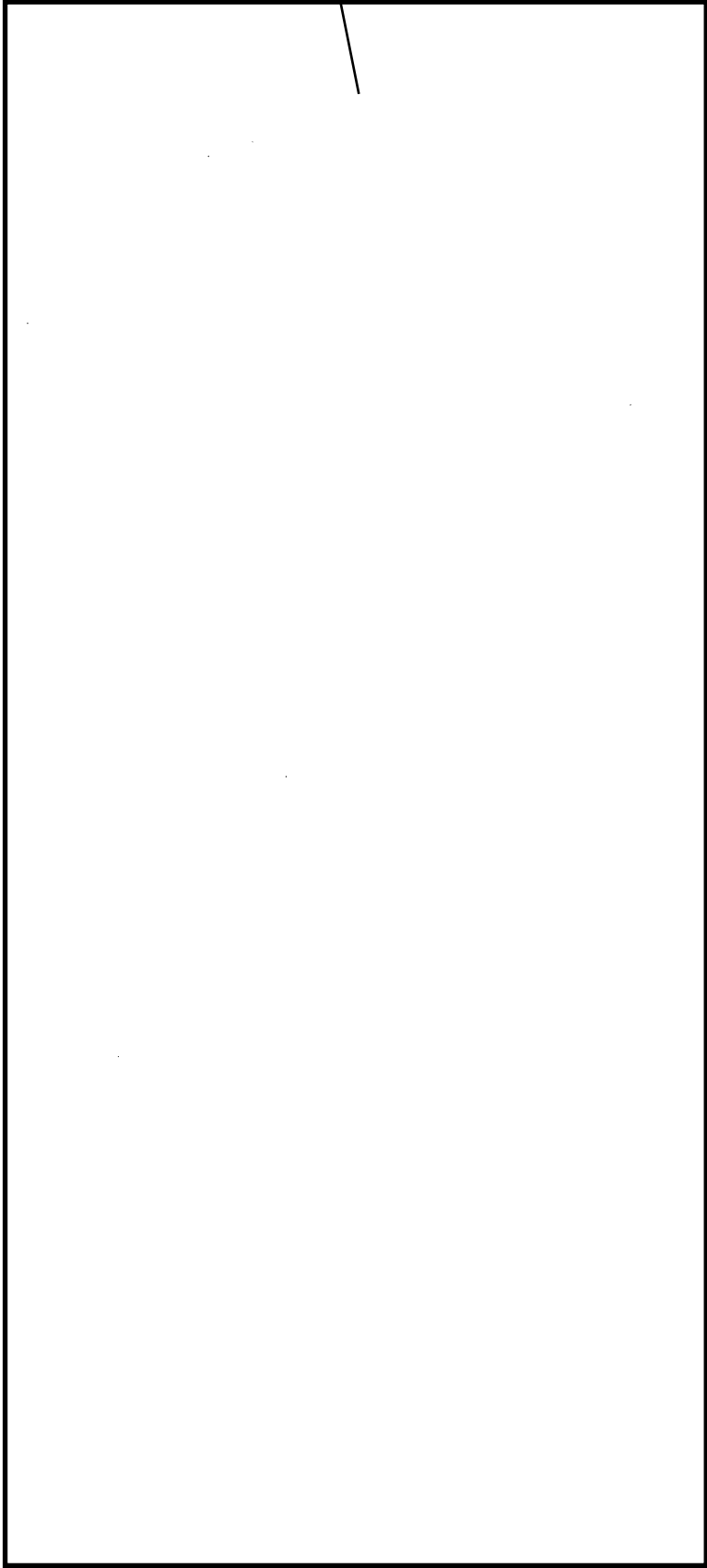

(b)(7)(A),(b)(7)(C),(b)(7)(D),(b)(7)(E)

7E-7

7E-3

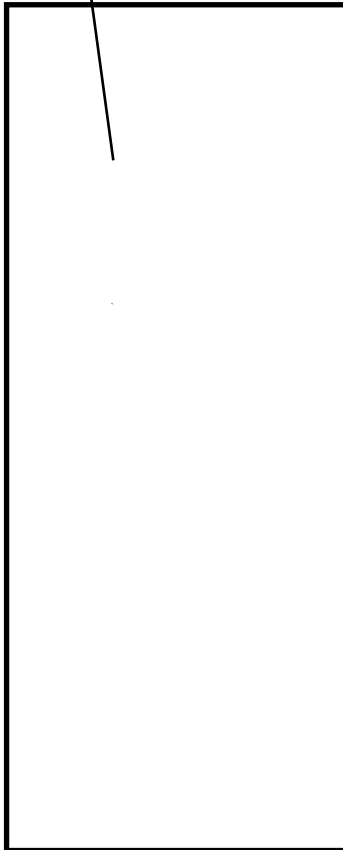

(b)(7)(A), (b)(7)(C), (b)(7)(D), (b)(7)(E)

7E-7

(b)(7)(A), (b)(7)(D), (b)(7)(E)

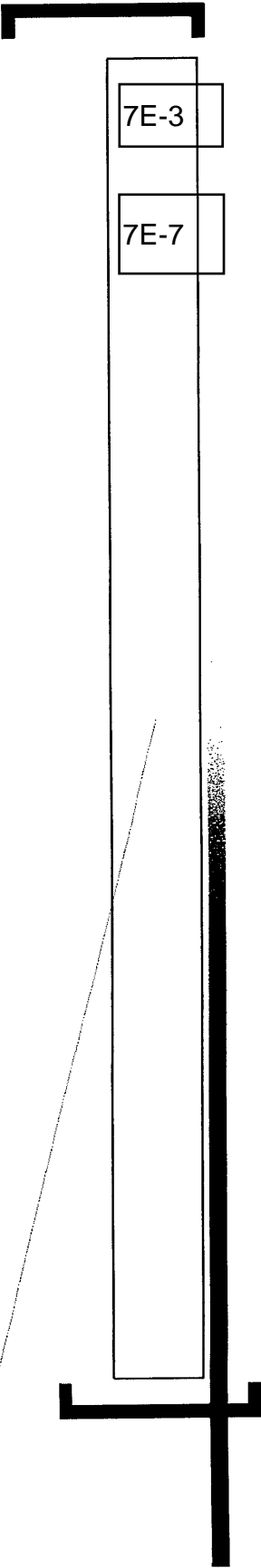

ATLANTA HIDTA
HIGH INTENSITY DRUG TRAFFICKING AREA
Office of National Drug Control Policy

7E-3

7E-7

(b)(7)(A), (b)(7)(D), (b)(7)(E)

(b)(7)(A),(b)(7)(C),(b)(7)(D),(b)(7)(E)

7E-7

]

7E-7

[

(b)(7)(A), (b)(7)(D), (b)(7)(E)



ATLANTA HIDTA
HIGH INTENSITY DRUG TRAFFICKING AREA
Office of National Drug Control Policy

(b)(7)(A),(b)(7)(C),(b)(7)(D),(b)(7)(E)

7E-7

(b)(7)(A), (b)(7)(D), (b)(7)(E)

]

[

7E-7

HEMISPHERE

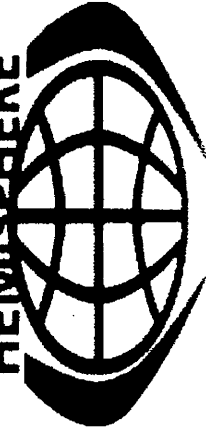

**ATLANTA HIDTA
HIGH INTENSITY DRUG TRAFFICKING AREA
Office of National Drug Control Policy**

(b)(7)(A),(b)(7)(C),(b)(7)(D),(b)(7)(E)

7E-7

(b)(7)(A), (b)(7)(D), (b)(7)(E)

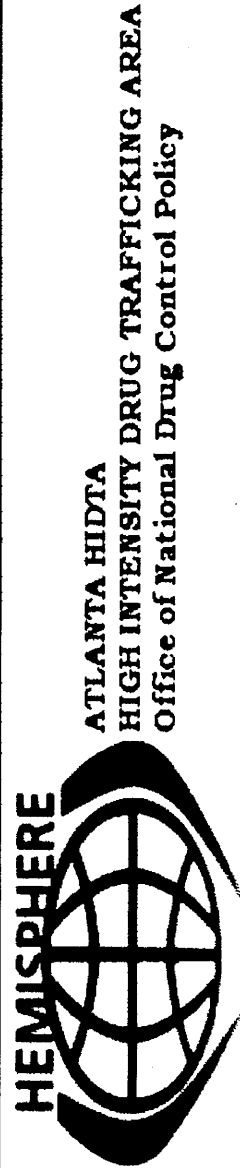
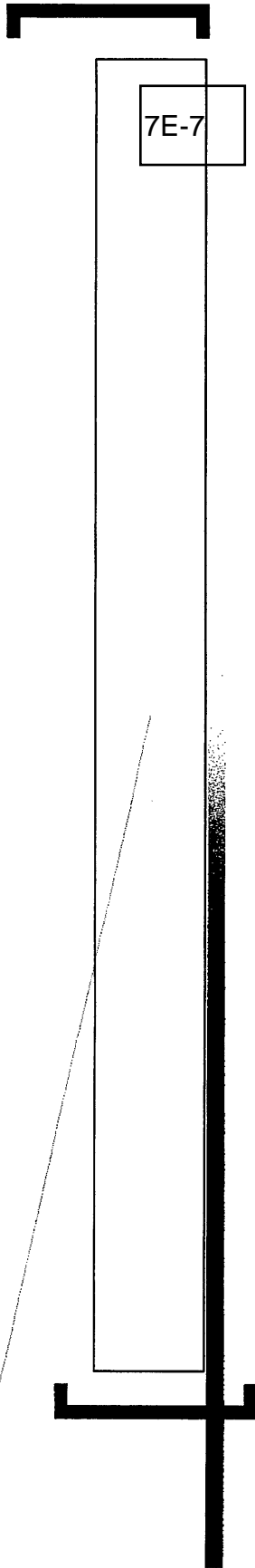

7E-7

(b)(7)(A), (b)(7)(D), (b)(7)(E)

7E-7

(b)(7)(A), (b)(7)(C), (b)(7)(D), (b)(7)(E)

(b)(7)(A),(b)(7)(C),(b)(7)(D),(b)(7)(E)

7E-7

[Hemisphere Reports]

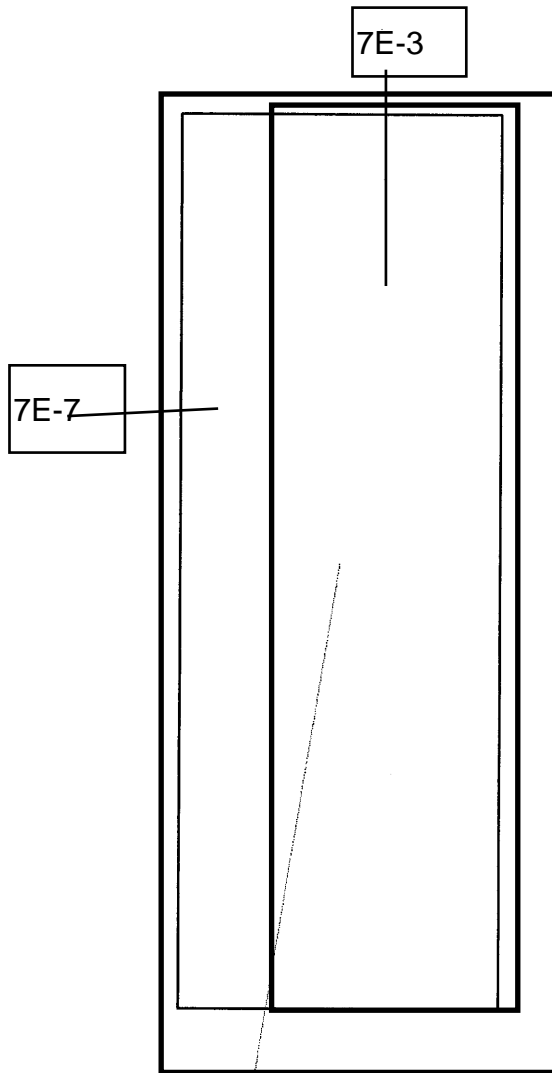

(b)(7)(A), (b)(7)(D), (b)(7)(E)

]

[Redacted]
7E-7
7E-3

Report

[



**ATLANTA HIDTA
 HIGH INTENSITY DRUG TRAFFICKING AREA
 Office of National Drug Control Policy**

7E-7

7E-3

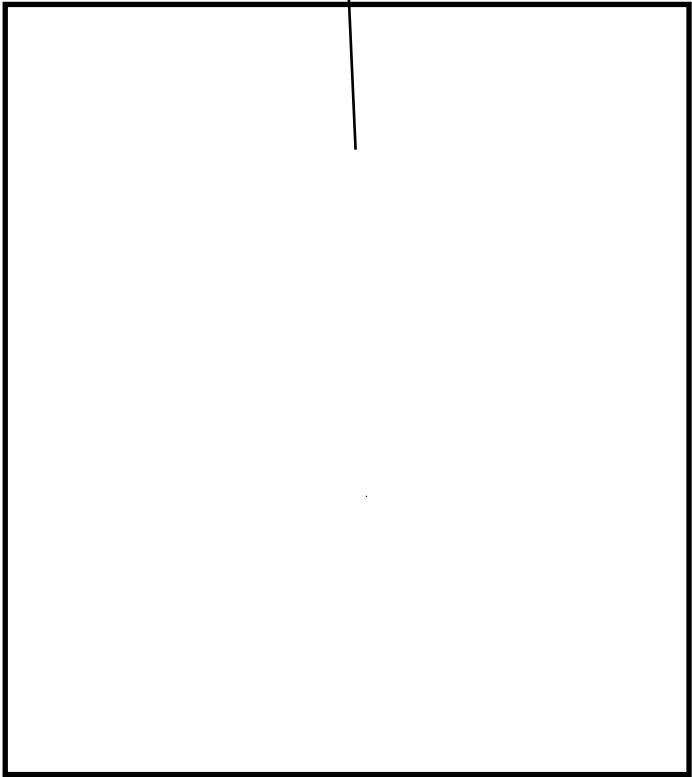

7D-1, 7E-6



6-1, 7C-1, 7E-8, 7F-1



b)(6), (b)(7)(A), (b)(7)(C), (b)(7)(D), (b)(7)(E), (b)(7)(F)

(b)(7)(A),(b)(7)(C),(b)(7)(D),(b)(7)(E)

7E-7

7E-3

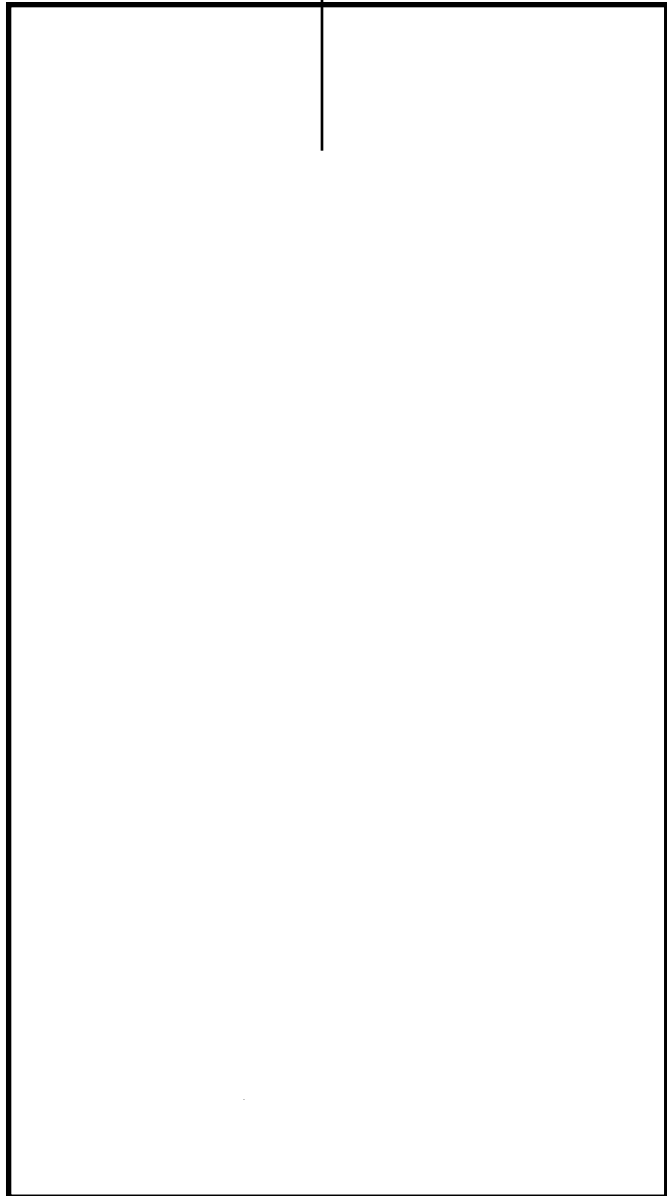

]

[Redacted area containing text and two boxes labeled 7E-3 and 7E-7]

(b)(7)(A), (b)(7)(D), (b)(7)(E)

7E-3

7E-7



ATLANTA HIDTA
HIGH INTENSITY DRUG TRAFFICKING AREA
Office of National Drug Control Policy

7E-3

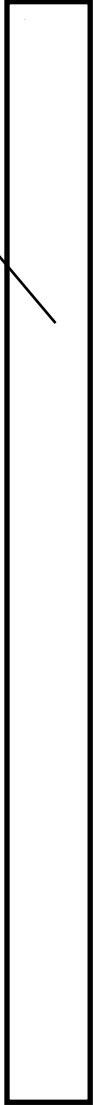
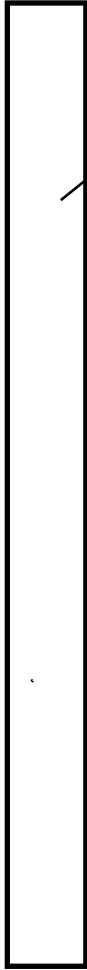

7E-7

6-1, 7C-1, 7E-8, 7F-1

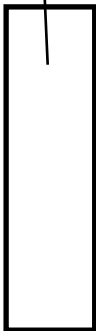

(b)(6), (b)(7)(A), (b)(7)(C), (b)(7)(D), (b)(7)(E), (b)(7)(F)

[
HEMISPHERE
]

Any
Questions?

]

[Success Stories]

95

(b)(7)(A),(b)(7)(C),(b)(7)(D),(b)(7)(E)

6-2, 7C-2

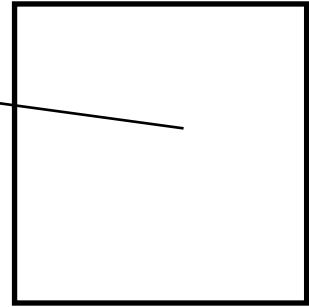

7E-5

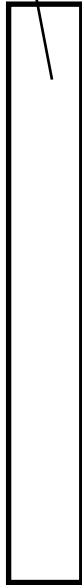

7E-3

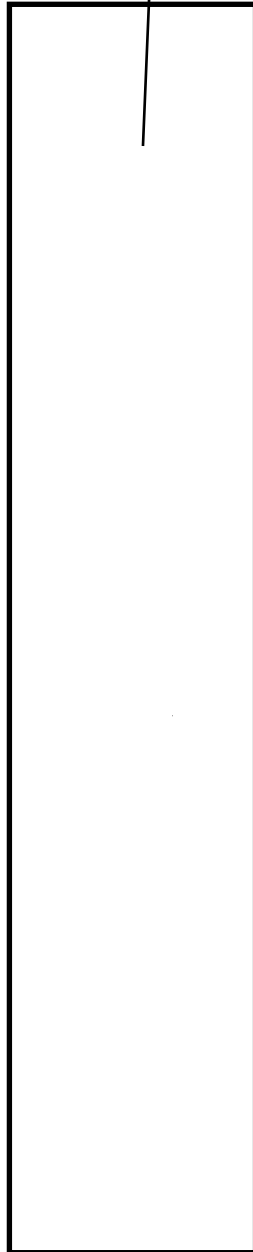

7E-10

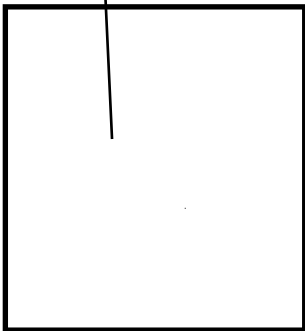

7E-3

(b)(7)(A),(b)(7)(D),(b)(7)(E)

[Redacted]

7E-10

(b)(7)(A), (b)(7)(C), (b)(7)(D), (b)(7)(E)

7E-3

7E-10

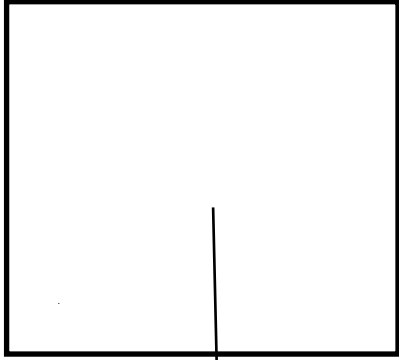

7E-5

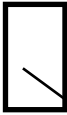
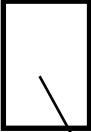
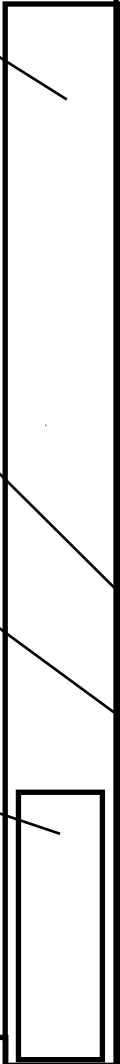
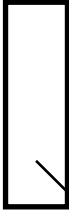

6-1, 7C-1, 7E-8, 7F-1

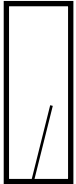
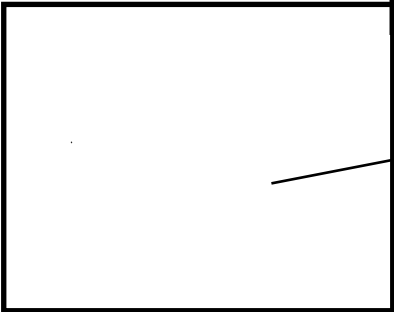

6-2, 7C-2

(b)(7)(A),(b)(7)(C),(b)(7)(D),(b)(7)(E)

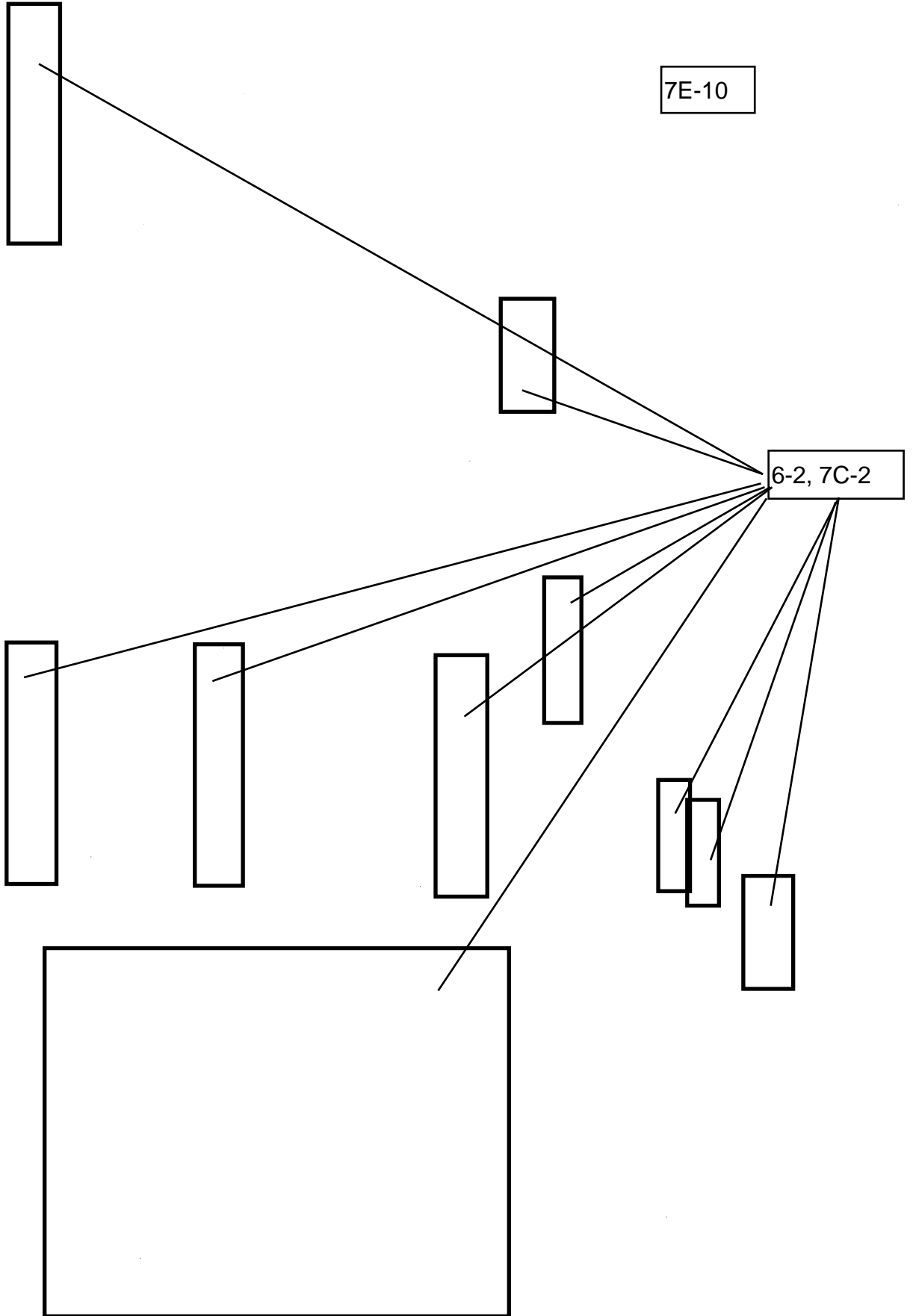

(b)(7)(A),(b)(7)(C),(b)(7)(D),(b)(7)(E)

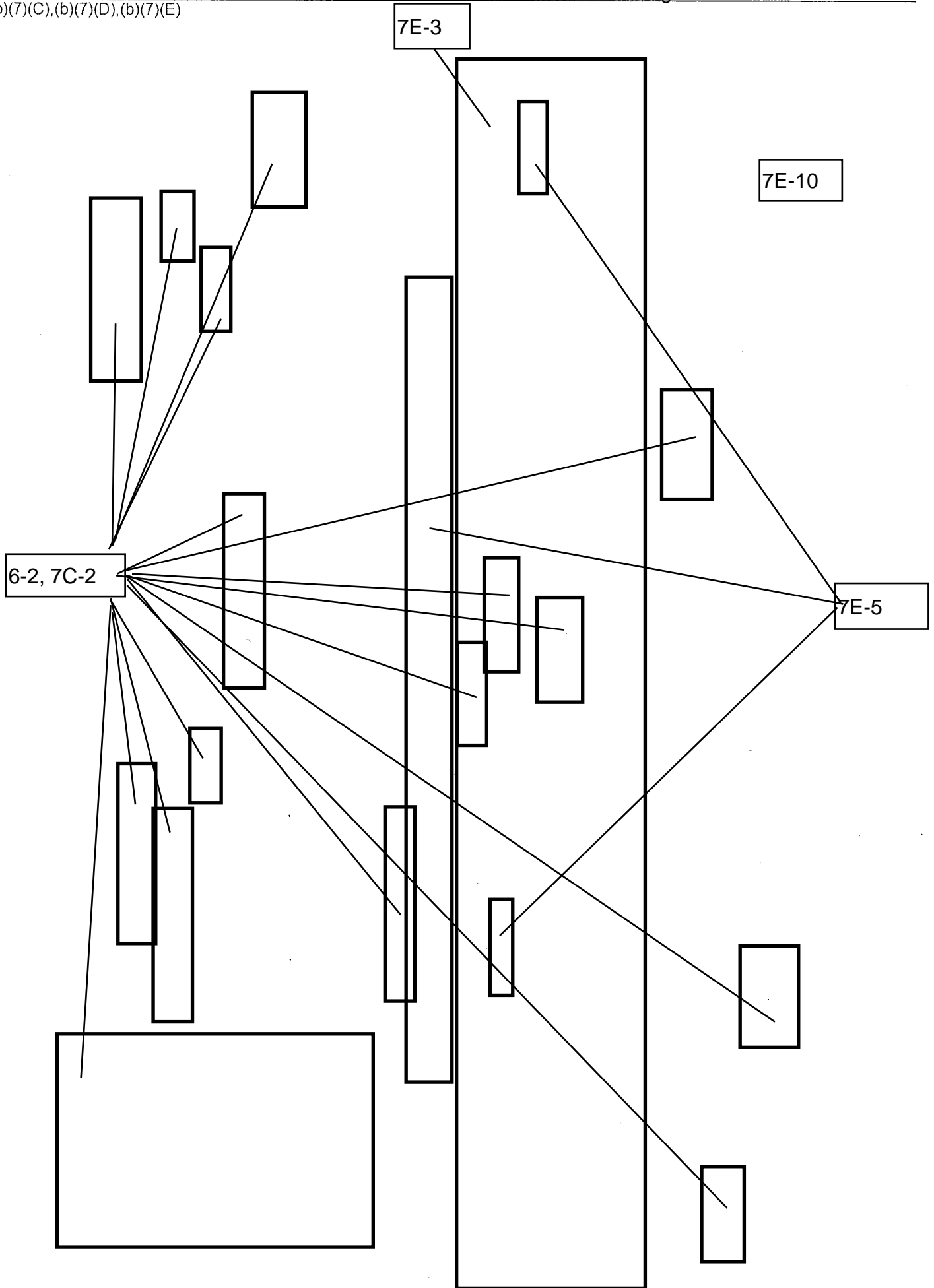

[Hemisphere Summary]

101

(b)(7)(A), (b)(7)(E), (b)(7)(F)

[Hemisphere Summary]

- The Hemisphere Project is a *law enforcement sensitive* program funded by ONDCP

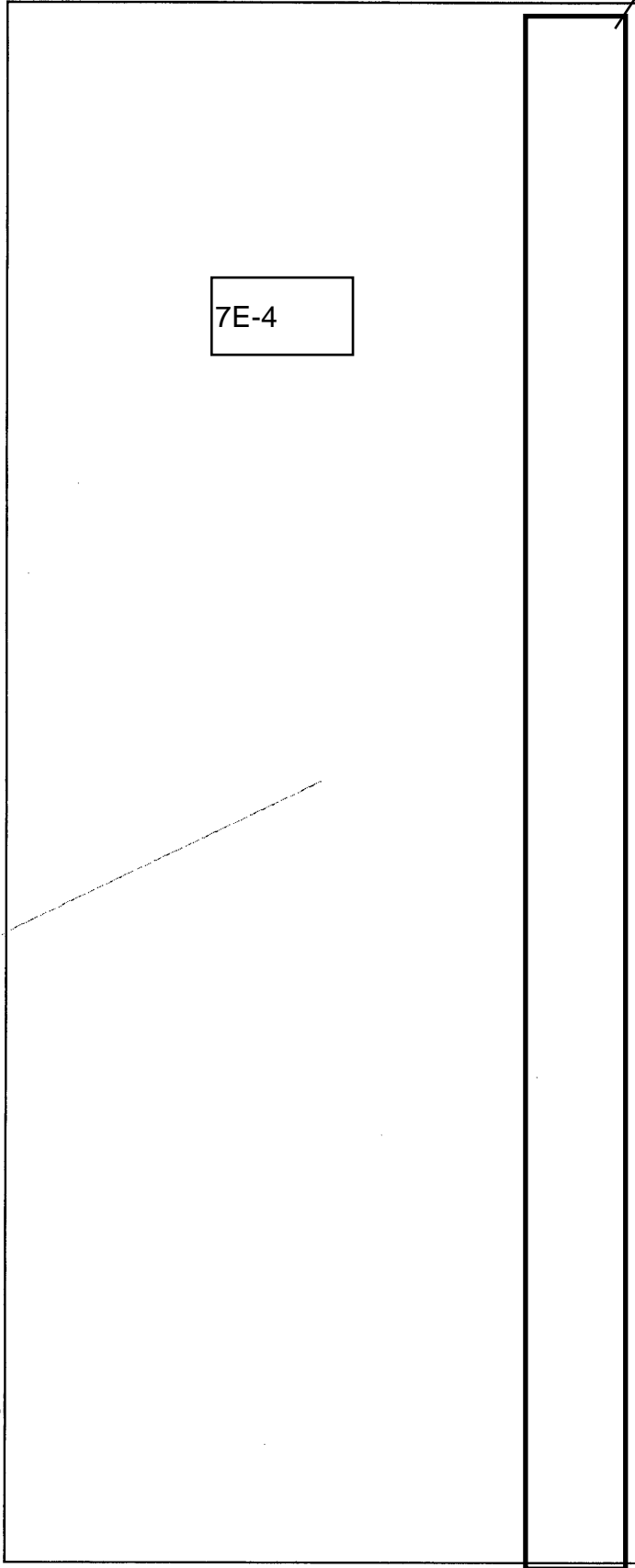

7E-2

102

(b)(7)(A), (b)(7)(D), (b)(7)(E)

[Hemisphere Summary]

7E-4	7E-2	7E-7	7E-3

103

(b)(7)(A), (b)(7)(D), (b)(7)(E)

[Hemisphere Summary]

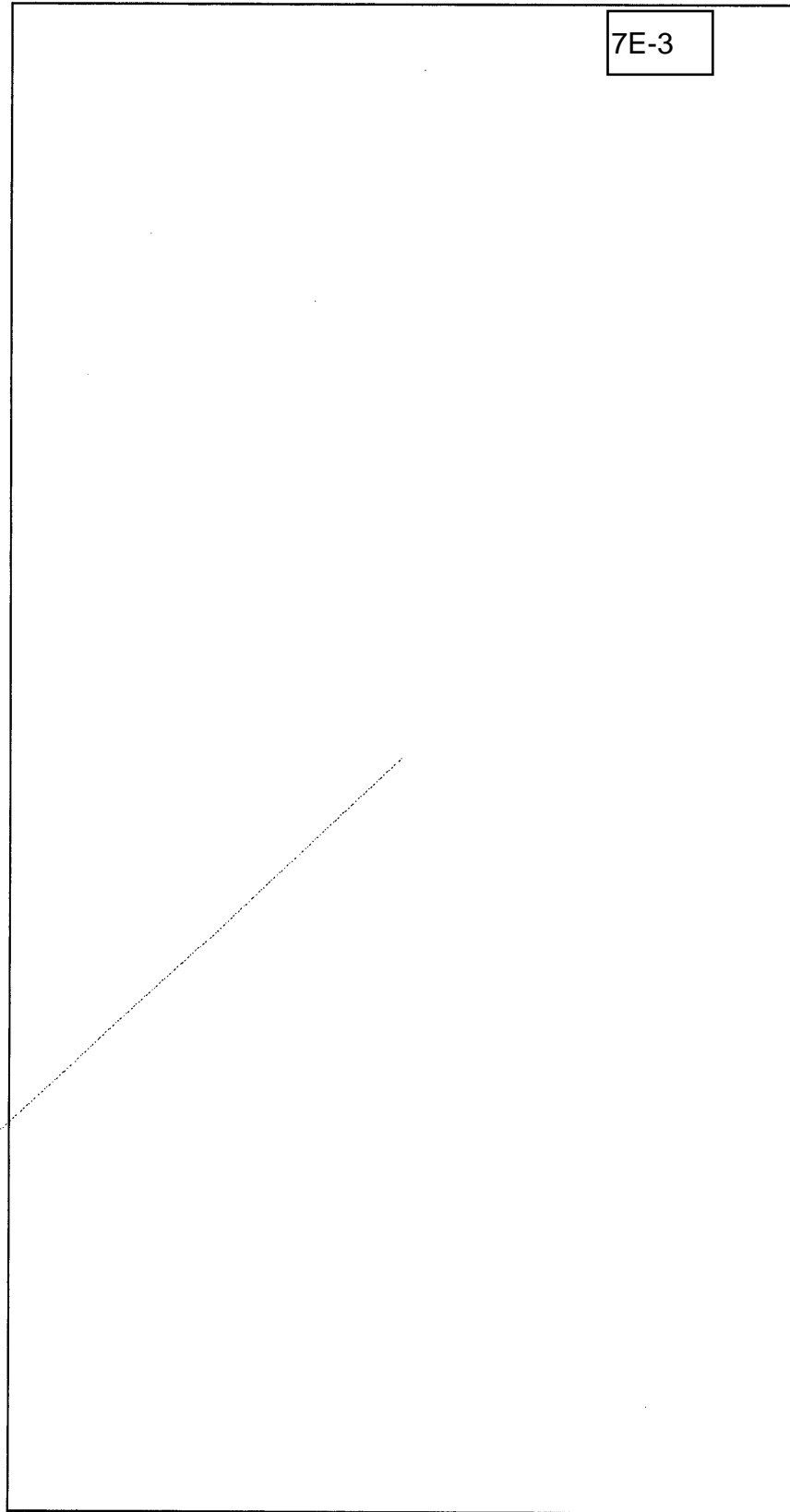

104

(b)(7)(A), (b)(7)(C), (b)(7)(E), (b)(7)(F)

HEMISPHERE Project Info

--	--

7E-4

7E-1

105

[HEMISPHERE **]**

**Any
Questions?**

]

HEMISPHERE Request Form

[

HEMISPHERE

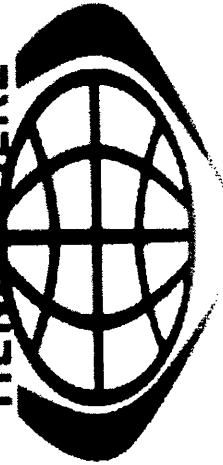

**ATLANTA HIDTA
HIGH INTENSITY DRUG TRAFFICKING AREA
Office of National Drug Control Policy**



Hemisphere Project Request Form ATLANTA HIDTA

HIGH INTENSITY DRUG TRAFFIC KING AREA
Office of National Drug Control Policy

Print Entire Form

Please Fax When Complete

HRC Fax: (b)(7)(A), (b)(7)(E)

7E-1

Master Case Number: [] **Priority:** [] **Current Date:** 2008-11-05 13:07:55

HIDTA Point of Contac Name: [] **Email Results To:** []

POC Phone Number: [] **Email Notification Of Coma To:** []

Name: [] **Case # assigned by the requesting agency** (circled callout)

Number: [] **Email Results To:** [] **7E-9** (circled callout)

Email Notification Of Co [] **7E-2** (circled callout)

Case Name (if applicable): [] **(b)(7)(A), (b)(7)(E)** (circled callout)

DTO Name (if applicable): []

HIDTA Initiative: [] **HIDTA Initiative OR Law Enforcement Agency:** []

Yes No **Squad Name:** []

Time Zone Results Requested In: []

HEMISPHERE REQUEST FORM- PRIORITY RATING

(b)(7)(A), (b)(7)(D),
(b)(7)(E)

Priority section: This section determines the urgency level of the request

7E-2

7E-9

7E-3

7E-9



Hemisphere Project Request Form ATLANTA HIDTA

HIGH INTENSITY DRUG TRAFFIC KING AREA
Office of National Drug Control Policy

Print Entire Form

Please Fax When Complete

HRC Fax: (b)(7)(A), (b)(7)(E)

7E-1

Master Case Number: Priority: Current Date: 2008-11-05 13:07:55

HIDTA Point of Contac Name: Email Results To:

OC Phone Number: Email Notifi...tion Of Completion To:

Requestor Name: Email Results To:

Phone Number: Email Notification Of Comple...tion:

Case Name (if applicable):

HIDTA Initiative: Enforcement:

Squad Name:

Time Zone Results Requested In:

Yes No

Name of your HIDTA Point of Contact

Telephone # of your HIDTA Point of Contact

E-mail of your HIDTA Point of Contact



Hemisphere Project Request Form ATLANTA HIDTA

Print Entire Form

Please Fax When Complete

HRC Fax : (b)(7)(A), (b)(7)(E)

7E-1

HIGH INTENSITY DRUG TRAFFIC KING AREA
Office of National Drug Control Policy

Master Case Number: **Priority:** **Current Date:** 2008-11-05 13:07:55

HIDTA Point of Contac Name: **Email Results To:**

POC Phone Number: **Email Notification Of Completion To:**

Requestor Name: **Email Results To:**

Requestor Phone Number: **Email Notification Of Completion To:**

Requesters Name **Requesters E-Mail**

Requesters Telephone #

Time Zone Requested In:

Requesters **No**

Squad

Initiative OR

Placement A

Case Name (if applicable):



Hemisphere Project Request Form ATLANTA HIDTA

Print Entire Form

Please Fax When Complete

HEMISPHERE
OFFICE OF NATIONAL DRUG CONTROL POLICE
HIGHTSMITH DRUG TRAFFICKING AREA
Office of National Drug Control Police

HRC Fax: (b)(7)(A), (b)(7)(E)

7E-1

Master Case Number: **Priority:** **Current Date:** 2008-11-05 13:07:55

HIDTA Point of Contact Name: **Email Results To:**

Name of the Drug Trafficking Organization: **Email Notification Of Completion To:**

Operator Name: **Email Results To:**

Operator Phone Number: **Email Notification Of Completion To:**

Case Name (if applicable):

Case Name (if applicable):

DTO Name (if applicable):

HIDTA Initiative: **HIDTA Initiative OR Law Enforcement Agency:**

Yes No **Squad Name:**

Time Zone Results Requested In:

Name assigned by the agency to the case.

Name of the Drug Trafficking Organization



HIGH INTENSITY DRUG TRAFFICKING AREA
Office of National Drug Control Policy

Hemisphere Project Request Form ATLANTA HIDTA

Print Entire Form

Please Fax When Complete

HRC Fax: (b)(7)(A), (b)(7)(E)

7E-1

Master Case Number: Priority: Current Date: 2008-11-05 13:07:55

Contact Name: Email Results To:

Email Notification of Completion To:

Email Results To:

Email Notification Number:

Case Name:

Indicate HIDTA / Non HIDTA and What Agency the Request Should Be Credited to

Indicate What Squad Within Your Agency the Request Should Be Credited to and the Time Zone needed.

DTO Name (if applicable):

HIDTA Initiative: HIDTA Initiative OR Law Enforcement Agency:

Yes No Squad Name:

Time Zone Results Requested In:

7E-2

7E-3

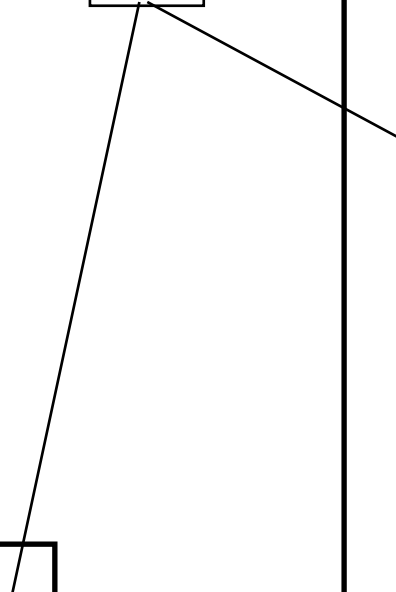

(b)(7)(A), (b)(7)(C), (b)(7)(D), (b)(7)(E)

(b)(7)(A), (b)(7)(D), (b)(7)(E)

HEMISPHERE REQUEST FORM-

]

[

Hemisphere

include:

7E-3

7E-2

7E-4

[

7E-5

7E-7

7E-3

7E-2

7E-4

Hemisphere

(b)(7)(A), (b)(7)(D), (b)(7)(E)

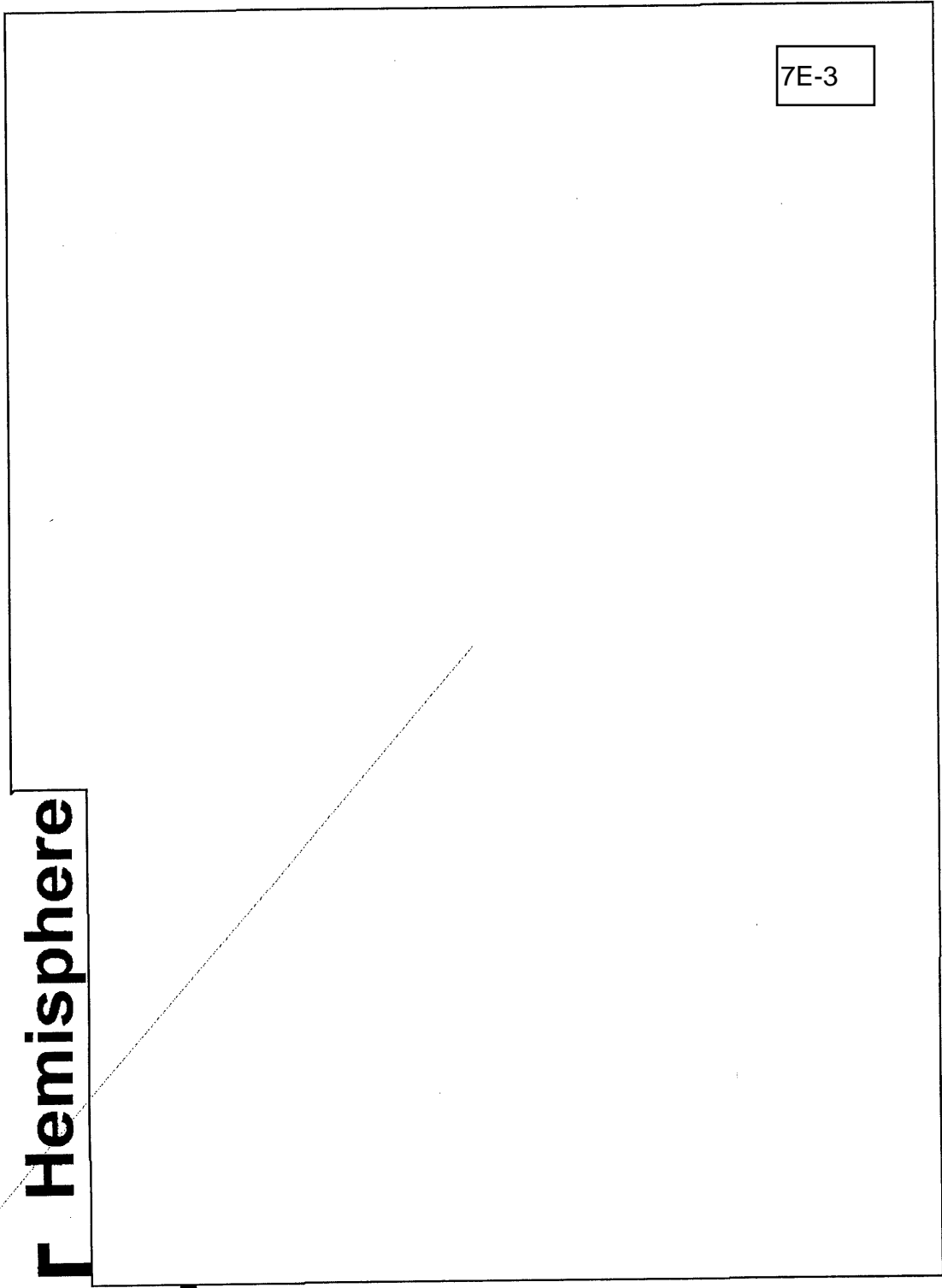

7E-3

(b)(7)(A), (b)(7)(D), (b)(7)(E)

Hemisphere



7E-2

7E-3

Hemisphere

(b)(7)(A), (b)(7)(D), (b)(7)(E)

]

[Sample Requests

(b)(7)(A), (b)(7)(C), (b)(7)(D), (b)(7)(E)

Yes No

Squad Name:

Time Zone Results Requested In:

Eastern Standard Time (EST -5)

7E-2

7E-5

[Redacted]

7E-5

(b)(7)(A), (b)(7)(C), (b)(7)(D), (b)(7)(E)

UNITED STATES DEPARTMENT OF JUSTICE

Yes No

Squad Name:

Time Zone Results Requested In:

Eastern Standard Time (EST -5)

7E-2

7E-3

7E-5

[Redacted]

(b)(7)(A), (b)(7)(C), (b)(7)(D), (b)(7)(E)

Yes No

Squad Name:

DEA

Time Zone Results Requested In:

Eastern Standard Time (EST -5)

7E-2

7E-3

[Subpoenas]

HEMISPHERE

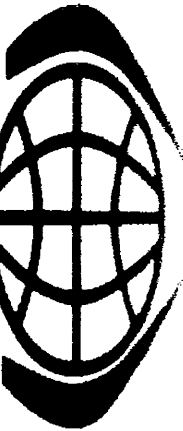

**ATLANTA HIDTA
HIGH INTENSITY DRUG TRAFFICKING AREA
Office of National Drug Control Policy**

(b)(6), (b)(7)(A), (b)(7)(C), (b)(7)(D), (b)(7)(E), (b)(7)(F)

HEMISPHERE Subpoena Language

7E-2

(b)(7)(A), (b)(7)(D), (b)(7)(E), (b)(7)(F)

[HEMISPHERE Subpoena Recipient]

**All Hemisphere subpoenas should have the following
in the recipient/address section...**

7E-2

7D-1, 7E-6

(b)(7)(A), (b)(7)(E)

HEMISPHERE Subpoena

Language

]

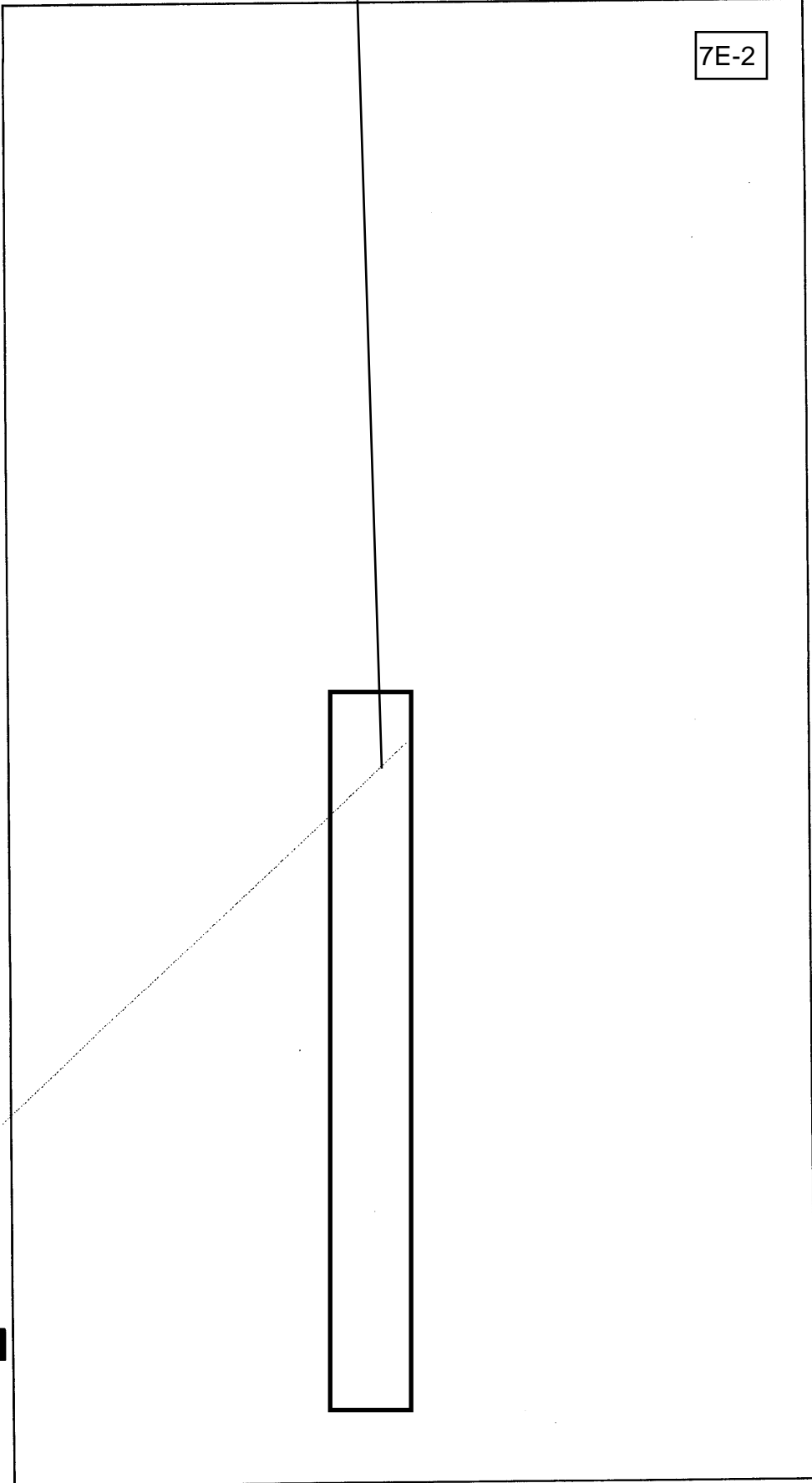

7D-1, 7E-6

7E-2

(b)(6), (b)(7)(A), (b)(7)(C), (b)(7)(D), (b)(7)(E), (b)(7)(F)

HEMISPHERE Subpoena Date Range

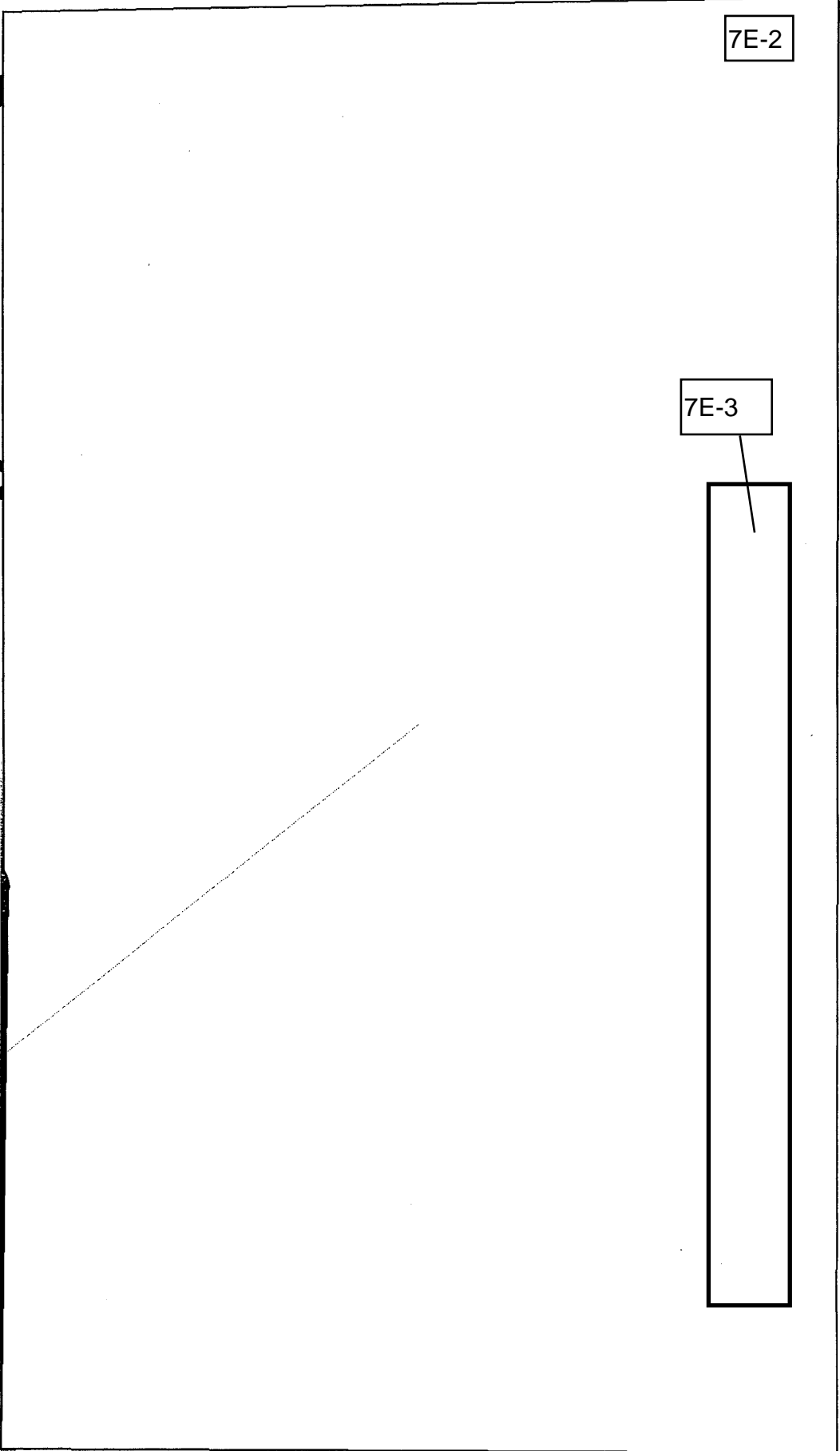

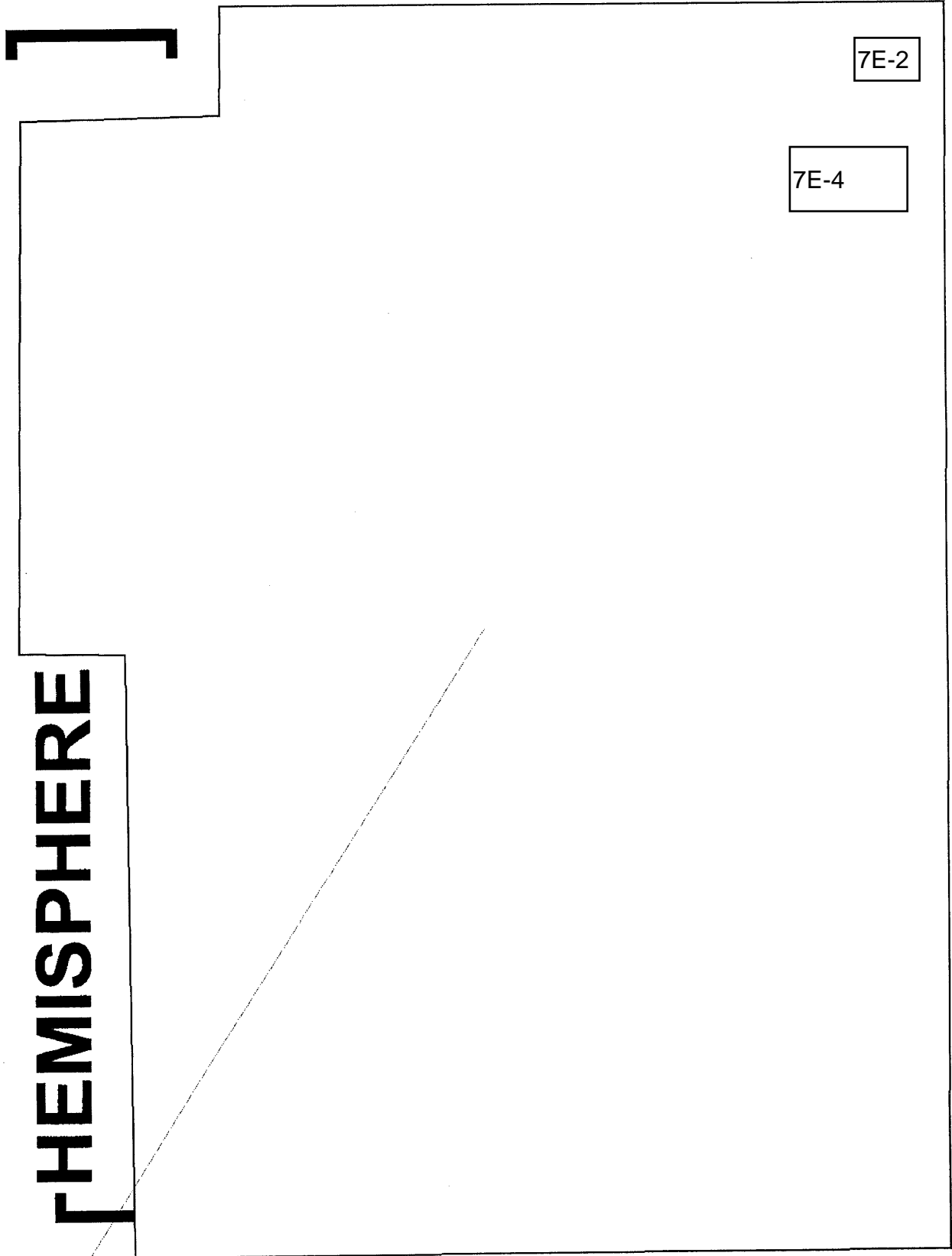

HEMISPHERE

7E-2

7E-4

(b)(7)(A), (b)(7)(D), (b)(7)(E)

(b)(7)(A), (b)(7)(E)

**HEMISPHERE
Subpoena Language**

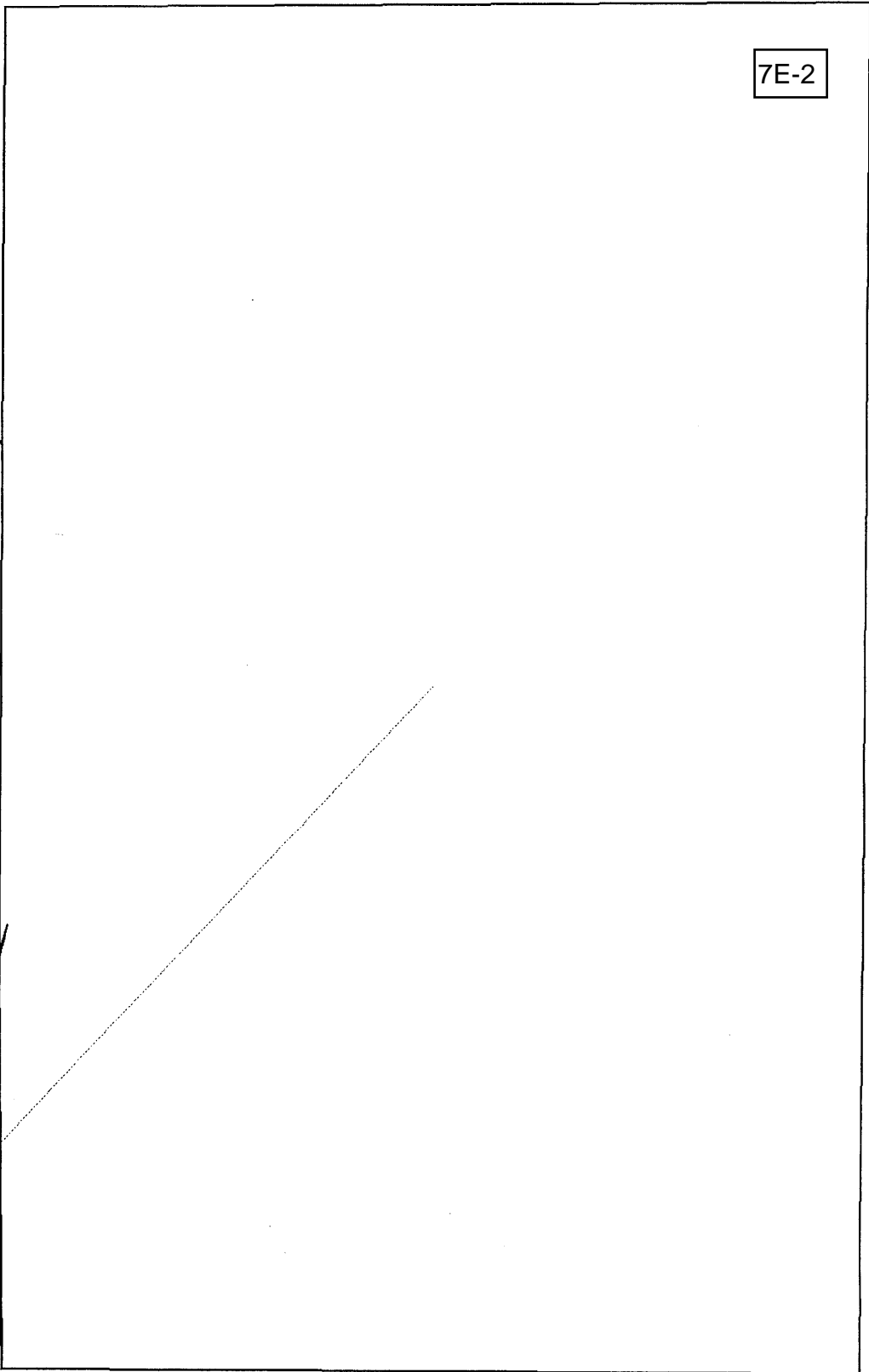

7E-2



Hemisphere Project Request Form APPALACHIA HIDTA

Please Fax When Complete

7E-1

HRC Fax : (b)(7)(A),(b)(7)(E)

HIGH INTENSITY DRUG TRAFFICKING AREA
Office of National Drug Control Policy

Master Case Number:	<input type="text"/>	Priority:	<input type="text"/>	Current Date:	<input type="text" value="2014-05-29 10:53:55"/>
HIDTA Point of Contac Name:		Email Results To:			
<input type="text"/>		<input type="text"/>			
POC Phone Number:		Email Notification Of Completion To:			
<input type="text"/>		<input type="text"/>			
Requestor Name:		Email Results To:			
<input type="text"/>		<input type="text"/>			
Requestor Phone Number:		Email Notification Of Completion To:			
<input type="text"/>		<input type="text"/>			
DTO Name (if applicable):			Case Name (if applicable):		
<input type="text"/>			<input type="text"/>		
HIDTA Initiative:	HIDTA Initiative OR Law Enforcement Agency:				
<input type="checkbox"/> Yes <input type="checkbox"/> No	<input type="text"/>				
Squad Name:		<input type="text"/>			
Time Zone Results Requested In:		<input type="text"/>			

(b)(7)(A),(b)(7)(E)

7E-2

Phone Number	Priority	Date Range	
<input type="text"/>	<input type="text"/>	<input type="text"/>	<input type="text"/>
<input type="text"/>	<input type="text"/>	<input type="text"/>	<input type="text"/>
<input type="text"/>	<input type="text"/>	<input type="text"/>	<input type="text"/>
<input type="text"/>	<input type="text"/>	<input type="text"/>	<input type="text"/>
<input type="text"/>	<input type="text"/>	<input type="text"/>	<input type="text"/>
<input type="text"/>	<input type="text"/>	<input type="text"/>	<input type="text"/>
<input type="text"/>	<input type="text"/>	<input type="text"/>	<input type="text"/>
<input type="text"/>	<input type="text"/>	<input type="text"/>	<input type="text"/>
<input type="text"/>	<input type="text"/>	<input type="text"/>	<input type="text"/>
<input type="text"/>	<input type="text"/>	<input type="text"/>	<input type="text"/>
<input type="text"/>	<input type="text"/>	<input type="text"/>	<input type="text"/>
<input type="text"/>	<input type="text"/>	<input type="text"/>	<input type="text"/>
<input type="text"/>	<input type="text"/>	<input type="text"/>	<input type="text"/>
<input type="text"/>	<input type="text"/>	<input type="text"/>	<input type="text"/>
<input type="text"/>	<input type="text"/>	<input type="text"/>	<input type="text"/>
<input type="text"/>	<input type="text"/>	<input type="text"/>	<input type="text"/>
<input type="text"/>	<input type="text"/>	<input type="text"/>	<input type="text"/>
<input type="text"/>	<input type="text"/>	<input type="text"/>	<input type="text"/>
<input type="text"/>	<input type="text"/>	<input type="text"/>	<input type="text"/>
<input type="text"/>	<input type="text"/>	<input type="text"/>	<input type="text"/>
<input type="text"/>	<input type="text"/>	<input type="text"/>	<input type="text"/>
<input type="text"/>	<input type="text"/>	<input type="text"/>	<input type="text"/>
<input type="text"/>	<input type="text"/>	<input type="text"/>	<input type="text"/>



Hemisphere Project Request Form ATLANTA HIDTA

Please Fax When Complete

7E-1

HRC Fax : (b)(7)(A),(b)(7)(E)

HIGH INTENSITY DRUG TRAFFICKING AREA
Office of National Drug Control Policy

Master Case Number:	<input type="text"/>	Priority:	<input type="text"/>	Current Date:	2014-05-29 10:54:10
HIDTA Point of Contac Name:		Email Results To:			
<input type="text"/>		<input type="text"/>			
POC Phone Number:		Email Notification Of Completion To:			
<input type="text"/>		<input type="text"/>			
Requestor Name:		Email Results To:			
<input type="text"/>		<input type="text"/>			
Requestor Phone Number:		Email Notification Of Completion To:			
<input type="text"/>		<input type="text"/>			
DTO Name (if applicable):			Case Name (if applicable):		
<input type="text"/>			<input type="text"/>		
HIDTA Initiative:	HIDTA Initiative OR Law Enforcement Agency:				
Yes <input type="checkbox"/> No <input type="checkbox"/>	<input type="text"/>				
Squad Name:		<input type="text"/>			
Time Zone Results Requested In:		<input type="text"/>			

(b)(7)(A),(b)(7)(E)

7E-2

Phone Number	Priority	Date Range	



Hemisphere Project Request Form CENTRAL FLORIDA HIDTA

Please Fax When Complete

7E-1

HRC Fax : (b)(7)(A), (b)(7)(E)

HIGH INTENSITY DRUG TRAFFICKING AREA
Office of National Drug Control Policy

Master Case Number:	<input type="text"/>	Priority:	<input type="text"/>	Current Date:	2014-05-29 10:54:25
HIDTA Point of Contac Name:		Email Results To:			
<input type="text"/>		<input type="text"/>			
POC Phone Number:		Email Notification Of Completion To:			
<input type="text"/>		<input type="text"/>			
Requestor Name:		Email Results To:			
<input type="text"/>		<input type="text"/>			
Requestor Phone Number:		Email Notification Of Completion To:			
<input type="text"/>		<input type="text"/>			
DTO Name (if applicable):			Case Name (if applicable):		
<input type="text"/>			<input type="text"/>		
HIDTA Initiative:	HIDTA Initiative OR Law Enforcement Agency:		<input type="text"/>		
Yes <input type="checkbox"/> No <input type="checkbox"/>	Squad Name:		<input type="text"/>		
Time Zone Results Requested In:		<input type="text"/>			

(b)(7)(A), (b)(7)(E)

7E-2

Phone Number	Priority	Date Range	
<input data-bbox="289 304 495 346" type="text"/>	<input data-bbox="553 304 883 346" type="text"/>	<input data-bbox="933 304 1082 346" type="text"/>	<input data-bbox="1123 304 1272 346" type="text"/>
<input data-bbox="289 388 495 430" type="text"/>	<input data-bbox="553 388 883 430" type="text"/>	<input data-bbox="933 388 1082 430" type="text"/>	<input data-bbox="1123 388 1272 430" type="text"/>
<input data-bbox="289 472 495 514" type="text"/>	<input data-bbox="553 472 883 514" type="text"/>	<input data-bbox="933 472 1082 514" type="text"/>	<input data-bbox="1123 472 1272 514" type="text"/>
<input data-bbox="289 556 495 598" type="text"/>	<input data-bbox="553 556 883 598" type="text"/>	<input data-bbox="933 556 1082 598" type="text"/>	<input data-bbox="1123 556 1272 598" type="text"/>
<input data-bbox="289 640 495 682" type="text"/>	<input data-bbox="553 640 883 682" type="text"/>	<input data-bbox="933 640 1082 682" type="text"/>	<input data-bbox="1123 640 1272 682" type="text"/>
<input data-bbox="289 724 495 766" type="text"/>	<input data-bbox="553 724 883 766" type="text"/>	<input data-bbox="933 724 1082 766" type="text"/>	<input data-bbox="1123 724 1272 766" type="text"/>
<input data-bbox="289 808 495 850" type="text"/>	<input data-bbox="553 808 883 850" type="text"/>	<input data-bbox="933 808 1082 850" type="text"/>	<input data-bbox="1123 808 1272 850" type="text"/>
<input data-bbox="289 892 495 934" type="text"/>	<input data-bbox="553 892 883 934" type="text"/>	<input data-bbox="933 892 1082 934" type="text"/>	<input data-bbox="1123 892 1272 934" type="text"/>
<input data-bbox="289 976 495 1018" type="text"/>	<input data-bbox="553 976 883 1018" type="text"/>	<input data-bbox="933 976 1082 1018" type="text"/>	<input data-bbox="1123 976 1272 1018" type="text"/>
<input data-bbox="289 1060 495 1102" type="text"/>	<input data-bbox="553 1060 883 1102" type="text"/>	<input data-bbox="933 1060 1082 1102" type="text"/>	<input data-bbox="1123 1060 1272 1102" type="text"/>
<input data-bbox="289 1144 495 1186" type="text"/>	<input data-bbox="553 1144 883 1186" type="text"/>	<input data-bbox="933 1144 1082 1186" type="text"/>	<input data-bbox="1123 1144 1272 1186" type="text"/>
<input data-bbox="289 1228 495 1270" type="text"/>	<input data-bbox="553 1228 883 1270" type="text"/>	<input data-bbox="933 1228 1082 1270" type="text"/>	<input data-bbox="1123 1228 1272 1270" type="text"/>
<input data-bbox="289 1312 495 1354" type="text"/>	<input data-bbox="553 1312 883 1354" type="text"/>	<input data-bbox="933 1312 1082 1354" type="text"/>	<input data-bbox="1123 1312 1272 1354" type="text"/>
<input data-bbox="289 1396 495 1438" type="text"/>	<input data-bbox="553 1396 883 1438" type="text"/>	<input data-bbox="933 1396 1082 1438" type="text"/>	<input data-bbox="1123 1396 1272 1438" type="text"/>
<input data-bbox="289 1480 495 1522" type="text"/>	<input data-bbox="553 1480 883 1522" type="text"/>	<input data-bbox="933 1480 1082 1522" type="text"/>	<input data-bbox="1123 1480 1272 1522" type="text"/>
<input data-bbox="289 1564 495 1606" type="text"/>	<input data-bbox="553 1564 883 1606" type="text"/>	<input data-bbox="933 1564 1082 1606" type="text"/>	<input data-bbox="1123 1564 1272 1606" type="text"/>
<input data-bbox="289 1648 495 1690" type="text"/>	<input data-bbox="553 1648 883 1690" type="text"/>	<input data-bbox="933 1648 1082 1690" type="text"/>	<input data-bbox="1123 1648 1272 1690" type="text"/>
<input data-bbox="289 1732 495 1774" type="text"/>	<input data-bbox="553 1732 883 1774" type="text"/>	<input data-bbox="933 1732 1082 1774" type="text"/>	<input data-bbox="1123 1732 1272 1774" type="text"/>
<input data-bbox="289 1816 495 1858" type="text"/>	<input data-bbox="553 1816 883 1858" type="text"/>	<input data-bbox="933 1816 1082 1858" type="text"/>	<input data-bbox="1123 1816 1272 1858" type="text"/>
<input data-bbox="289 1900 495 1942" type="text"/>	<input data-bbox="553 1900 883 1942" type="text"/>	<input data-bbox="933 1900 1082 1942" type="text"/>	<input data-bbox="1123 1900 1272 1942" type="text"/>
<input data-bbox="289 1984 495 2026" type="text"/>	<input data-bbox="553 1984 883 2026" type="text"/>	<input data-bbox="933 1984 1082 2026" type="text"/>	<input data-bbox="1123 1984 1272 2026" type="text"/>



HIGH INTENSITY DRUG TRAFFICKING AREA
Office of National Drug Control Policy

Hemisphere Project Request Form LAKE COUNTY HIDTA

Please Fax When Complete

7E-1

HRC Fax : (b)(7)(A), (b)(7)(E)

Master Case Number:	<input type="text"/>	Priority:	<input type="text"/>	Current Date:	2014-05-29 10:54:37
HIDTA Point of Contact Name:		Email Results To:			
<input type="text"/>		<input type="text"/>			
POC Phone Number:		Email Notification Of Completion To:			
<input type="text"/>		<input type="text"/>			
Requestor Name:		Email Results To:			
<input type="text"/>		<input type="text"/>			
Requestor Phone Number:		Email Notification Of Completion To:			
<input type="text"/>		<input type="text"/>			
DTO Name (if applicable):			Case Name (if applicable):		
<input type="text"/>			<input type="text"/>		
HIDTA Initiative:	HIDTA Initiative OR Law Enforcement Agency:				
Yes <input type="checkbox"/> No <input type="checkbox"/>	<input type="text"/>				
Squad Name:		<input type="text"/>			
Time Zone Results Requested In:		<input type="text"/>			

(b)(7)(A), (b)(7)(E)

7E-2

Phone Number	Priority	Date Range	



Hemisphere Project Request Form MICHIGAN HIDTA

Please Fax When Complete

7E-1

HRC Fax : (b)(7)(A),(b)(7)(E)

HIGH INTENSITY DRUG TRAFFICKING AREA
Office of National Drug Control Policy

Master Case Number:	<input type="text"/>	Priority:	<input type="text"/>	Current Date:	<input type="text" value="2014-05-29 10:54:50"/>
HIDTA Point of Contac Name:		Email Results To:			
<input type="text"/>		<input type="text"/>			
POC Phone Number:		Email Notification Of Completion To:			
<input type="text"/>		<input type="text"/>			
Requestor Name:		Email Results To:			
<input type="text"/>		<input type="text"/>			
Requestor Phone Number:		Email Notification Of Completion To:			
<input type="text"/>		<input type="text"/>			
DTO Name (if applicable):			Case Name (if applicable):		
<input type="text"/>			<input type="text"/>		
HIDTA Initiative:	HIDTA Initiative OR Law Enforcement Agency:				
Yes <input type="checkbox"/> No <input type="checkbox"/>	<input type="text"/>				
Squad Name:		<input type="text"/>			
Time Zone Results Requested In:		<input type="text"/>			

(b)(7)(A) (b)(7)(E)

7E-2

Phone Number	Priority	Date Range	
<input type="text"/>	<input type="text"/>	<input type="text"/>	<input type="text"/>
<input type="text"/>	<input type="text"/>	<input type="text"/>	<input type="text"/>
<input type="text"/>	<input type="text"/>	<input type="text"/>	<input type="text"/>
<input type="text"/>	<input type="text"/>	<input type="text"/>	<input type="text"/>
<input type="text"/>	<input type="text"/>	<input type="text"/>	<input type="text"/>
<input type="text"/>	<input type="text"/>	<input type="text"/>	<input type="text"/>
<input type="text"/>	<input type="text"/>	<input type="text"/>	<input type="text"/>
<input type="text"/>	<input type="text"/>	<input type="text"/>	<input type="text"/>
<input type="text"/>	<input type="text"/>	<input type="text"/>	<input type="text"/>
<input type="text"/>	<input type="text"/>	<input type="text"/>	<input type="text"/>
<input type="text"/>	<input type="text"/>	<input type="text"/>	<input type="text"/>
<input type="text"/>	<input type="text"/>	<input type="text"/>	<input type="text"/>
<input type="text"/>	<input type="text"/>	<input type="text"/>	<input type="text"/>
<input type="text"/>	<input type="text"/>	<input type="text"/>	<input type="text"/>
<input type="text"/>	<input type="text"/>	<input type="text"/>	<input type="text"/>
<input type="text"/>	<input type="text"/>	<input type="text"/>	<input type="text"/>
<input type="text"/>	<input type="text"/>	<input type="text"/>	<input type="text"/>
<input type="text"/>	<input type="text"/>	<input type="text"/>	<input type="text"/>
<input type="text"/>	<input type="text"/>	<input type="text"/>	<input type="text"/>
<input type="text"/>	<input type="text"/>	<input type="text"/>	<input type="text"/>
<input type="text"/>	<input type="text"/>	<input type="text"/>	<input type="text"/>
<input type="text"/>	<input type="text"/>	<input type="text"/>	<input type="text"/>
<input type="text"/>	<input type="text"/>	<input type="text"/>	<input type="text"/>
<input type="text"/>	<input type="text"/>	<input type="text"/>	<input type="text"/>
<input type="text"/>	<input type="text"/>	<input type="text"/>	<input type="text"/>
<input type="text"/>	<input type="text"/>	<input type="text"/>	<input type="text"/>



Hemisphere Project Request Form NEW ENGLAND HIDTA

Please Fax When Complete

7E-1

HRC Fax : (b)(7)(A), (b)(7)(E)

HIGH INTENSITY DRUG TRAFFICKING AREA
Office of National Drug Control Policy

Master Case Number:	<input type="text"/>	Priority:	<input type="text"/>	Current Date:	2014-05-29 10:55:03
HIDTA Point of Contact Name:		Email Results To:			
<input type="text"/>		<input type="text"/>			
POC Phone Number:		Email Notification Of Completion To:			
<input type="text"/>		<input type="text"/>			
Requestor Name:		Email Results To:			
<input type="text"/>		<input type="text"/>			
Requestor Phone Number:		Email Notification Of Completion To:			
<input type="text"/>		<input type="text"/>			
DTO Name (if applicable):			Case Name (if applicable):		
<input type="text"/>			<input type="text"/>		
HIDTA Initiative:	HIDTA Initiative OR Law Enforcement Agency:				
<input type="checkbox"/> Yes <input type="checkbox"/> No	<input type="text"/>				
Squad Name:		<input type="text"/>			
Time Zone Results Requested In:		<input type="text"/>			

(b)(7)(A), (b)(7)(E)

7E-2

Phone Number	Priority	Date Range	



Hemisphere Project Request Form

Please Fax When Complete

7E-1

HIGH INTENSITY DRUG TRAFFICKING AREA
Office of National Drug Control Policy

HRC Fax (b)(7)(A),(b)(7)(E)

NEW YORK/NEW JERSEY HIDTA

Master Case Number:	<input type="text"/>	Priority:	<input type="text"/>	Current Date:	2014-05-29 10:55:20
HIDTA Point of Contact Name:		Email Results To:			
<input type="text"/>		<input type="text"/>			
POC Phone Number:		Email Notification Of Completion To:			
<input type="text"/>		<input type="text"/>			
Requestor Name:		Email Results To:			
<input type="text"/>		<input type="text"/>			
Requestor Phone Number:		Email Notification Of Completion To:			
<input type="text"/>		<input type="text"/>			
DTO Name (if applicable):			Case Name (if applicable):		
<input type="text"/>			<input type="text"/>		
HIDTA Initiative:	HIDTA Initiative OR Law Enforcement Agency:				
Yes <input type="checkbox"/> No <input type="checkbox"/>	<input type="text"/>				
Squad Name:		<input type="text"/>			
Time Zone Results Requested in:		<input type="text"/>			

(b)(7)(A) (b)(7)(E)

7E-2



Hemisphere Project Request Form NORTH FLORIDA HIDTA

Please Fax When Complete **7E-1**

HRC Fax: (b)(7)(A), (b)(7)(E)

HIGH INTENSITY DRUG TRAFFICKING AREA
Office of National Drug Control Policy

Master Case Number:	<input type="text"/>	Priority:	<input type="text"/>	Current Date:	2014-05-29 10:55:32
HIDTA Point of Contac Name:		Email Results To:			
<input type="text"/>		<input type="text"/>			
POC Phone Number:		Email Notification Of Completion To:			
<input type="text"/>		<input type="text"/>			
Requestor Name:		Email Results To:			
<input type="text"/>		<input type="text"/>			
Requestor Phone Number:		Email Notification Of Completion To:			
<input type="text"/>		<input type="text"/>			
DTO Name (if appliccable):			Case Name (if appliccable):		
<input type="text"/>			<input type="text"/>		
HIDTA Initiative:	HIDTA Initiative OR Law Enforcement Agency:	<input type="text"/>			
Yes <input type="checkbox"/> No <input type="checkbox"/>	Squad Name:	<input type="text"/>			
Time Zone Results Requested In:	<input type="text"/>				

(b)(7)(A) (b)(7)(E)

7E-2

Phone Number	Priority	Date Range	



Hemisphere Project Request Form OHIO HIDTA

Please Fax When Complete

7E-1

HRC Fax: (b)(7)(A), (b)(7)(E)

HIGH INTENSITY DRUG TRAFFICKING AREA
Office of National Drug Control Policy

Master Case Number: Priority: Current Date:

HIDTA Point of Contact Name: Email Results To:
 POC Phone Number: Email Notification Of Completion To:

Requestor Name: Email Results To:
 Requestor Phone Number: Email Notification Of Completion To:

DTO Name (if applicable): Case Name (if applicable):

HIDTA Initiative: Yes No HIDTA Initiative OR Law Enforcement Agency:
 Squad Name:
 Time Zone Results Requested In:

(b)(7)(A) (b)(7)(E)

7E-2

Phone Number	Priority	Date Range	



Hemisphere Project Request Form

Please Fax When Complete

7E-1

HRC Fax (b)(7)(A),(b)(7)(E)

HIGH INTENSITY DRUG TRAFFICKING AREA
Office of National Drug Control Policy

PHILADELPHIA/CAMDEN HIDTA

Master Case Number: [] Priority: [] Current Date: 2014-05-29 10:55:55

HIDTA Point of Contact Name: [] Email Results To: []

POC Phone Number: [] Email Notification Of Completion To: []

Requestor Name: [] Email Results To: []

Requestor Phone Number: [] Email Notification Of Completion To: []

DTO Name (if applicable): [] Case Name (if applicable): []

HIDTA Initiative: Yes No HIDTA Initiative OR Law Enforcement Agency: []

Squad Name: []

Time Zone Results Requested In: []

(b)(7)(A), (b)(7)(E)

7E-2

Phone Number	Priority	Date Range	



Hemisphere Project Request Form

Please Fax When Complete

7E-1

HRC Fax: (b)(7)(A),(b)(7)(E)

HIGH INTENSITY DRUG TRAFFICKING AREA
Office of National Drug Control Policy

PUERTO RICO/VIRGIN IS. HIDTA

Master Case Number:	<input type="text"/>	Priority:	<input type="text"/>	Current Date:	2014-05-29 10:56:07
HIDTA Point of Contact Name:		Email Results To:			
<input type="text"/>		<input type="text"/>			
POC Phone Number:		Email Notification Of Completion To:			
<input type="text"/>		<input type="text"/>			
Requestor Name:		Email Results To:			
<input type="text"/>		<input type="text"/>			
Requestor Phone Number:		Email Notification Of Completion To:			
<input type="text"/>		<input type="text"/>			
DTO Name (if applicable):			Case Name (if applicable):		
<input type="text"/>			<input type="text"/>		
HIDTA Initiative:	HIDTA Initiative OR Law Enforcement Agency:				
Yes <input type="checkbox"/> No <input type="checkbox"/>	<input type="text"/>				
Squad Name:		<input type="text"/>			
Time Zone Results Requested In:		<input type="text"/>			

(b)(7)(A),(b)(7)(E)

7E-2

Phone Number	Priority	Date Range	
<input data-bbox="294 302 505 352" type="text"/>	<input data-bbox="558 302 892 352" type="text"/>	<input data-bbox="938 310 1083 361" type="text"/>	<input data-bbox="1129 310 1275 361" type="text"/>
<input data-bbox="294 394 505 445" type="text"/>	<input data-bbox="558 394 892 445" type="text"/>	<input data-bbox="938 403 1083 453" type="text"/>	<input data-bbox="1129 403 1275 453" type="text"/>
<input data-bbox="294 487 505 537" type="text"/>	<input data-bbox="558 487 892 537" type="text"/>	<input data-bbox="938 495 1083 546" type="text"/>	<input data-bbox="1129 495 1275 546" type="text"/>
<input data-bbox="294 579 505 630" type="text"/>	<input data-bbox="558 579 892 630" type="text"/>	<input data-bbox="938 588 1083 638" type="text"/>	<input data-bbox="1129 588 1275 638" type="text"/>
<input data-bbox="294 672 505 722" type="text"/>	<input data-bbox="558 672 892 722" type="text"/>	<input data-bbox="938 680 1083 730" type="text"/>	<input data-bbox="1129 680 1275 730" type="text"/>
<input data-bbox="294 764 505 814" type="text"/>	<input data-bbox="558 764 892 814" type="text"/>	<input data-bbox="938 772 1083 823" type="text"/>	<input data-bbox="1129 772 1275 823" type="text"/>
<input data-bbox="294 856 505 907" type="text"/>	<input data-bbox="558 856 892 907" type="text"/>	<input data-bbox="938 865 1083 915" type="text"/>	<input data-bbox="1129 865 1275 915" type="text"/>
<input data-bbox="294 949 505 999" type="text"/>	<input data-bbox="558 949 892 999" type="text"/>	<input data-bbox="938 957 1083 1008" type="text"/>	<input data-bbox="1129 957 1275 1008" type="text"/>
<input data-bbox="294 1041 505 1092" type="text"/>	<input data-bbox="558 1041 892 1092" type="text"/>	<input data-bbox="938 1050 1083 1100" type="text"/>	<input data-bbox="1129 1050 1275 1100" type="text"/>
<input data-bbox="294 1134 505 1184" type="text"/>	<input data-bbox="558 1134 892 1184" type="text"/>	<input data-bbox="938 1142 1083 1192" type="text"/>	<input data-bbox="1129 1142 1275 1192" type="text"/>
<input data-bbox="294 1226 505 1276" type="text"/>	<input data-bbox="558 1226 892 1276" type="text"/>	<input data-bbox="938 1234 1083 1285" type="text"/>	<input data-bbox="1129 1234 1275 1285" type="text"/>
<input data-bbox="294 1318 505 1369" type="text"/>	<input data-bbox="558 1318 892 1369" type="text"/>	<input data-bbox="938 1327 1083 1377" type="text"/>	<input data-bbox="1129 1327 1275 1377" type="text"/>
<input data-bbox="294 1411 505 1461" type="text"/>	<input data-bbox="558 1411 892 1461" type="text"/>	<input data-bbox="938 1419 1083 1470" type="text"/>	<input data-bbox="1129 1419 1275 1470" type="text"/>
<input data-bbox="294 1503 505 1554" type="text"/>	<input data-bbox="558 1503 892 1554" type="text"/>	<input data-bbox="938 1512 1083 1562" type="text"/>	<input data-bbox="1129 1512 1275 1562" type="text"/>
<input data-bbox="294 1596 505 1646" type="text"/>	<input data-bbox="558 1596 892 1646" type="text"/>	<input data-bbox="938 1604 1083 1654" type="text"/>	<input data-bbox="1129 1604 1275 1654" type="text"/>
<input data-bbox="294 1688 505 1738" type="text"/>	<input data-bbox="558 1688 892 1738" type="text"/>	<input data-bbox="938 1696 1083 1747" type="text"/>	<input data-bbox="1129 1696 1275 1747" type="text"/>
<input data-bbox="294 1780 505 1831" type="text"/>	<input data-bbox="558 1780 892 1831" type="text"/>	<input data-bbox="938 1789 1083 1839" type="text"/>	<input data-bbox="1129 1789 1275 1839" type="text"/>
<input data-bbox="294 1873 505 1923" type="text"/>	<input data-bbox="558 1873 892 1923" type="text"/>	<input data-bbox="938 1881 1083 1932" type="text"/>	<input data-bbox="1129 1881 1275 1932" type="text"/>
<input data-bbox="294 1965 505 2016" type="text"/>	<input data-bbox="558 1965 892 2016" type="text"/>	<input data-bbox="938 1974 1083 2024" type="text"/>	<input data-bbox="1129 1974 1275 2024" type="text"/>



Hemisphere Project Request Form SOUTH FLORIDA HIDTA

Please Fax When Complete

South Florida ISC Fax: 7E-1

HIGH INTENSITY DRUG TRAFFICKING AREA
Office of National Drug Control Policy

(b)(7)(A),(b)(7)(E)

Master Case Number: Priority: Current Date:

HIDTA Point of Contact Name: Email Results To:

POC Phone Number: Email Notification Of Completion To:

Requestor Name: Email Results To:

Requestor Phone Number: Email Notification Of Completion To:

DTO Name (if applicable): Case Name (if applicable):

HIDTA Initiative: HIDTA Initiative OR Law Enforcement Agency:

Yes No Squad Name:

Time Zone Results Requested in:

(b)(7)(A) (b)(7)(E)

7E-2



Hemisphere Project Request Form

Please Fax When Complete

7E-1

HRC Fax: (b)(7)(A), (b)(7)(E)

HIGH INTENSITY DRUG TRAFFICKING AREA
Office of National Drug Control Policy

WASHINGTON/BALTIMORE HIDTA

Master Case Number: Priority: Current Date: 2014-05-29 10:56:31

HIDTA Point of Contac Name: Email Results To:

POC Phone Number:

Email Notification Of Completion To:

Requestor Name:

Email Results To:

Requestor Phone Number:

Email Notification Of Completion To:

DTO Name (if applicable):

Case Name (if applicable):

HIDTA Initiative: Yes No

HIDTA Initiative OR Law Enforcement Agency:

Squad Name:

Time Zone Results Requested in:

(b)(7)(A) (b)(7)(E)

7E-2

Hemisphere and Privacy

- Hemisphere is subpoena/court order driven access to business records (court order required to [redacted])
- Records are held by the telecommunications provider as their routine business records and are not directly available to investigators and supporting case analysts except those subject to legal process

[redacted]

Law Enforcement Sensitive

(b)(7)(A), (b)(7)(E)

7E-3

7E-2

• Federal courts have consistently held to the Third Party rule

Hemisphere and Privacy

(b)(7)(A), (b)(7)(E)

7E-3

7E-2

Law Enforcement Sensitive



HIGH INTENSITY DRUG TRAFFICKING AREA
Office of National Drug Control Policy

Hemisphere Project Request Form HOUSTON HIDTA

Please Fax When Complete

7E-1

HRC Fax : (b)(7)(A), (b)(7)(E)

Master Case Number:	<input type="text"/>	Priority:	<input type="text"/>	Current Date:	2013-12-02 09:32:52
HIDTA Point of Contact Name:		Email Results To:			
<input type="text"/>		<input type="text"/>			
POC Phone Number:		Email Notification Of Completion To:			
<input type="text"/>		<input type="text"/>			
Requestor Name:		Email Results To:			
<input type="text"/>		<input type="text"/>			
Requestor Phone Number:		Email Notification Of Completion To:			
<input type="text"/>		<input type="text"/>			
DTO Name (if applicable):			Case Name (if applicable):		
<input type="text"/>			<input type="text"/>		
HIDTA Initiative:	HIDTA Initiative OR Law Enforcement Agency:				
Yes <input type="checkbox"/> No <input type="checkbox"/>	<input type="text"/>				
Squad Name:		<input type="text"/>			
Time Zone Results Requested in:		<input type="text"/>			

(b)(7)(A) (b)(7)(E)

7E-2

Phone Number	Priority	Date Range	
<input type="text"/>	<input type="text"/>	<input type="text"/>	<input type="text"/>
<input type="text"/>	<input type="text"/>	<input type="text"/>	<input type="text"/>
<input type="text"/>	<input type="text"/>	<input type="text"/>	<input type="text"/>
<input type="text"/>	<input type="text"/>	<input type="text"/>	<input type="text"/>
<input type="text"/>	<input type="text"/>	<input type="text"/>	<input type="text"/>
<input type="text"/>	<input type="text"/>	<input type="text"/>	<input type="text"/>
<input type="text"/>	<input type="text"/>	<input type="text"/>	<input type="text"/>
<input type="text"/>	<input type="text"/>	<input type="text"/>	<input type="text"/>
<input type="text"/>	<input type="text"/>	<input type="text"/>	<input type="text"/>
<input type="text"/>	<input type="text"/>	<input type="text"/>	<input type="text"/>
<input type="text"/>	<input type="text"/>	<input type="text"/>	<input type="text"/>
<input type="text"/>	<input type="text"/>	<input type="text"/>	<input type="text"/>
<input type="text"/>	<input type="text"/>	<input type="text"/>	<input type="text"/>
<input type="text"/>	<input type="text"/>	<input type="text"/>	<input type="text"/>
<input type="text"/>	<input type="text"/>	<input type="text"/>	<input type="text"/>
<input type="text"/>	<input type="text"/>	<input type="text"/>	<input type="text"/>
<input type="text"/>	<input type="text"/>	<input type="text"/>	<input type="text"/>
<input type="text"/>	<input type="text"/>	<input type="text"/>	<input type="text"/>
<input type="text"/>	<input type="text"/>	<input type="text"/>	<input type="text"/>
<input type="text"/>	<input type="text"/>	<input type="text"/>	<input type="text"/>
<input type="text"/>	<input type="text"/>	<input type="text"/>	<input type="text"/>

(b)(7)(A), (b)(7)(D), (b)(7)(E), (b)(7)(F)



HEMISPHERE SUBPOENA-

Official Language

All Hemisphere subpoenas should have the following in the recipient / address section...

7E-2

7D-1, 7E-6

(b)(7)(A), (b)(7)
(E)



HEMISPHERE SUBPOENA-
Official Language

7E-2



HOUSTON HIDTA
HIGH INTENSITY DRUG TRAFFICKING AREA
Office of National Drug Control Policy

Hemisphere Project Request Form

Please Fax When Complete

7E-1

HISC Fax : (b)(7)(A), (b)(7)(E)

Master Case Number: Sub-Case Number: Date/Time:

DTO Name (if applicable): Case Name (if applicable):

HIDTA Initiative: Yes No HIDTA Initiative OR Law Enforcement Agency:
Squad Name:

From: Secure Phone Number: Priority:

To: Deliver Results To:

Email Address:

(b)(7)(A), (b)(7)(E)

7E-2

Phone Number	Previous Tasking Info	Priority	Date Range	
<input type="text"/>	<input type="checkbox"/>	<input type="text"/>	<input type="text"/>	<input type="text"/>
<input type="text"/>	<input type="checkbox"/>	<input type="text"/>	<input type="text"/>	<input type="text"/>
<input type="text"/>	<input type="checkbox"/>	<input type="text"/>	<input type="text"/>	<input type="text"/>
<input type="text"/>	<input type="checkbox"/>	<input type="text"/>	<input type="text"/>	<input type="text"/>
<input type="text"/>	<input type="checkbox"/>	<input type="text"/>	<input type="text"/>	<input type="text"/>
<input type="text"/>	<input type="checkbox"/>	<input type="text"/>	<input type="text"/>	<input type="text"/>
<input type="text"/>	<input type="checkbox"/>	<input type="text"/>	<input type="text"/>	<input type="text"/>
<input type="text"/>	<input type="checkbox"/>	<input type="text"/>	<input type="text"/>	<input type="text"/>
<input type="text"/>	<input type="checkbox"/>	<input type="text"/>	<input type="text"/>	<input type="text"/>
<input type="text"/>	<input type="checkbox"/>	<input type="text"/>	<input type="text"/>	<input type="text"/>
<input type="text"/>	<input type="checkbox"/>	<input type="text"/>	<input type="text"/>	<input type="text"/>
<input type="text"/>	<input type="checkbox"/>	<input type="text"/>	<input type="text"/>	<input type="text"/>
<input type="text"/>	<input type="checkbox"/>	<input type="text"/>	<input type="text"/>	<input type="text"/>
<input type="text"/>	<input type="checkbox"/>	<input type="text"/>	<input type="text"/>	<input type="text"/>
<input type="text"/>	<input type="checkbox"/>	<input type="text"/>	<input type="text"/>	<input type="text"/>
<input type="text"/>	<input type="checkbox"/>	<input type="text"/>	<input type="text"/>	<input type="text"/>
<input type="text"/>	<input type="checkbox"/>	<input type="text"/>	<input type="text"/>	<input type="text"/>
<input type="text"/>	<input type="checkbox"/>	<input type="text"/>	<input type="text"/>	<input type="text"/>
<input type="text"/>	<input type="checkbox"/>	<input type="text"/>	<input type="text"/>	<input type="text"/>
<input type="text"/>	<input type="checkbox"/>	<input type="text"/>	<input type="text"/>	<input type="text"/>
<input type="text"/>	<input type="checkbox"/>	<input type="text"/>	<input type="text"/>	<input type="text"/>

(b)(6),(b)(7)(A),(b)(7)(C),(b)(7)(D),(b)(7)(E),(b)(7)(F)

PAGE 01/04

[Redacted]

U.S. DEPARTMENT OF JUSTICE / DRUG ENFORCEMENT ADMINISTRATION
SUBPOENA
In the matter of the investigation of

7D-1, 7E-6

7E-2

[Redacted]

[Redacted]

[Redacted]

6-1, 7C-1, 7E-8, 7F-1

[Redacted]

7E-2

7E-3

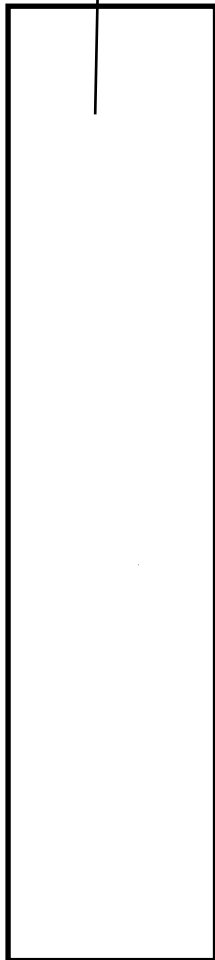

(b)(6), (b)(7)(A), (b)(7)(C), (b)(7)(D), (b)(7)(E), (b)(7)(F)

(b)(5),(b)(7)(A),(b)(7)(D),(b)(7)(E),(b)(7)(F)

5-1

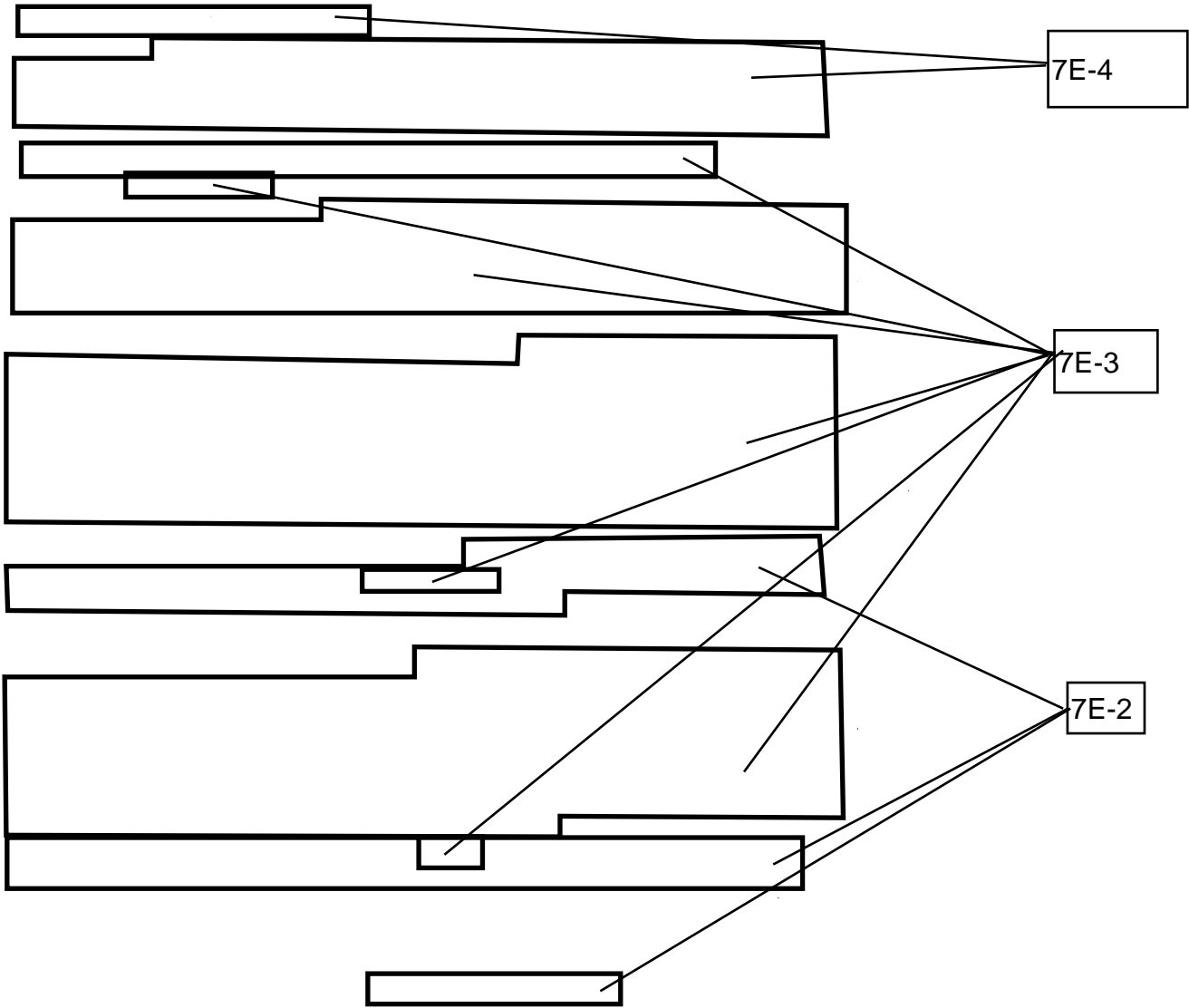

(b)(5),(b)(7)(A),(b)(7)(D),(b)(7)(E),(b)(7)(F)

5-1

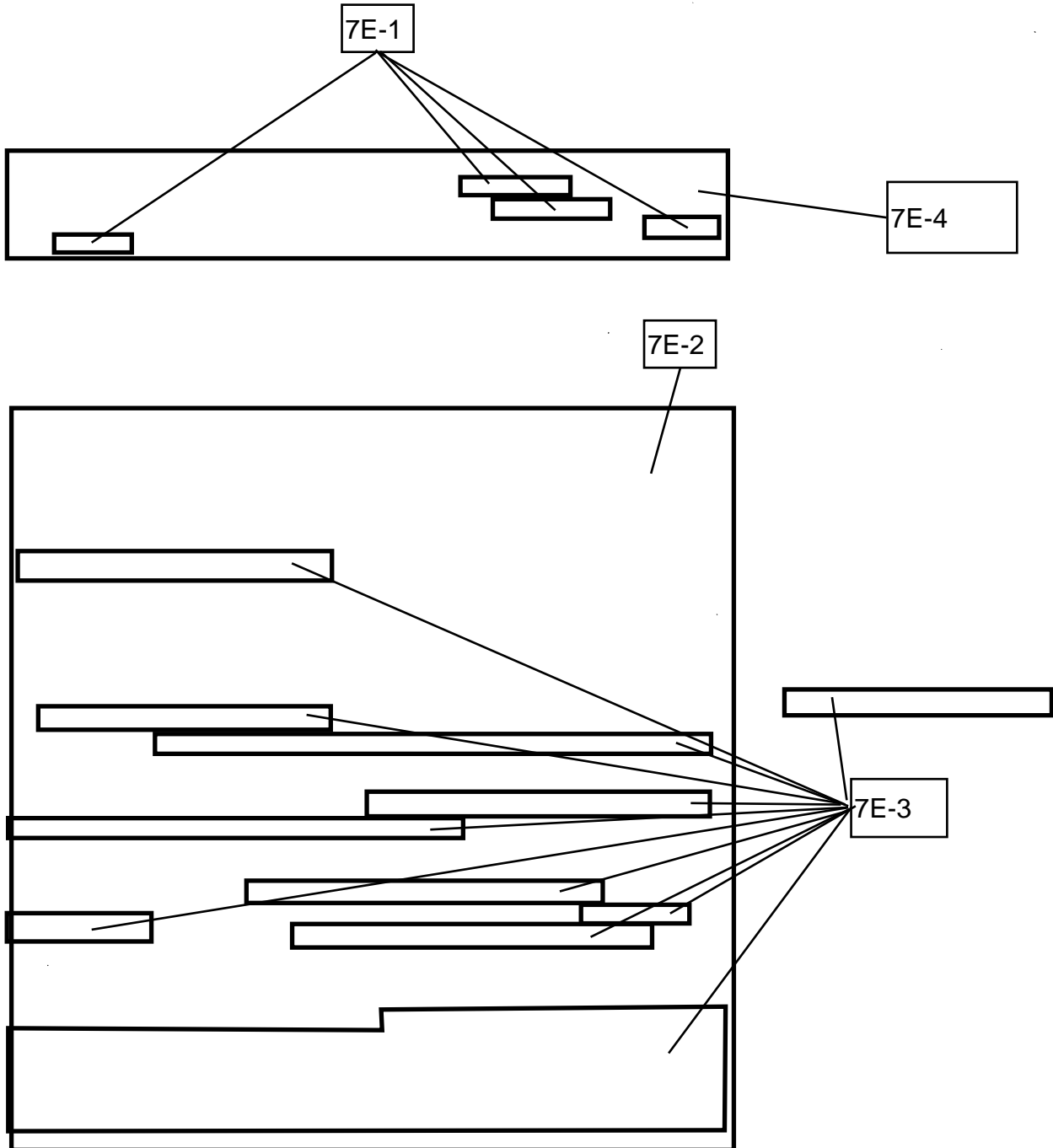

(b)(5),(b)(6),(b)(7)(A),(b)(7)(C),(b)(7)(D),(b)(7)(E),(b)(7)(F)

5-1

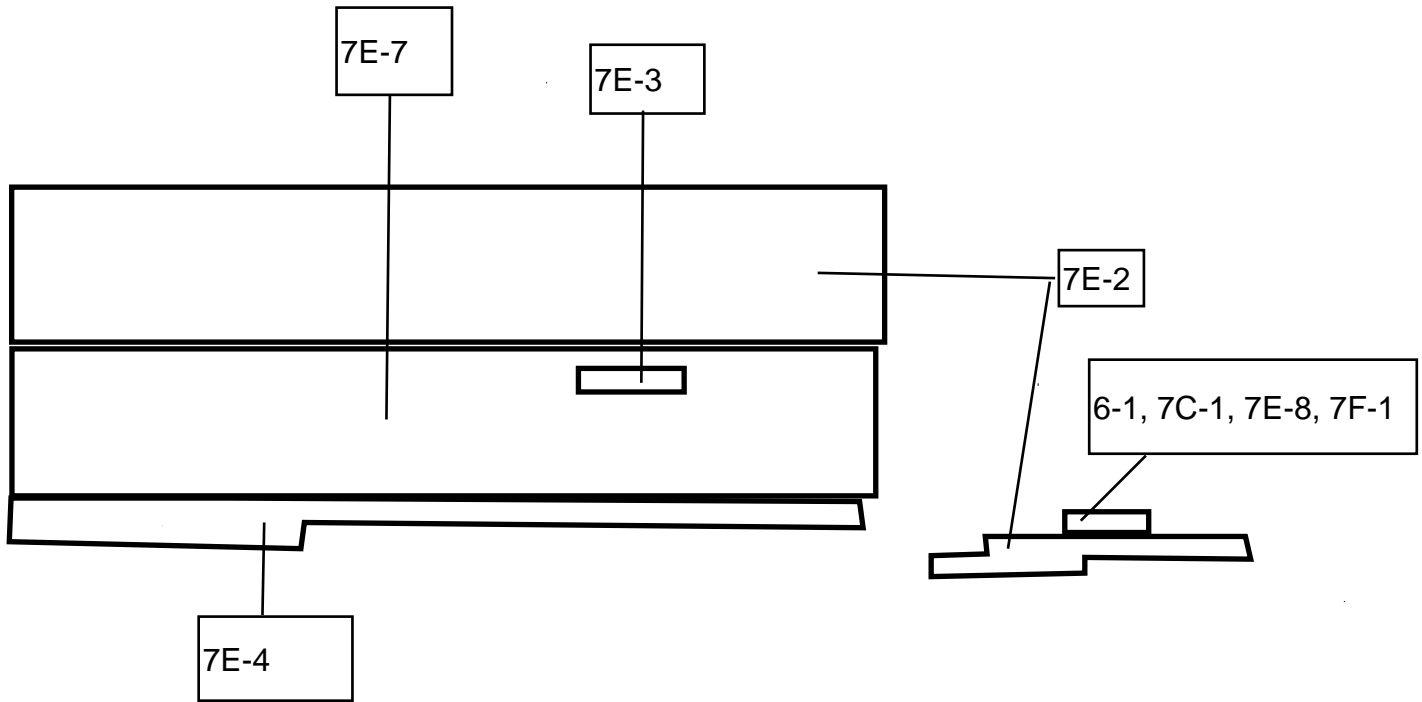

(b)(5),(b)(7)(A),(b)(7)(C),(b)(7)(D),(b)(7)(E),(b)(7)(F)

5-1

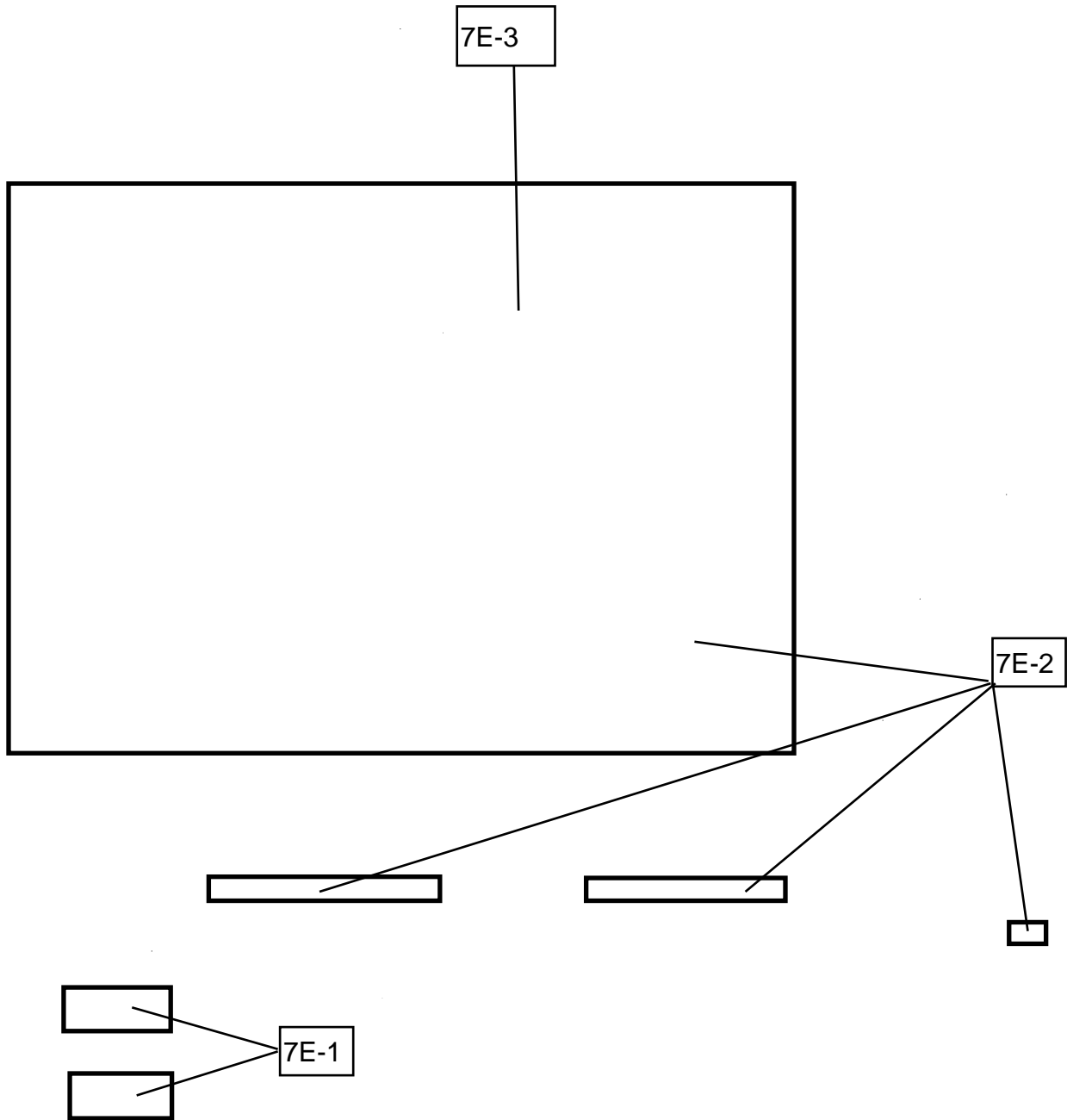

(b)(5), (b)(7)(A), (b)(7)(C), (b)(7)(D), (b)(7)(E), (b)(7)(F)

5-1

7E-1

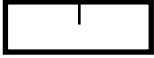

7E-5



7E-2



7E-7

7E-3

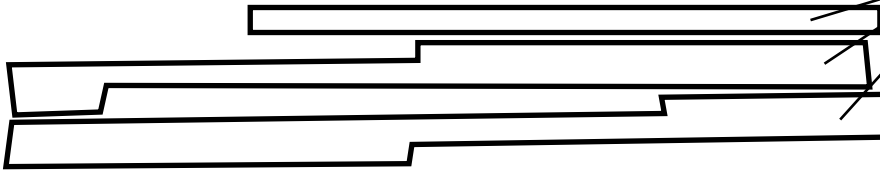

(b)(5),(b)(7)(A),(b)(7)(D),(b)(7)(E)

5-1

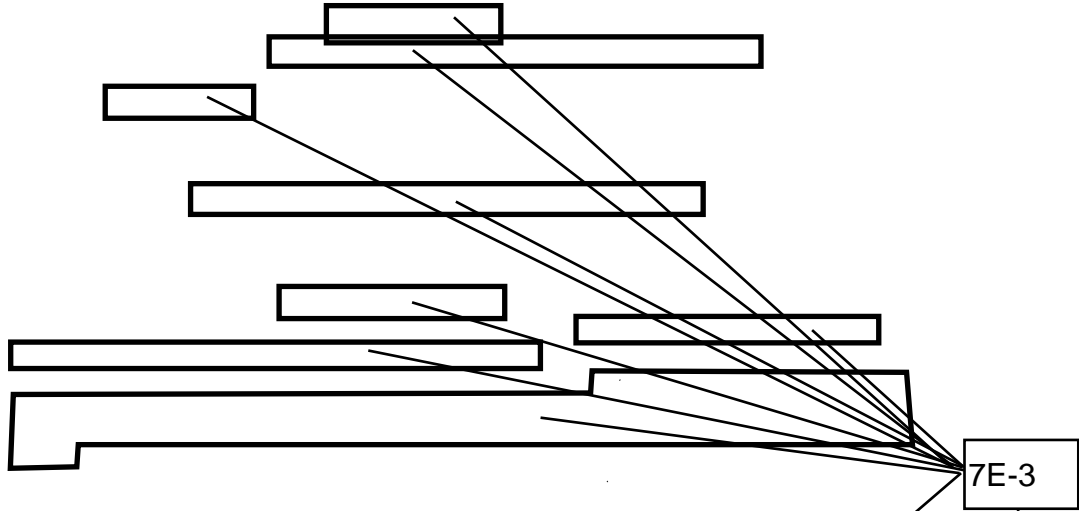

7E-2

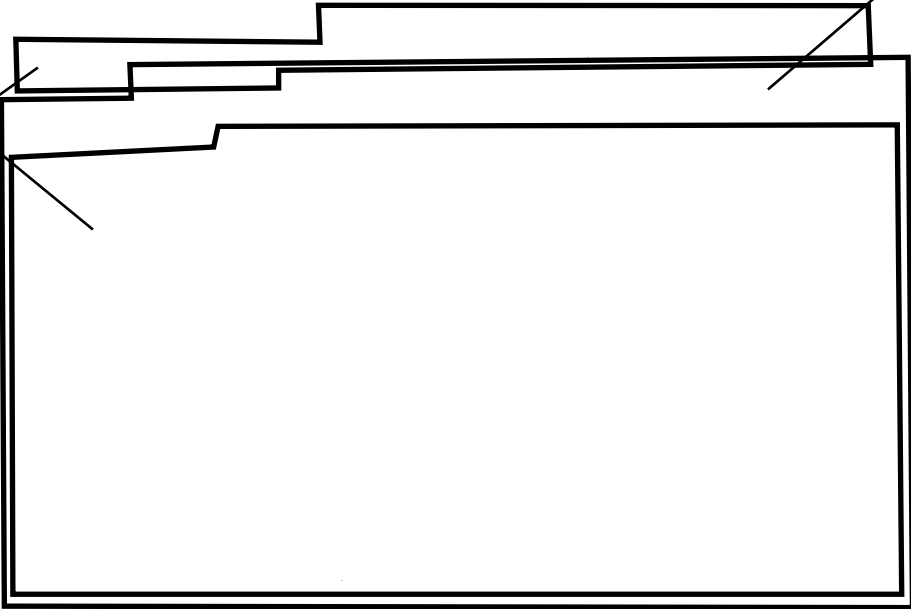

7E-3



(b)(5),(b)(7)(A),(b)(7)(D),(b)(7)(E)

5-1

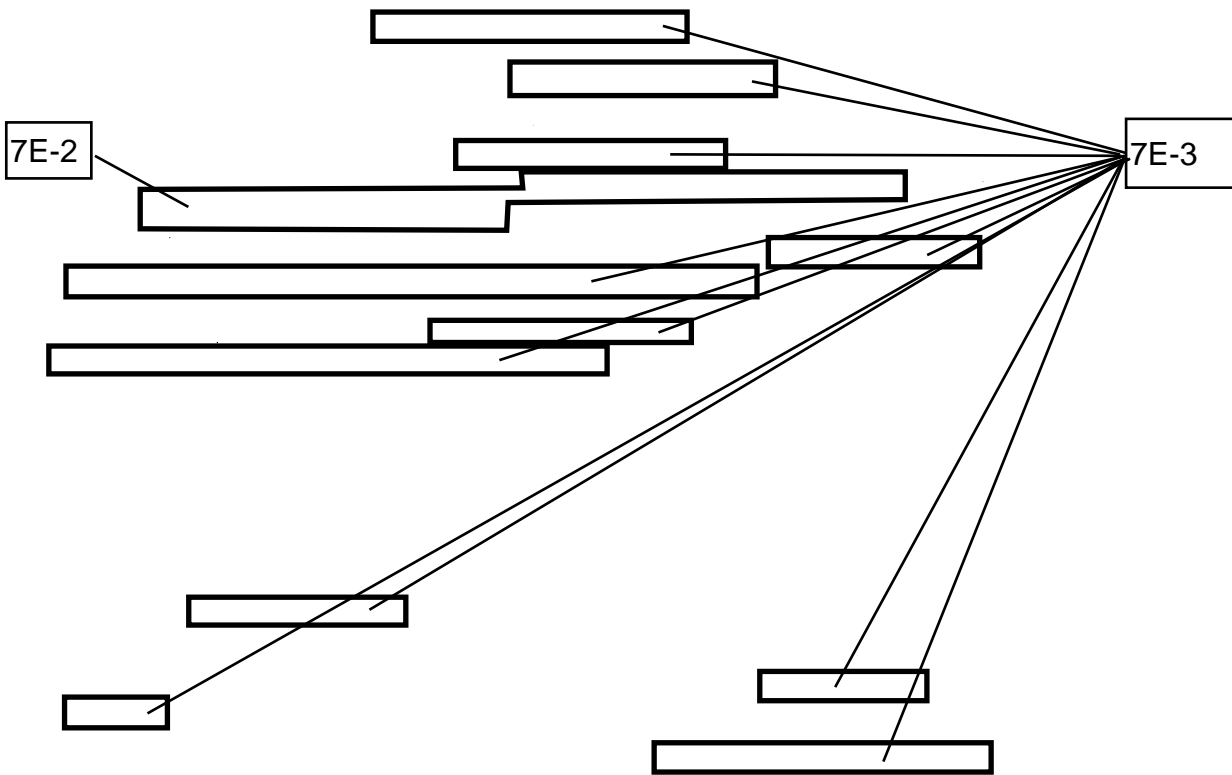

(b)(5),(b)(7)(A),(b)(7)(D),(b)(7)(E)

5-1

7E-3

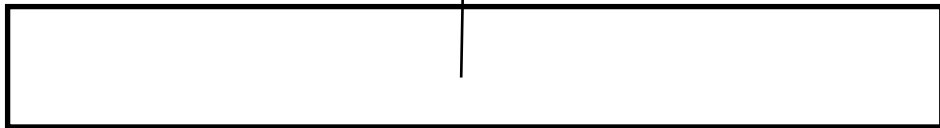

(b)(5), (b)(7)(A), (b)(7)(C), (b)(7)(D), (b)(7)(E), (b)(7)(F)

5-1

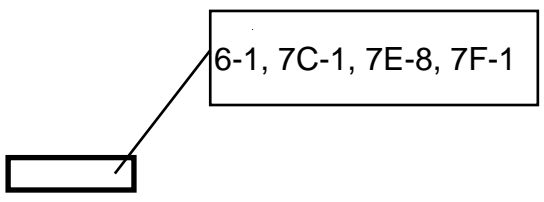
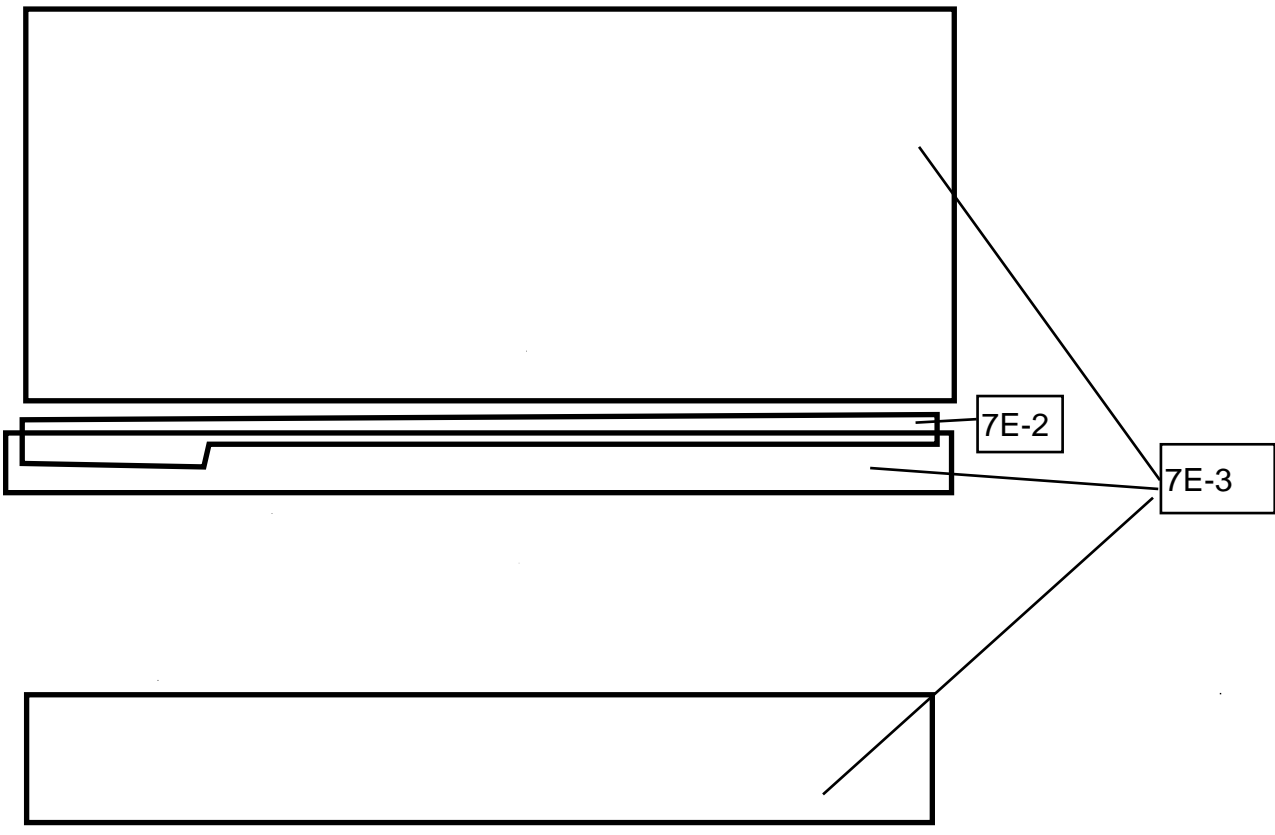

(b)(5),(b)(7)(A),(b)(7)(D),(b)(7)(E)

5-1

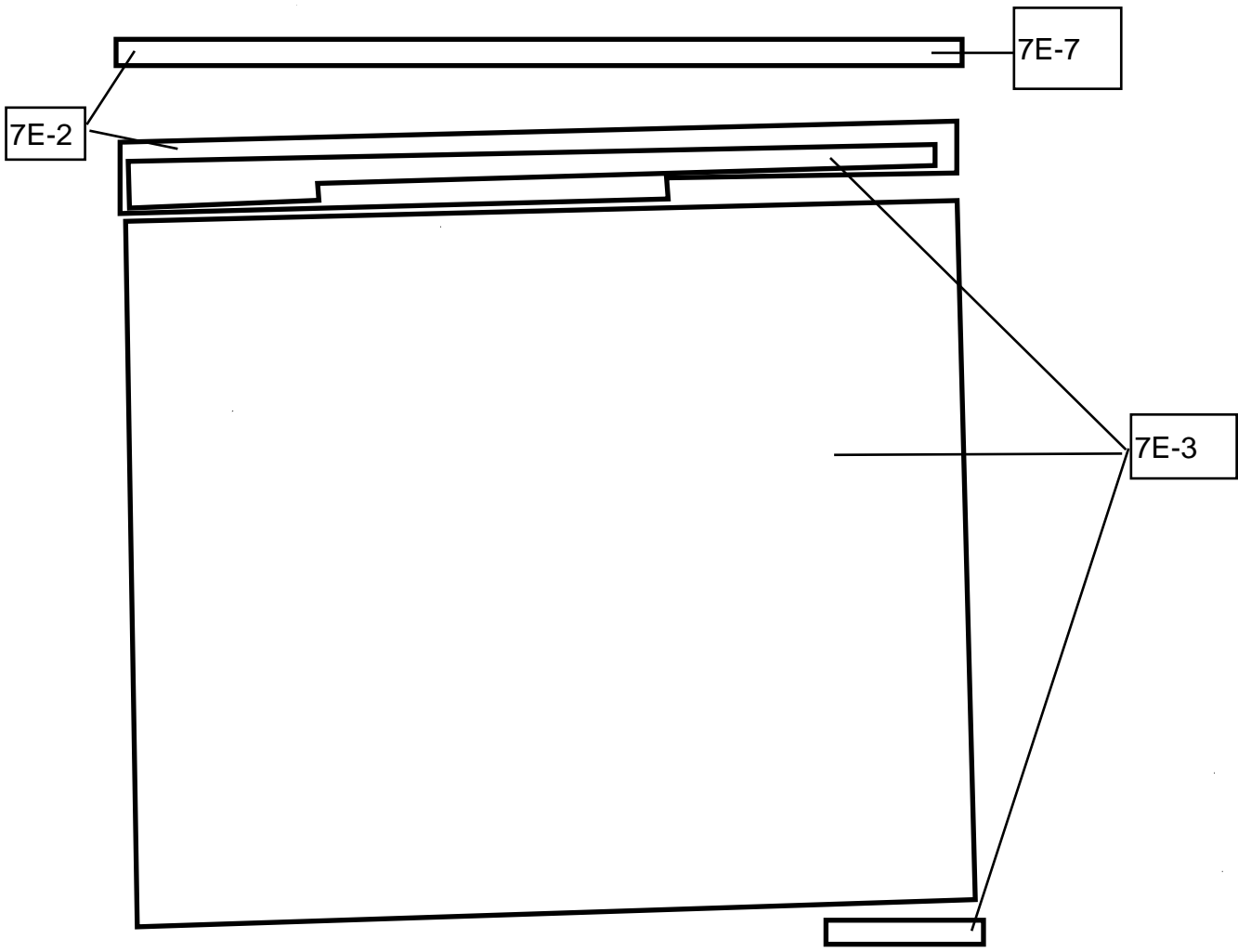

(b)(5),(b)(7)(A),(b)(7)(D),(b)(7)(E)

5-1

7E-2

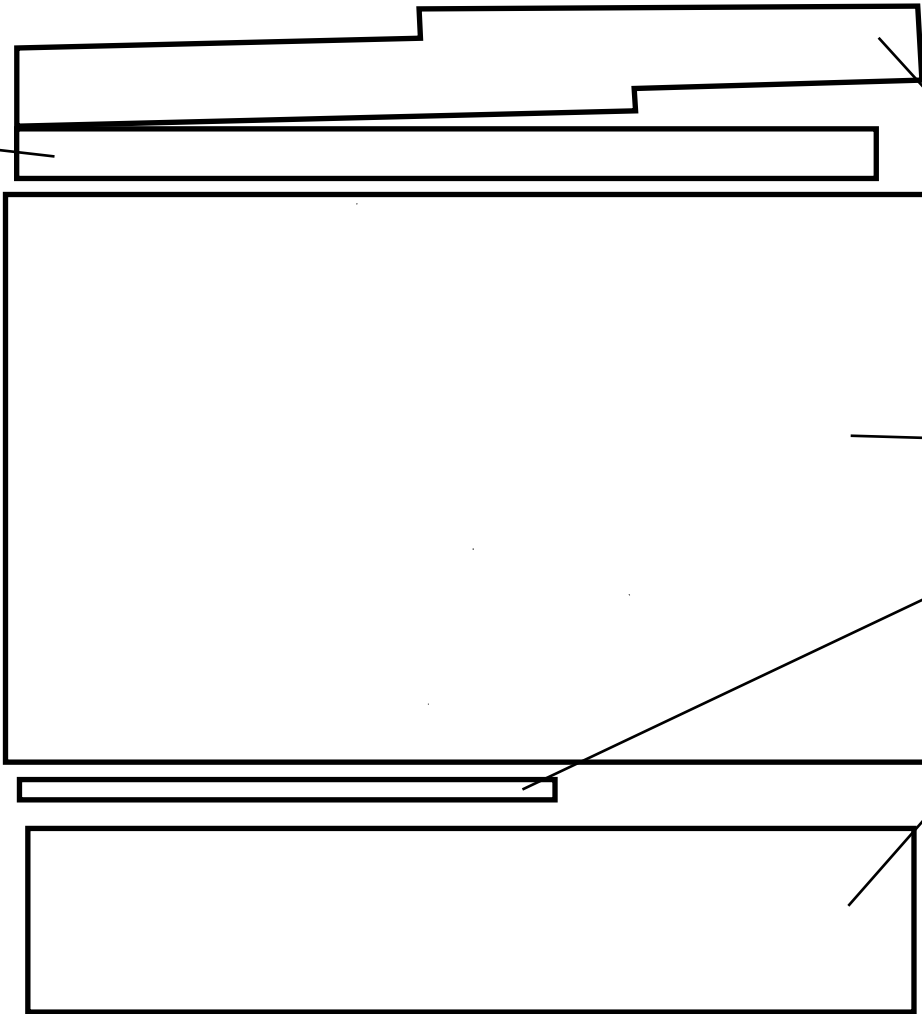

7E-3

(b)(5),(b)(7)(A),(b)(7)(D),(b)(7)(E)

5-1

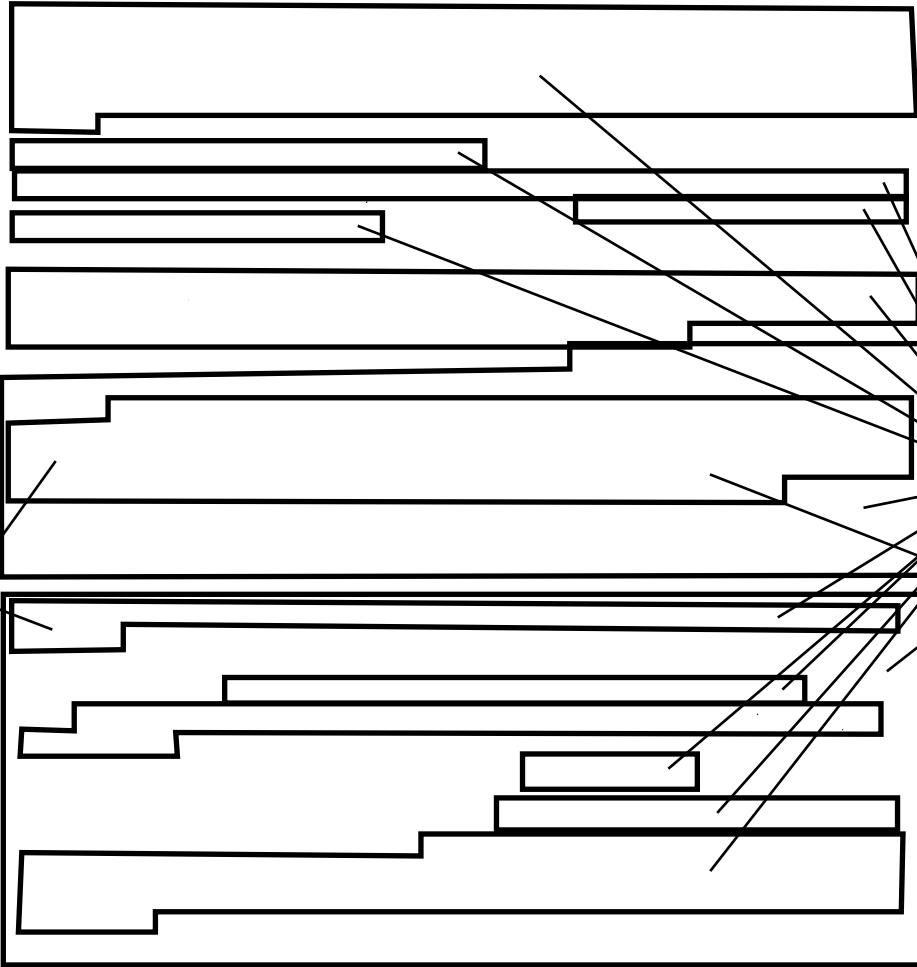

7E-7

7E-3

7E-2

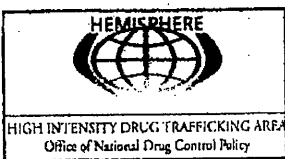

Hemisphere Project Request Form

7E-1

Please Fax When Complete

ISC Fax: (b)(7)(A), (b)(7)(E)

Master Case Number:	<input type="text"/>	Sub-Case Number:	<input type="text"/>	Date/Time:	<input type="text"/>
From:	<input type="text"/>	Email Results To:	<input type="text"/>	Priority:	<input type="text"/>
Secure Phone Number:	<input type="text"/>	Email Notification Of Completion To:	<input type="text"/>		
DTO Name (if applicable):		Case Name (if applicable):			
<input type="text"/>		<input type="text"/>			
HIDTA Initiative:	<input type="checkbox"/> Yes <input type="checkbox"/> No	HIDTA Initiative OR Law Enforcement Agency:	<input type="text"/>		
		Squad Name:	<input type="text"/>		
		Time Zone Results Requested In:	<input type="text"/>		

(b)(7)(A) (b)(7)(E)

7E-2



HIGH INTENSITY DRUG TRAFFICKING AREA
Office of National Drug Control Policy

Hemisphere Project Request Form

Please Fax When Complete

7E-1

LACLEAR Hemisphere Fax: (b)(7)(A), (b)(7)(C), (b)(7)(E)

Questions? Phone: (b)(7)(A), (b)(7)(C), (b)(7)(E)

Master Case Number:	<input type="text"/>	Sub- Case Number:	<input type="text"/>	Date:	<input type="text"/>
Drug Type Associated with Investigation:	Narcotic Related		Priority:	<input type="text"/>	
Submitting Agent/Analyst:	<input type="text"/>		Secure Phone Number:	<input type="text"/>	
Lead Case Agent if Different from Above:	<input type="text"/>				
Lead Case Agent Phone Number:	<input type="text"/>				
E-mail Results To:	<input type="text"/>		E-mail Notification of Completion To:	<input type="text"/>	
Drug Trafficking Organization/Name (if applicable):	<input type="text"/>				
Case Name (if applicable):	<input type="text"/>				
HIDTA Initiative: Yes <input type="checkbox"/> No <input type="checkbox"/>					
HIDTA Initiative OR Law Enforcement Agency:	<input type="text"/>				
Squad Name:	<input type="text"/>				
Time Zone Results Requested in:	<input type="text"/>				

(b)(7)(A) (b)(7)(E)

7E-2



HOUSTON HIDTA
HIGH INTENSITY DRUG TRAFFICKING AREA
Office of National Drug Control Policy

Hemisphere Project Request Form

Please Fax When Complete

7E-1

HISC Fax: (b)(7)(A),(b)(7)(E)

Master Case Number: Sub-Case Number: Date/Time:

DTO Name (if applicable): Case Name (if applicable):

HIDTA Initiative: Yes No HIDTA Initiative OR Law Enforcement Agency:
Squad Name:

From: Secure Phone Number: Priority:
To: Deliver Results To:

Email Address:

(b)(7)(A),(b)(7)(E)

7E-2

Phone Number	Previous Tasking Info	Priority	Date Range	
<input type="text"/>	<input type="checkbox"/> <input type="text"/>	<input type="text"/>	<input type="text"/>	<input type="text"/>
<input type="text"/>	<input type="checkbox"/> <input type="text"/>	<input type="text"/>	<input type="text"/>	<input type="text"/>
<input type="text"/>	<input type="checkbox"/> <input type="text"/>	<input type="text"/>	<input type="text"/>	<input type="text"/>
<input type="text"/>	<input type="checkbox"/> <input type="text"/>	<input type="text"/>	<input type="text"/>	<input type="text"/>
<input type="text"/>	<input type="checkbox"/> <input type="text"/>	<input type="text"/>	<input type="text"/>	<input type="text"/>
<input type="text"/>	<input type="checkbox"/> <input type="text"/>	<input type="text"/>	<input type="text"/>	<input type="text"/>
<input type="text"/>	<input type="checkbox"/> <input type="text"/>	<input type="text"/>	<input type="text"/>	<input type="text"/>
<input type="text"/>	<input type="checkbox"/> <input type="text"/>	<input type="text"/>	<input type="text"/>	<input type="text"/>
<input type="text"/>	<input type="checkbox"/> <input type="text"/>	<input type="text"/>	<input type="text"/>	<input type="text"/>
<input type="text"/>	<input type="checkbox"/> <input type="text"/>	<input type="text"/>	<input type="text"/>	<input type="text"/>
<input type="text"/>	<input type="checkbox"/> <input type="text"/>	<input type="text"/>	<input type="text"/>	<input type="text"/>
<input type="text"/>	<input type="checkbox"/> <input type="text"/>	<input type="text"/>	<input type="text"/>	<input type="text"/>
<input type="text"/>	<input type="checkbox"/> <input type="text"/>	<input type="text"/>	<input type="text"/>	<input type="text"/>
<input type="text"/>	<input type="checkbox"/> <input type="text"/>	<input type="text"/>	<input type="text"/>	<input type="text"/>
<input type="text"/>	<input type="checkbox"/> <input type="text"/>	<input type="text"/>	<input type="text"/>	<input type="text"/>
<input type="text"/>	<input type="checkbox"/> <input type="text"/>	<input type="text"/>	<input type="text"/>	<input type="text"/>
<input type="text"/>	<input type="checkbox"/> <input type="text"/>	<input type="text"/>	<input type="text"/>	<input type="text"/>
<input type="text"/>	<input type="checkbox"/> <input type="text"/>	<input type="text"/>	<input type="text"/>	<input type="text"/>
<input type="text"/>	<input type="checkbox"/> <input type="text"/>	<input type="text"/>	<input type="text"/>	<input type="text"/>
<input type="text"/>	<input type="checkbox"/> <input type="text"/>	<input type="text"/>	<input type="text"/>	<input type="text"/>



Introduction & Request Tutorial

HIGH INTENSITY DRUG TRAFFICKING AREA
Office of National Drug Control Policy



(b)(7)(A), (b)(7)(C), (b)(7)(D), (b)(7)(E), (b)(7)(F)

Hemisphere FAQ's



Submitting a Request:

<p>7E-2</p>	<p>7E-4</p> <p>7E-1</p>
-------------	-------------------------

b)(7)(A), (b)(7)(D), (b)(7)(E)

Hemisphere FAQ's



Preparing the Subpoena:

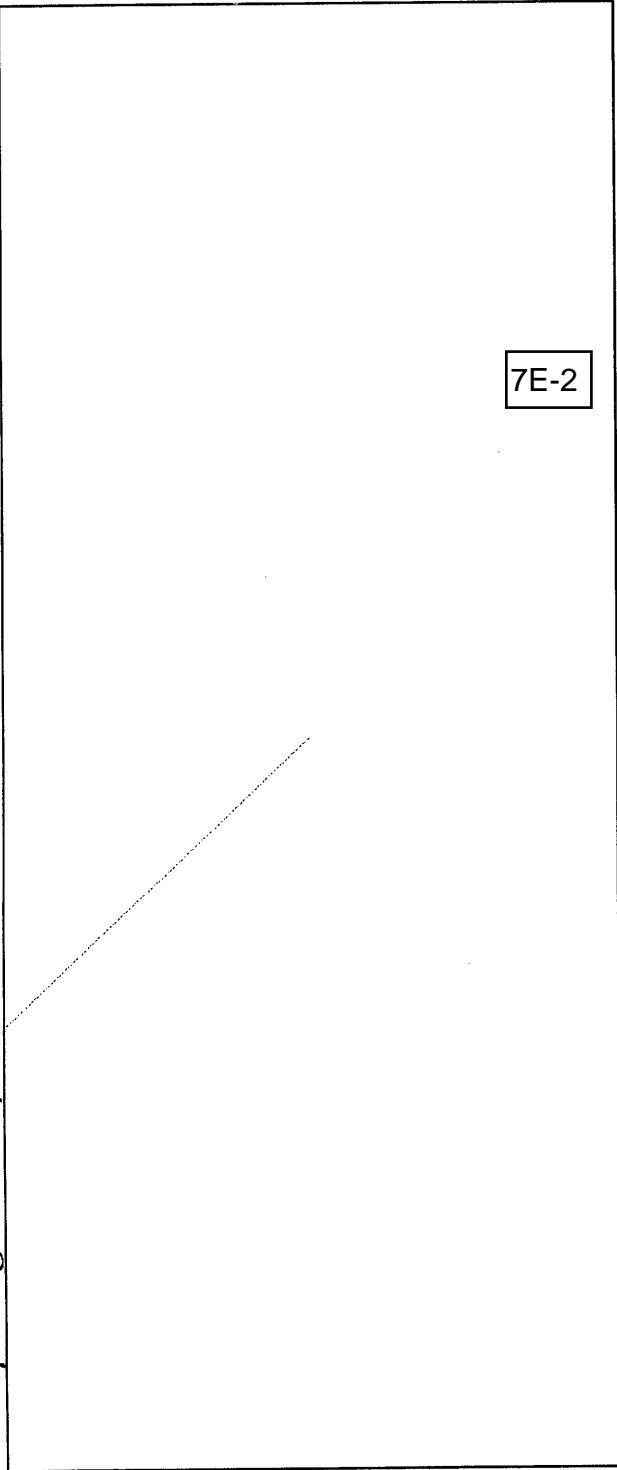

7E-2

(b)(7)(A), (b)(7)(D), (b)(7)(E)

Hemisphere FAQ's



Hemisphere Data Available to Requestors:

--	--	--	--

7E-3

7E-2

Hemisphere FAQ's



(7)(A), (b)(7)(D), (b)(7)(E)

Interpreting the Results:

7E-3

7E-7

(b)(7)(A), (b)(7)(D), (b)(7)(E)

Hemisphere FAQ's



Following Up on Requests:

7E-9

7E-4

7E-2

7E-3

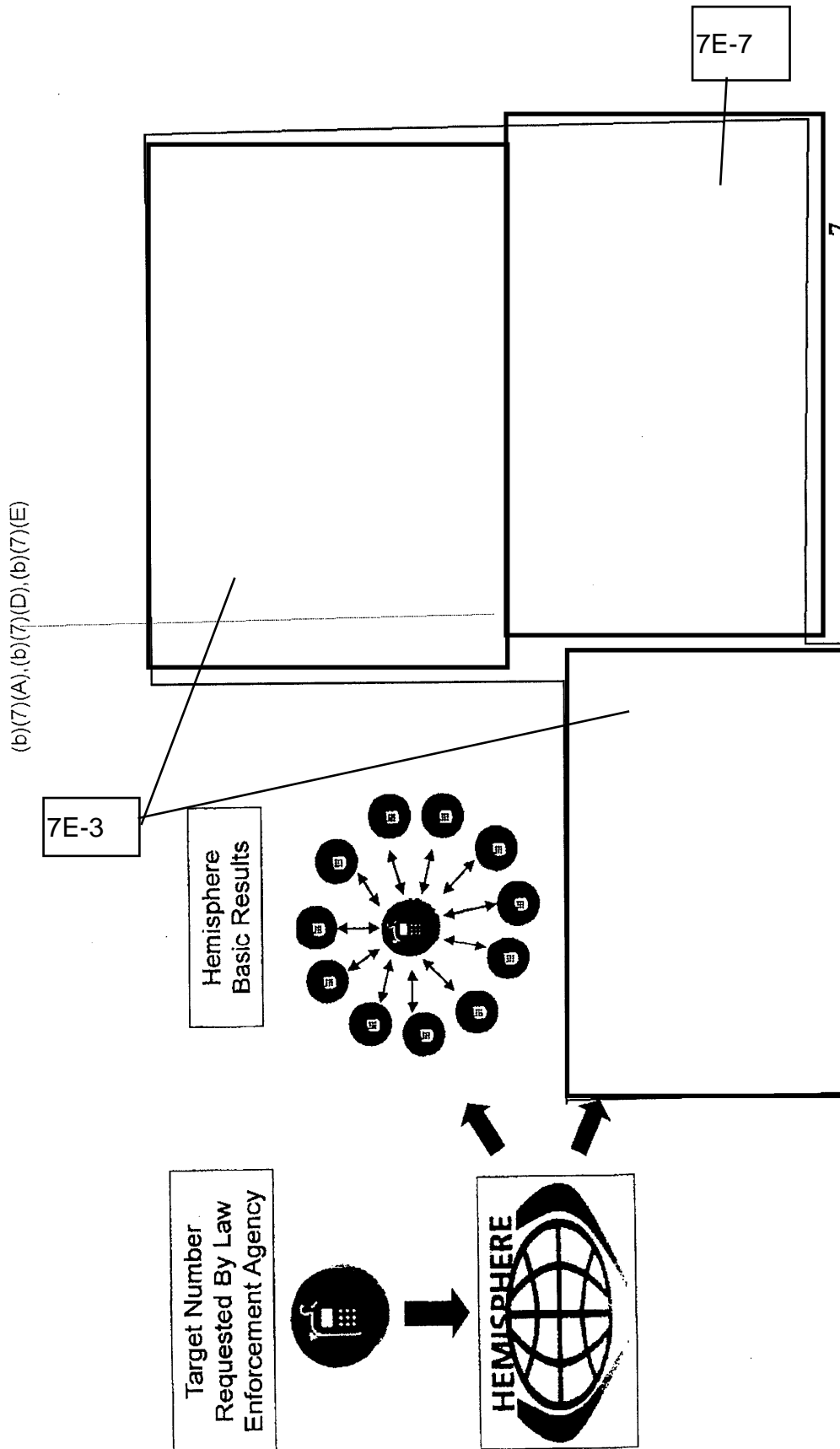

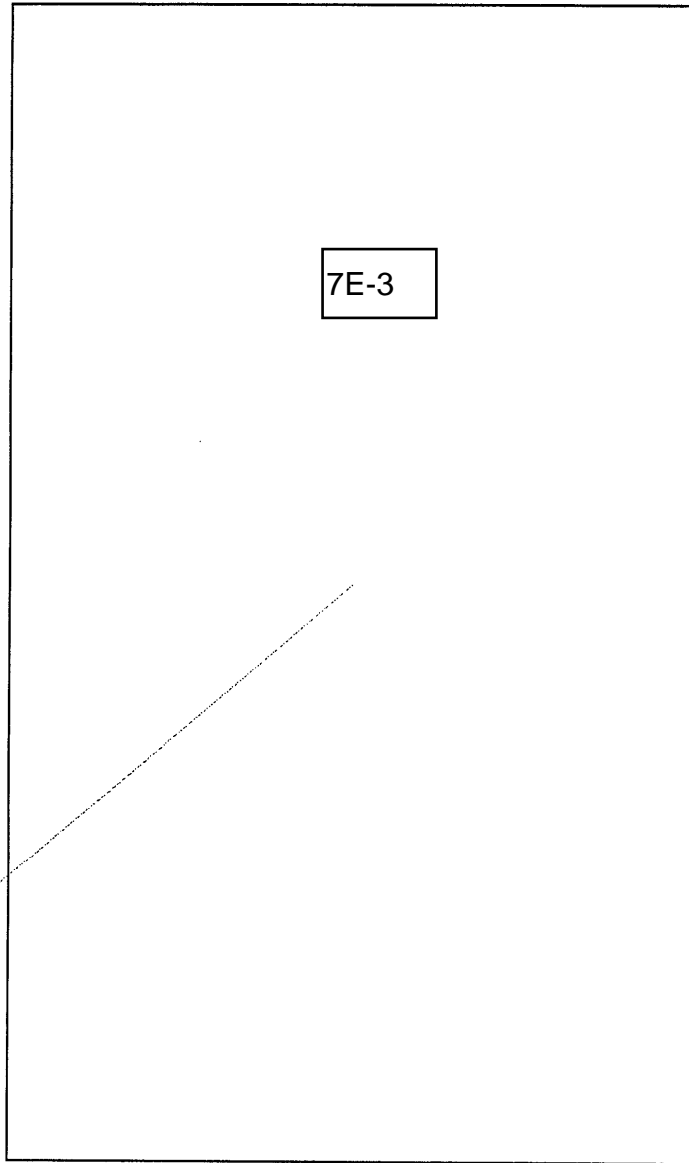

8

(b)(7)(A), (b)(7)(D), (b)(7)(E)

**Hemisphere
Basic Results**

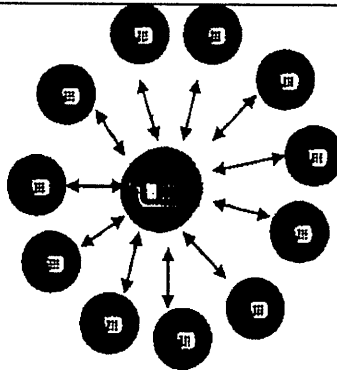

Submitting a Request

- Submitting a Request
- Hemisphere Request Process
- Hemisphere Subpoena- Official Language
- Hemisphere Subpoena- Date Ranges
- Subpoena Examples
- Court Order Example (for Los Angeles Hemisphere only)
- Hemisphere Subpoena- 7E-2
- Examples

(b)(7)(A), (b)(7)(D), (b)(7)(E)

(b)(7)(A), (b)(7)(E), (b)(7)(F)

Hemisphere Request Process



Law
Enforcement
Agencies

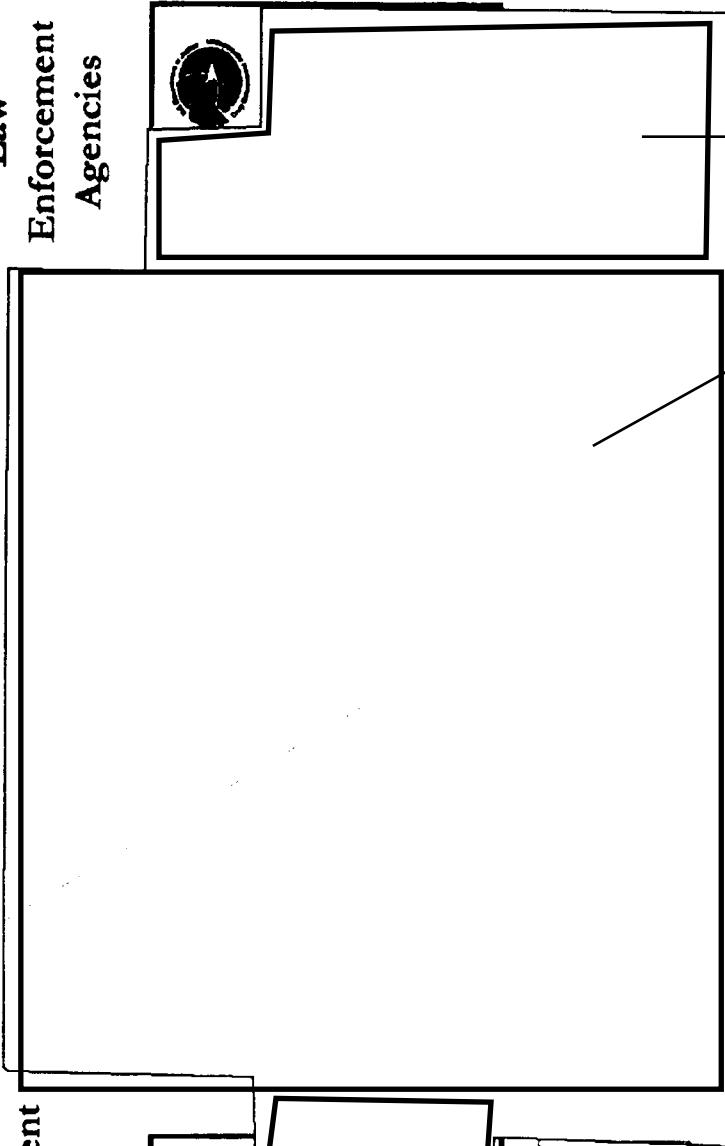

7E-5

7E-4

Law Enforcement
Agencies

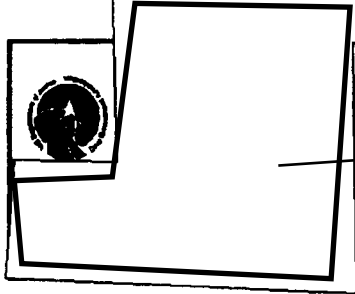

Agencies
generate
request forms
and subpoenas

7E-5

(b)(7)(A), (b)(7)(D), (b)(7)(E)



HEMISPHERE SUBPOENA- Official Language

7E-2

7E-3

b)(7)(A), (b)(7)(E)

HEMISPHERE SUBPOENA-
Official Language



**The below wording must appear on all Hemisphere
subpoenas:**

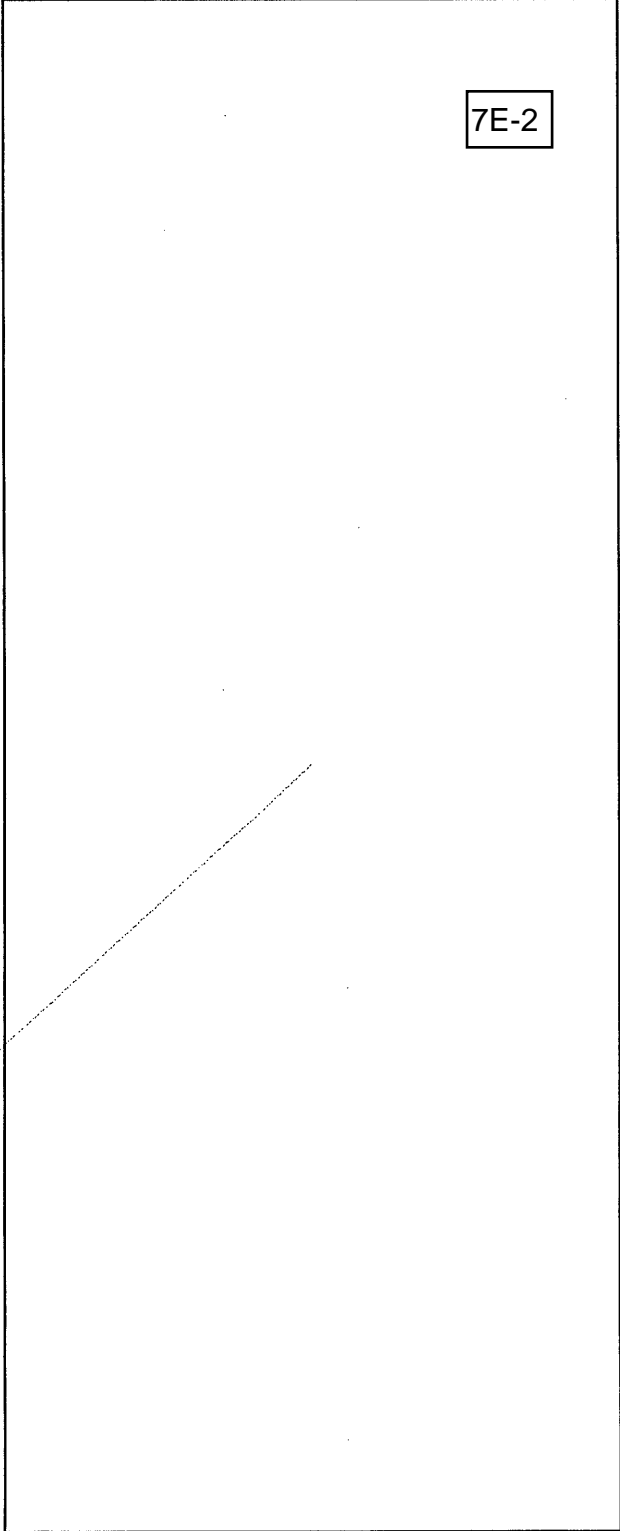

(b)(7)(A), (b)(7)(E)



HEMISPHERE SUBPOENA-

Date Ranges

7E-2

(b)(7)(A), (b)(7)(D), (b)(7)(E)

HEMISPHERE SUBPOENA-

Date Ranges



7E-2

7E-3

(b)(7)(A), (b)(7)(D), (b)(7)(E), (b)(7)(F)



HEMISPHERE SUBPOENA-

Date Ranges

7E-2

7E-5

7D-1, 7E-6

(b)(6), (b)(7)(A), (b)(7)(C), (b)(7)(D), (b)(7)(E), (b)(7)(F)

U.S. DEPARTMENT OF JUSTICE / DRUG ENFORCEMENT ADMINISTRATION

SUBPOENA

In the matter of the investigation of

[Redacted]



7E-2

7D-1, 7E-6

7E-5

6-1, 7C-1, 7E-8, 7F-1

7E-2

7D-1, 7E-6

7E-5

6), (b)(7)(A), (b)(7)(C), (b)(7)(D), (b)(7)(E), (b)(7)(F)

7E-5

7D-1, 7E-6

7E-2

7E-5

6-1, 7C-1, 7E-8, 7F-1

[Redacted]

[Redacted]

[Redacted]

[Redacted]

(b) (7)(A), (b) (7)(C), (b) (7)(D), (b) (7)(E), (b) (7)(F)

7E-2

7E-5

7E-5

7D-1, 7E-6

6-1, 7C-1, 7E-8, 7F-1

(6), (b) (7)(A), (b) (7)(C), (b) (7)(D), (b) (7)(E), (b) (7)(F)

7E-2

7E-5

7E-5

7D-1, 7E-6

(b)(7)(A), (b)(7)(C), (b)(7)(D), (b)(7)(E), (b)(7)(F)

(b)(7)(A), (b)(7)(E)

COURT ORDERS FOR CALIFORNIA SUBMISSIONS ONLY!



1
2
3
4
5
6

IN THE SUPERIOR COURT OF THE STATE OF CALIFORNIA

IN AND FOR THE COUNTY OF (insert County)

IN THE MATTER OF THE APPLICATION)
OF INVESTIGATOR (insert Name))
FOR AN ORDER AUTHORIZING)
THE RELEASE OF PHONE RECORDS)

COURT ORDER

UNDER SEAL

[Large empty rectangular box for court order content]

7E-2

(b)(7)(A), (b)(7)(D), (b)(7)(E)

COURT ORDERS FOR CALIFORNIA SUBMISSIONS ONLY!

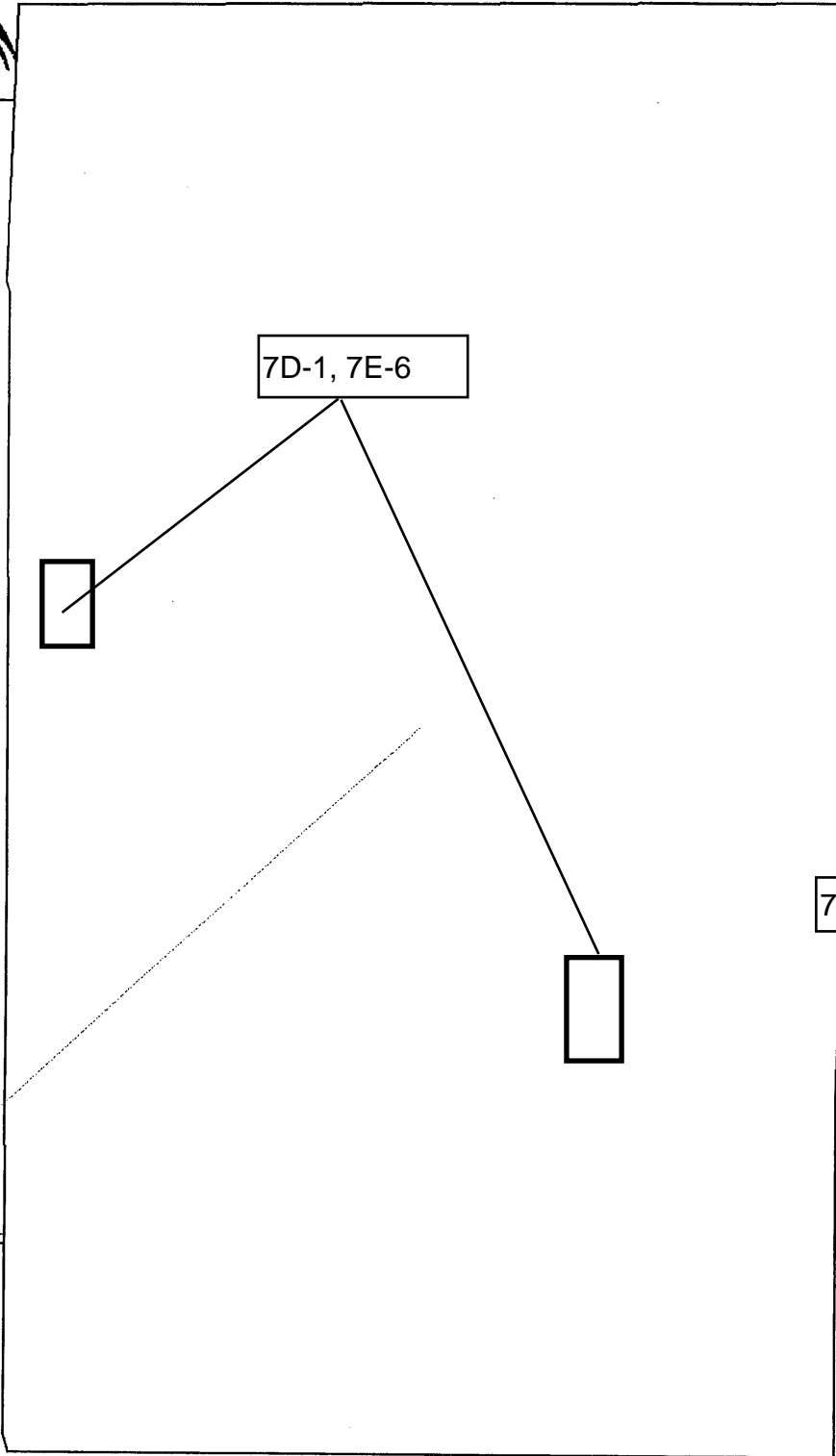

(b)(7)(A), (b)(7)(D), (b)(7)(E)

**COURT ORDERS FOR CALIFORNIA
SUBMISSIONS ONLY!**



7D-1, 7E-6

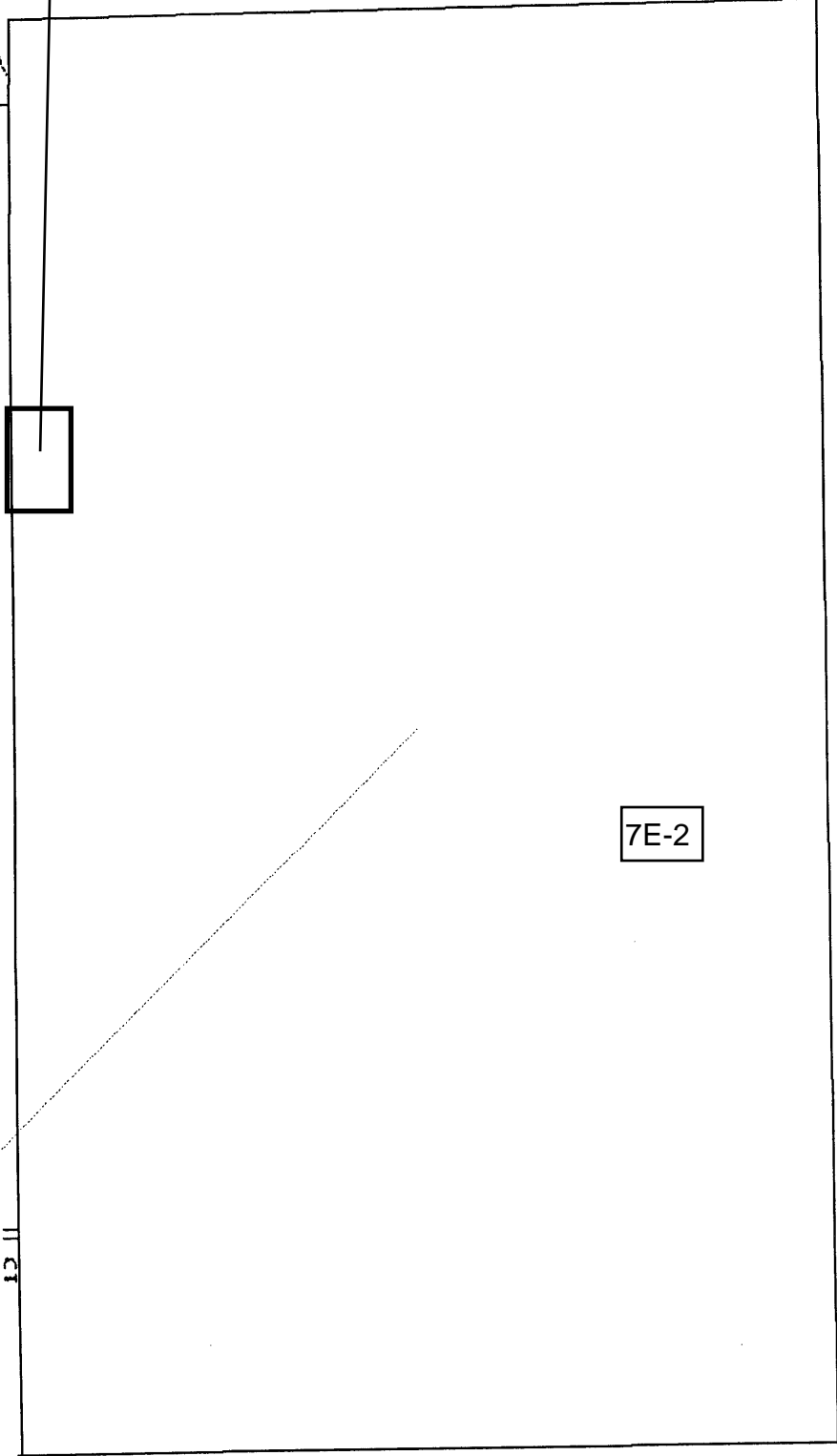

7E-2

(b)(7)(A), (b)(7)(D), (b)(7)(E)

**COURT ORDERS FOR CALIFORNIA
SUBMISSIONS ONLY!**

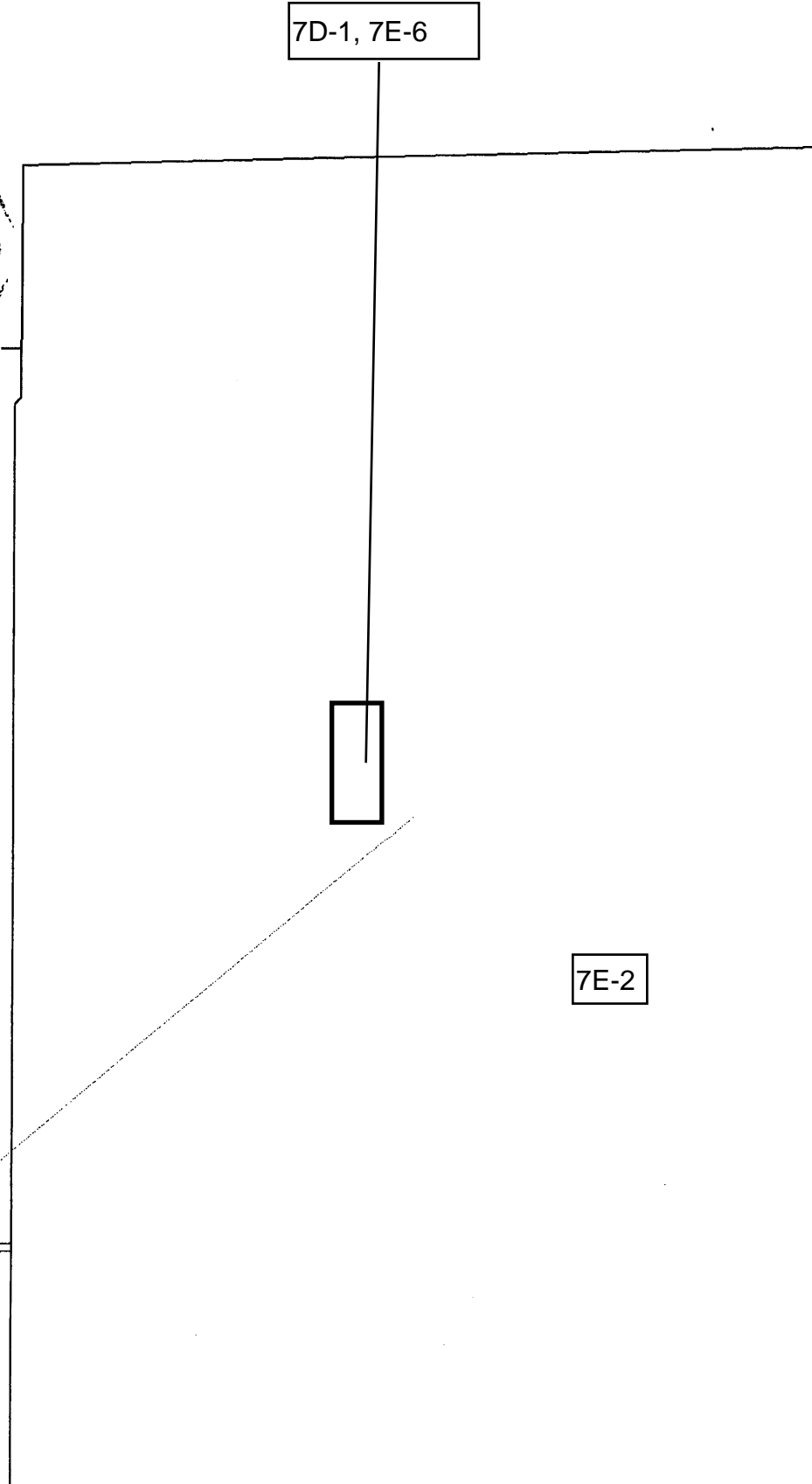

Practical Exercises



■ § 1.0 CREATING SUBPOENAS

(b)(7)(A), (b)(7)(D), (b)(7)(E)

HEMISPHERE SUBPOENA-



7E-2

7E-3

7E-4

7E-2

(7)(A), (b)(7)(E)

7E-2

(b)(7)(A), (b)(7)(E)

7E-2

) (7)(A), (b) (7)(E)

7E-2

o)(7)(A),(b)(7)(E)

7E-2

(7)(A), (b)(7)(E)

(b)(7)(A),(b)(7)(D),(b)(7)(E)

7E-2

7E-2

(7)(A), (b)(7)(D), (b)(7)(E)

(b)(7)(A), (b)(7)(D), (b)(7)(E)



HEMISPHERE REQUEST FORM-

General Instructions

- Valid email and telephone numbers are critical for the successful delivery of your request
- **Point of Contact section(s):** Must be completed on ALL requests
 - The Point of Contact must always be recognized as belonging to a HIDTA Intelligence Support Center
- **Requestor section(s):** Will be populated if the request is for an untrained user who is submitting through a P.O.C.

7E-2

(b)(7)(A), (b)(7)(D), (b)(7)(E)



HEMISPHERE REQUEST FORM

General Instructions

- **Priority section:** This section determines the urgency level of the request

7E-3

7E-2

7E-9

(b)(7)(A), (b)(7)(D), (b)(7)(E)



HEMISPHERE REQUEST FORM - General Instructions

- **Priority section:** This section determines the urgency level of the request

7E-2
7E-9

s)(7)(A), (b)(7)(D), (b)(7)(E)



HEMISPHERE REQUEST FORM-

General Instructions

- **Priority section:** This section determines the urgency level of the request

7E-2

7E-9

(b)(7)(A), (b)(7)(D), (b)(7)(E)



HEMISPHERE REQUEST FORM-

Basic Requests

7E-2		7E-7	7E-3
------	--	------	------

(b)(7)(A), (b)(7)(D), (b)(7)(E)



HEMISPHERE REQUEST FORM

[Redacted content]

7E-2

7E-3



HOUSTON HIDTA
HIGH INTENSITY DRUG TRAFFICKING AREA
Office of National Drug Control Policy

Hemisphere Project Request Form

HOUSTON HIDTA

Printed Name

Please Fax When Complete

HISC Fax: (b)(7)(A), (b)(7)(E)

7E-1

Master Case Number: []

Priority: []

HIDTA Point of Contact Name: []

POC Phone Number: []

Email Notification Of Completion: []

All request forms must contain information for a HIDTA Intelligence Support Center Hemisphere Point of Contact

Requestor Name: []

Requestor Phone Number: []

Email Notification: []

"Requestor Name" and Information will only be populated if the request is for an untrained user who is submitting through a POC

DTO Name (if applicable): []

HIDTA Initiative: []

HIDTA Initiative OR Law Enforcement Agency: []

Yes No

All Hemisphere Requests must go through a HIDTA ISC POC



Please Fax When Complete

HISC Fax: (b)(7)(A), (b)(7)(E)

7E-1

Hemisphere Project Request Form

HOUSTON HIDTA



HOUSTON HIDTA
HIGH INTENSITY DRUG TRAFFICKING AREA
Office of National Drug Control Policy

Master Case Number:	Priority:	Current Date:	2008-07-23 07:38:34
HIDTA Point of Contact Name:	Email Results To:	Email Notification Of Completion To:	
POC Phone Number:	Email Results To:	Email Notification Of Completion To:	
Requestor Name:	Case Name (if applicable):		
Requestor Phone Number:	HIDTA		
DTO Name (if applicable):	Yes		

Field(s) most important to ensuring that your results are returned in a timely fashion



Hemisphere Project Request Form HOUSTON HIDTA

HOUSTON HIDTA
HIGH INTENSITY DRUG TRAFFICKING AREA
Office of National Drug Control Policy

Printed Form

Please Fax When Complete

HISC Fax: (b)(7)(A), (b)(7)(E)

7E-1

Master Case Number:	Priority:	Current Date:	2008-07-23 07:38:34
HIDTA Point of Contact Name:	Email:	This field aids Hemisphere in assigning your request the appropriate level of action	
POC Phone Number:	Email Notification:		
Requestor Name:	Email Results To:		
Requestor Phone Number:	Email Notification Of Completion To:		
DTO Name (if applicable):	Case Name (if applicable):		
HIDTA Initiative:	HIDTA Initiative OR Law Enforcement Agency:		
Yes <input type="checkbox"/> No <input type="checkbox"/>	Squad Name:		
	Time Zone Results Requested In:		



HOUSTON HIDTA
HIGH INTENSITY DRUG TRAFFICKING AREA
Office of National Drug Control Policy

Hemisphere Project Request Form HOUSTON HIDTA

CONFIDENTIAL

Please Fax When Complete

HISC Fax: (b)(7)(A), (b)(7)(E)

7E-1

Master Case Number: [Redacted] **Priority:** [Redacted] **Current Date:** 2008-07-23 07:38:34

HIDTA Point of Contact Name: [Redacted] **Email Results To:** [Redacted]

POC Phone Number: [Redacted] **Email Notification Of Completion To:** [Redacted]

Requestor Name: [Redacted] **Email:** [Redacted]

Requestor Phone Number: [Redacted]

DTO Name (if applicable): [Redacted]

HIDTA Initiative: Yes No **HIDTA Initiative OR Law Enforcement Agency:** [Redacted]

Squad Name: [Redacted] **Time Zone Results:** [Redacted]

HIDTA: [Redacted] **NON HIDTA:** (b)(7)(C)

Indicate HIDTA/non HIDTA and what agency the request should be credited to

7E-5



HOUSTON HIDTA
HIGH INTENSITY DRUG TRAFFICKING AREA
Office of National Drug Control Policy

Hemisphère Project Request Form HOUSTON HIDTA

Please Fax When Complete

HISCFax: (b)(7)(A), (b)(7)(E)

HISMISDHFIRE



Master Case Number: Priority: Current Date: 2008-07-23 07:38:34

HIDTA Point of Contact Name: Email Results To:

POC Phone Number: Email Notification of Completion To:

Requestor Name: Email Results To:

Requestor Phone Number: Email Notification Of:

DTO Name (if applicable):

HIDTA Initiative: HIDTA Initiative OR Law Enforcement Agency:

Yes No Squad Name:

Time Zone Results Requested In:

Background / Justification / Excerpts on

Indicate what squad within your agency the request should be credited to

- HIDTA - HISC IRT
- HIDTA - HISC IS
- HIDTA - HISC IRT
- NON HIDTA - (b)(7)(A), (b)(7)(E)
- NON HIDTA - (b)(7)(E)
- NON HIDTA -
- NON HIDTA -

7E-5

7E-2

7E-3

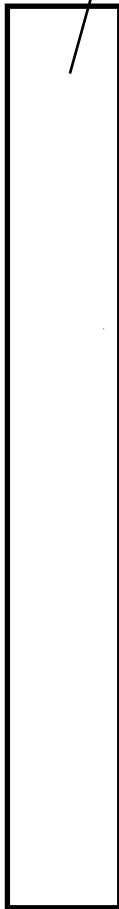

7E-5

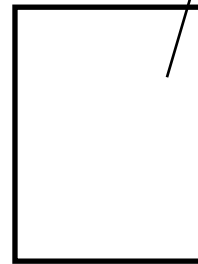

(7)(A), (b)(7)(D), (b)(7)(E)

Phone Number	Priority	Date Range	Date Range
(b)(7)(C) 7E-5		June 23, 2008	July 1, 2008
		March 6, 2008	July 1, 2008
		March 6, 2008	July 1, 2008

Multiple date ranges can be requested; however this will result in requests being split

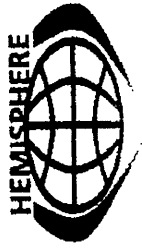

Practical Exercises

- § 2.0 COMPLETING THE REQUEST FORM

(b)(7)(A), (b)(7)(C), (b)(7)(E), (b)(7)(F)



The Next Step

7E-1

7E-2

7E-4

7E-7

This block contains a large rectangular area with a black border. Inside, there are several smaller rectangular boxes and lines. A box labeled "7E-1" has two lines pointing to a vertical rectangle. A box labeled "7E-2" is positioned above a box labeled "7E-4". A box labeled "7E-7" has a line pointing to the top edge of the main rectangle.



Review- Submitting a Request

7E-2

7E-4

(b)(7)(A), (b)(7)(D), (b)(7)(E)

(b)(7)(A), (b)(7)(D), (b)(7)(E)

Hemisphere Products:

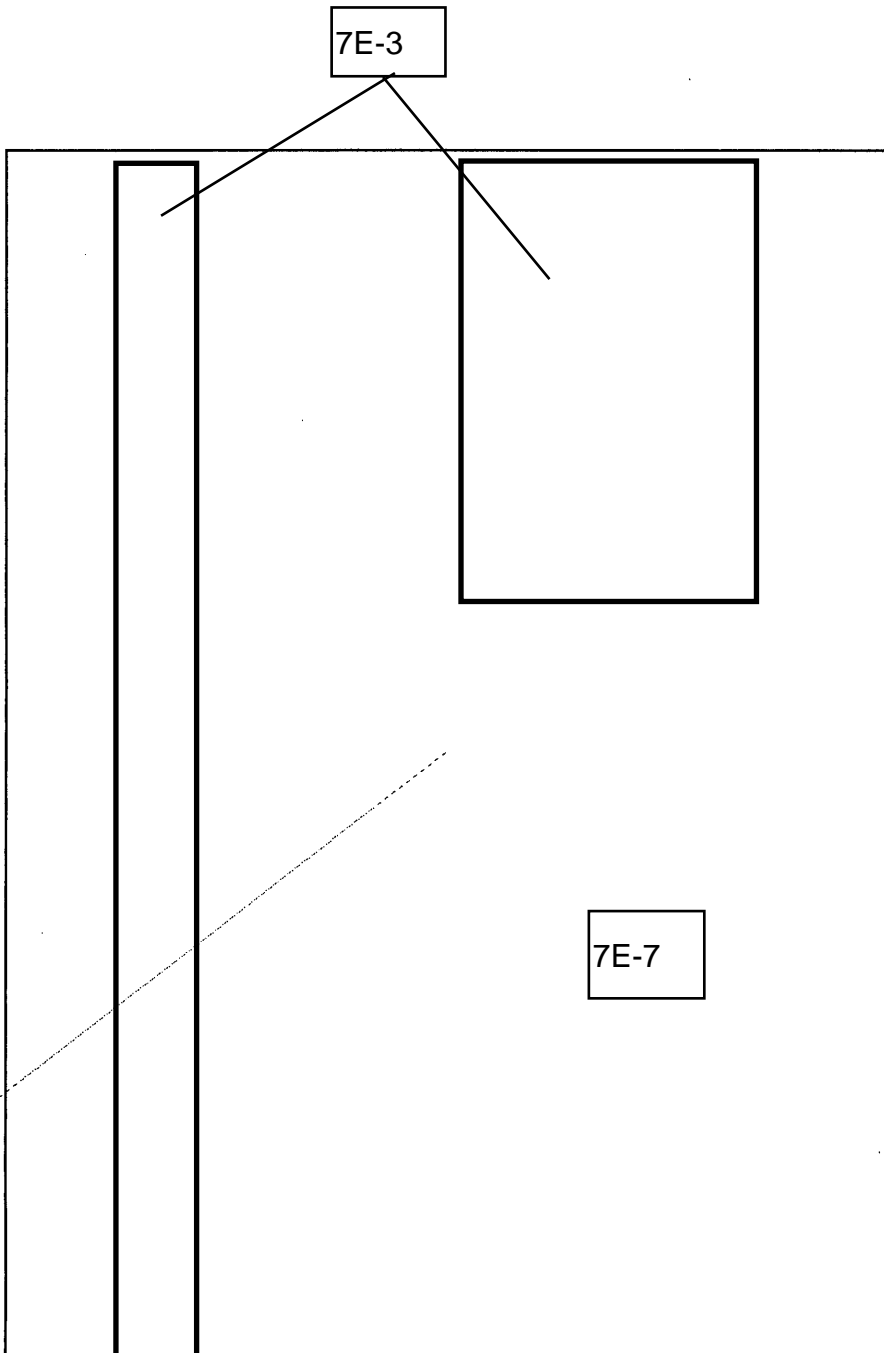



7E-3

(b)(7)(A), (b)(7)(D), (b)(7)(E)



7E-3

(b)(7)(A), (b)(7)(D), (b)(7)(E)



7E-3

(b)(7)(A), (b)(7)(D), (b)(7)(E)



7E-7

7E-2

7E-3

(b)(7)(A), (b)(7)(D), (b)(7)(E)

(b)(7)(E)

The Evolution of Hemisphere Results

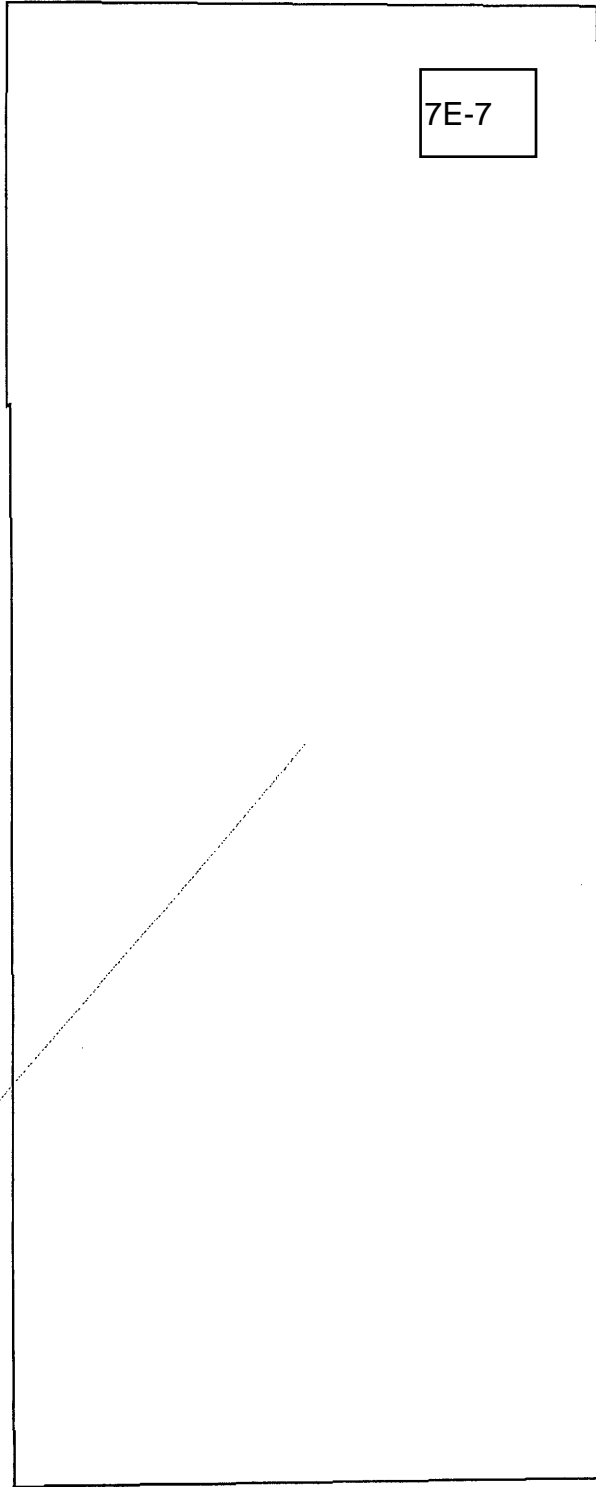

7E-7

Practical Exercises



- § 3.1 Contents of Results Email
-

(b)(7)(A);(b)(7)(E)



Understanding the

7E-7

7E-7

6-1, 7C-1, 7E-8, 7F-1



b)(6), (b)(7)(A), (b)(7)(C), (b)(7)(D), (b)(7)(E), (b)(7)(F)

7E-7

7E-3



(b)(7)(A), (b)(7)(C), (b)(7)(D), (b)(7)(E), (b)(7)(F)



Practical Exercises

- § 3.2
(b)(7)(A), (b)(7)(E)
7E-7



7E-3

7E-7

7D-1, 7E-6

Overview

(b)(7)(A), (b)(7)(D), (b)(7)(E)

7E-7

b)(7)(A), (b)(7)(C), (b)(7)(D), (b)(7)(E)



7E-3

7E-7

(b)(7)(A), (b)(7)(D), (b)(7)(E)

7E-7

b)(7)(A), (b)(7)(C), (b)(7)(D), (b)(7)(E)



7E-7

7E-3

(b)(7)(A), (b)(7)(D), (b)(7)(E)



Practical Exercises

[Redacted]

■ § 3.3

(b)(7)(E)

7E-7

7(A), (b)(7)(C), (b)(7)(D), (b)(7)(E)

7E-7

(b)(7)(A), (b)(7)(C), (b)(7)(D), (b)(7)(E)



Practical Exercises

[Redacted]

7E-7

(b)(7)(A), (b)(7)(D), (b)(7)(E) ■ § 3.4



7E-3

7E-7

(b)(7)(A), (b)(7)(D), (b)(7)(E)

7E-7

7E-3

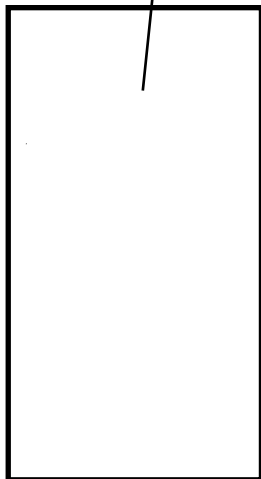
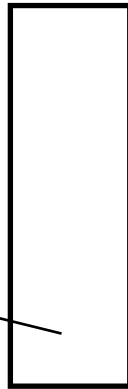

(7)(A), (b)(7)(C), (b)(7)(D), (b)(7)(E)



Practical Exercises

[Redacted]

(b)(7)(A), (b)(7)(D), (b)(7)(E) ■ § 3.5

7E-7



7E-7

(b)(7)(A), (b)(7)(D), (b)(7)(E)

7E-7

b)(7)(A), (b)(7)(C), (b)(7)(D), (b)(7)(E)



7E-7

(b)(7)(A), (b)(7)(D), (b)(7)(E)

7E-7

b)(7)(A), (b)(7)(C), (b)(7)(D), (b)(7)(E)

Practical Exercises



[Redacted]

§ 3.6

(b)(7)(A), (b)(7)(D), (b)(7)(E)

7E-7



7E-7

(b)(7)(A), (b)(7)(D), (b)(7)(E)



7E-3

7E-7

(b)(7)(A), (b)(7)(D), (b)(7)(E)

7E-7

b)(7)(A), (b)(7)(C), (b)(7)(D), (b)(7)(E)



Practical Exercises

[Redacted]

7E-3

7E-7

(b)(7)(A), (b)(7)(D), (b)(7)(E) ■ § 3.7



7E-7

7E-3

7E-2

(b)(7)(A), (b)(7)(D), (b)(7)(E)

7E-7

7E-3

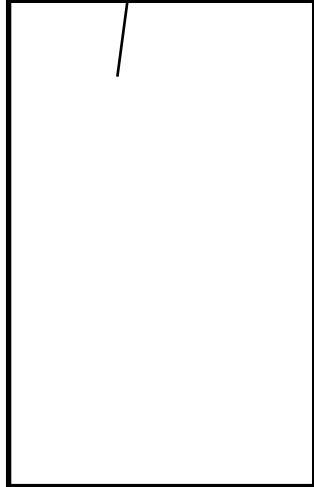

(7)(A), (b)(7)(C), (b)(7)(D), (b)(7)(E)

7E-7

(b)(7)(A), (b)(7)(C), (b)(7)(D), (b)(7)(E)



7E-3

7E-7

(b)(7)(A), (b)(7)(D), (b)(7)(E)

7E-7

7E-3

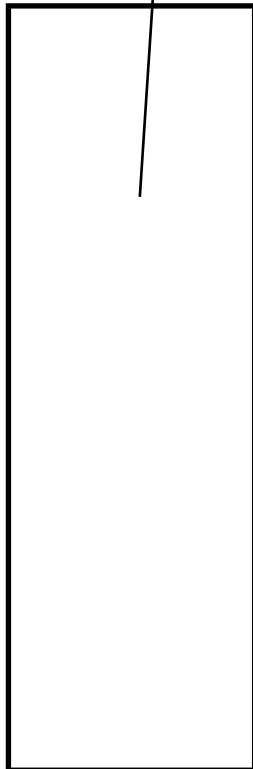

b)(7)(A), (b)(7)(C), (b)(7)(D), (b)(7)(E)



Practical Exercises

(b)(7)(A), (b)(7)(D), (b)(7)(E) ■ § 3.8

7E-3

7E-7



7E-3

7E-7

(b)(7)(A), (b)(7)(D), (b)(7)(E)

7E-7

7E-3

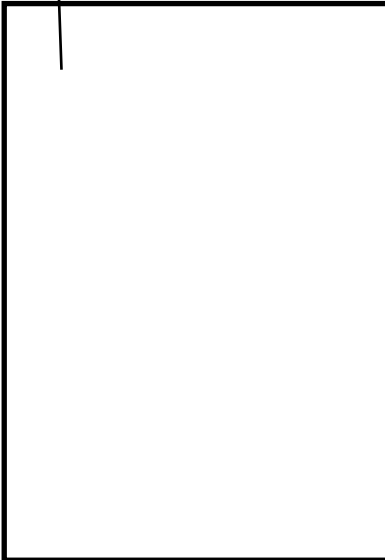
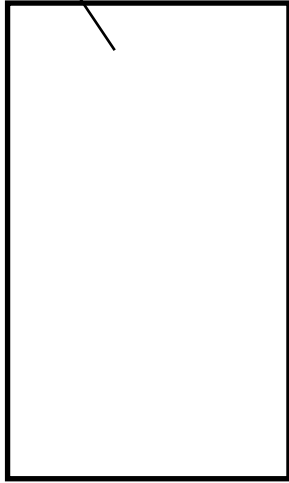
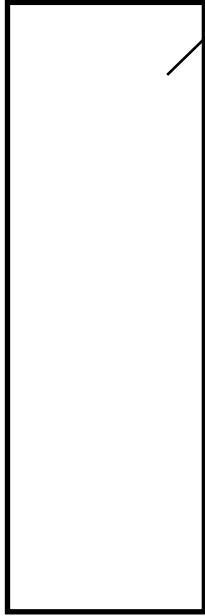

(b)(7)(A), (b)(7)(C), (b)(7)(D), (b)(7)(E)



7E-3

7E-7

(b)(7)(A), (b)(7)(D), (b)(7)(E)

7E-7

7E-3

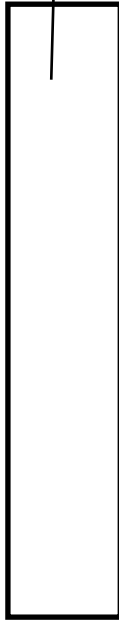

(7)(A),(b)(7)(C),(b)(7)(D),(b)(7)(E)



Practical Exercises

(b)(7)(A), (b)(7)(D), (b)(7)(E) ■ § 3.9

[Redacted]

7E-3

7E-7



7E-7

7E-3

(b)(7)(A), (b)(7)(D), (b)(7)(E)

7E-7

b)(7)(A), (b)(7)(C), (b)(7)(D), (b)(7)(E)

7E-7

(b)(7)(A), (b)(7)(C), (b)(7)(D), (b)(7)(E)



Practical Exercises

7E-3
7E-7

[Redacted]

§ 3.10

(b)(7)(A), (b)(7)(D), (b)(7)(E)



7E-3

7E-7

(b)(7)(A), (b)(7)(D), (b)(7)(E)

7E-7

7E-3

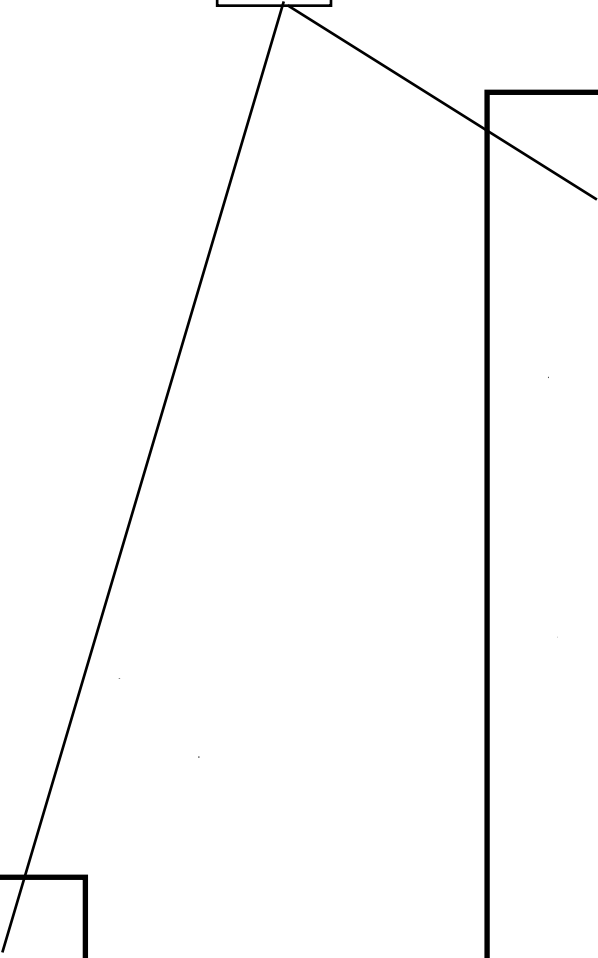
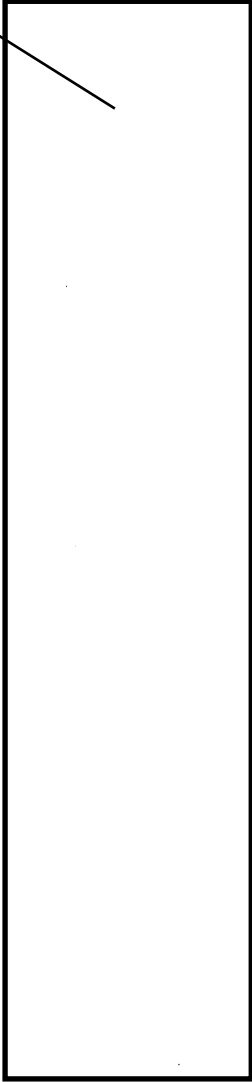
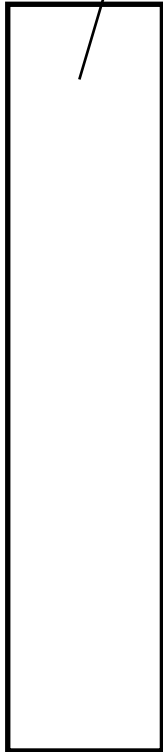

b)(7)(A), (b)(7)(C), (b)(7)(D), (b)(7)(E)



Practical Exercises

[Redacted]

b)(7)(A), (b)(7)(D), (b)(7)(E) ■ § 4.0

7E-3

7E-7



7E-7

(b)(7)(A), (b)(7)(D), (b)(7)(E)

7E-7

(b)(7)(A), (b)(7)(C), (b)(7)(D), (b)(7)(E)



7E-7

(b) (7)(A), (b) (7)(D), (b) (7)(E)

7E-7

(7)(A), (b)(7)(C), (b)(7)(D), (b)(7)(E)

Practical Exercises



(b)(7)(A),(b)(7)(E) ■ § 5.0

[Redacted]

7E-7

(b)(7)(A), (b)(7)(D), (b)(7)(E)

Review- Hemisphere Products:



7E-7

7E-3

(b)(7)(A), (b)(7)(D), (b)(7)(E)

Hemisphere Products:

- Understanding the Results Email

7E-3

7E-7

(b)(7)(A), (b)(7)(D), (b)(7)(E)



Understanding the Results Email

7E-3

7E-7

7E-7

7E-3

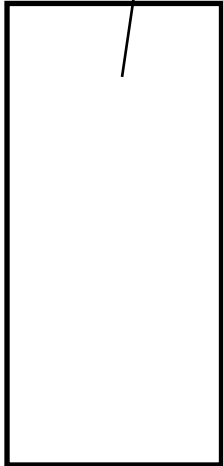

(b)(6), (b)(7)(A), (b)(7)(C), (b)(7)(D), (b)(7)(E), (b)(7)(F)

(b)(7)(A), (b)(7)(D), (b)(7)(E)

Understanding the Results Email



[Redacted]

7E-7

■ Scanned Copy of Original Request

- ("HH Task... .pdf") - A scanned copy of the packet that the Hemisphere [Redacted] receive

- The packet will contain additional documents (including our [Redacted] added by [Redacted] the Hemisphere Project

[Redacted]

7E-3

7E-7

7E-4

7E-4

**Scanned Copy of the
Original Request**

A scanned copy of the packet that
The Hemisphere [redacted] receive

(includes [redacted])

(b)(6), (b)(7)(A), (b)(7)(C), (b)(7)(D), (b)(7)(E), (b)(7)(F)

7E-7

7E-7

7E-3

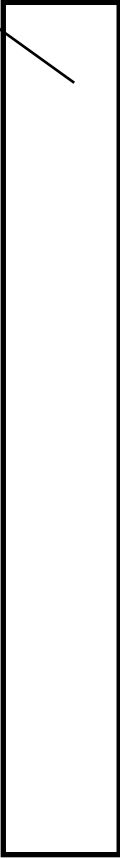
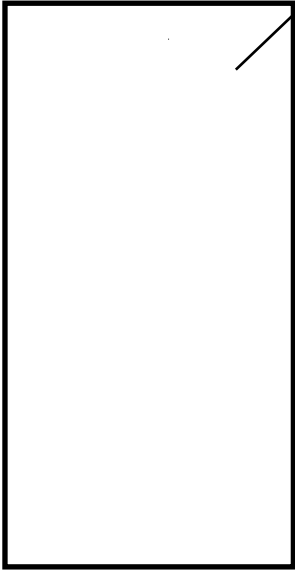

6-1, 7C-1, 7E-8, 7F-1

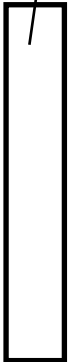

(b)(6), (b)(7)(A), (b)(7)(C), (b)(7)(D), (b)(7)(E), (b)(7)(F)

(b)(7)(A),(b)(7)(D),(b)(7)(E)

7E-11

7E-11

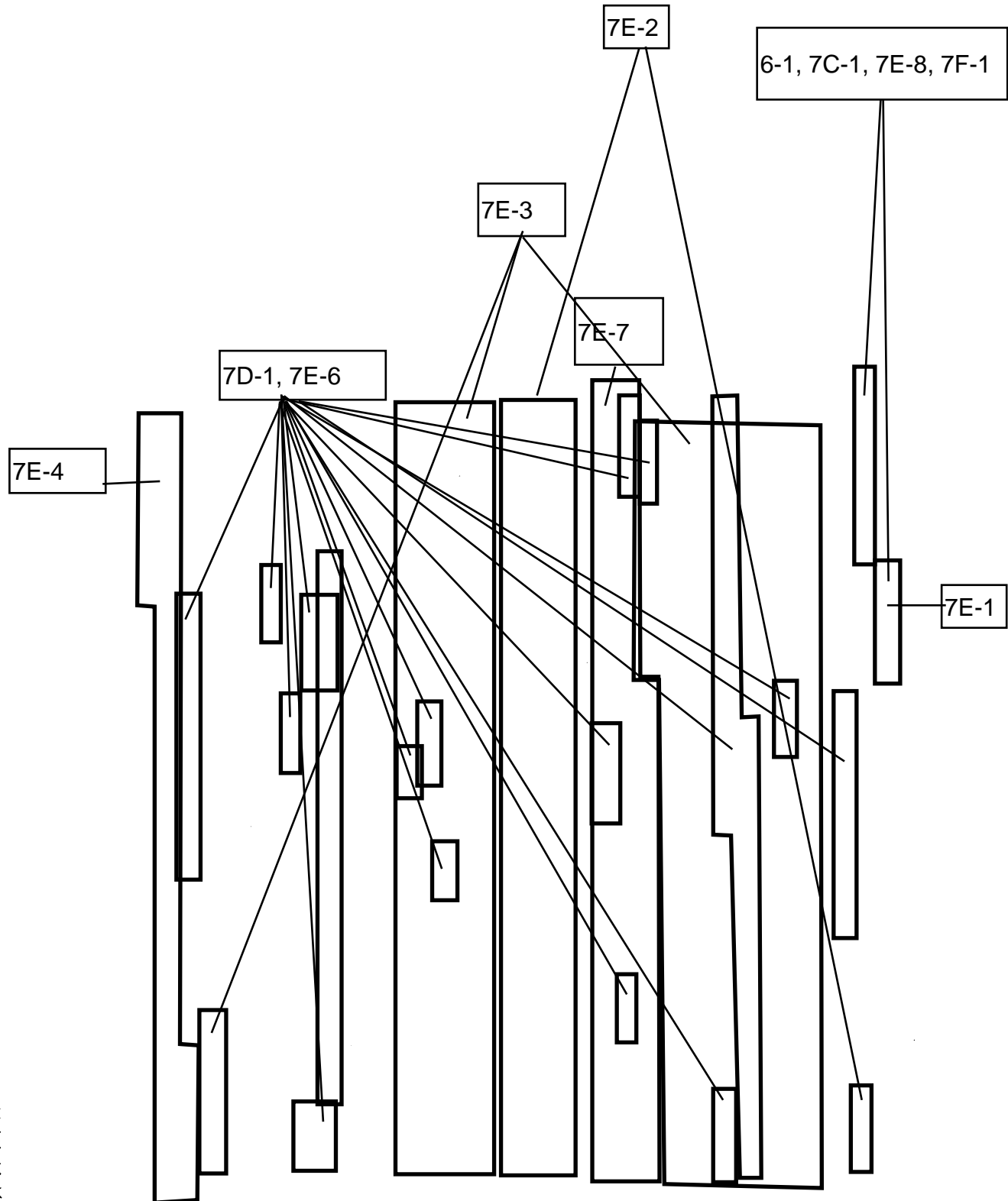

(b)(6), (b)(7)(A), (b)(7)(C), (b)(7)(D), (b)(7)(E), (b)(7)(F)



Summary Report

7E-7

(b)(7)(E)



Summary Report- Overview

7E-3

7E-7

7D-1, 7E-6

(b)(7)(A), (b)(7)(D), (b)(7)(E)

7E-7

(b)(7)(A), (b)(7)(C), (b)(7)(D), (b)(7)(E)



Report- Overview

7E-3

7E-7



(b)(7)(A), (b)(7)(D), (b)(7)(E)

7E-7

(b)(7)(A), (b)(7)(C), (b)(7)(D), (b)(7)(E)



Practical Exercises

[Redacted]
7E-7

(b)(7)(A), (b)(7)(D), (b)(7)(E) ■ § 6.0

REPORT

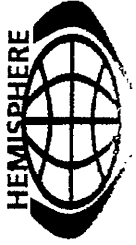

Overview

7E-3

7E-7

(b)(7)(A), (b)(7)(D), (b)(7)(E)

7E-7

7E-3

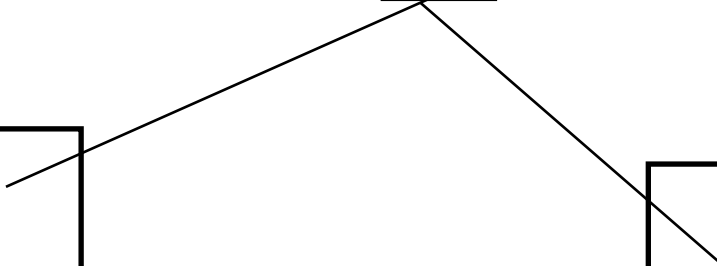
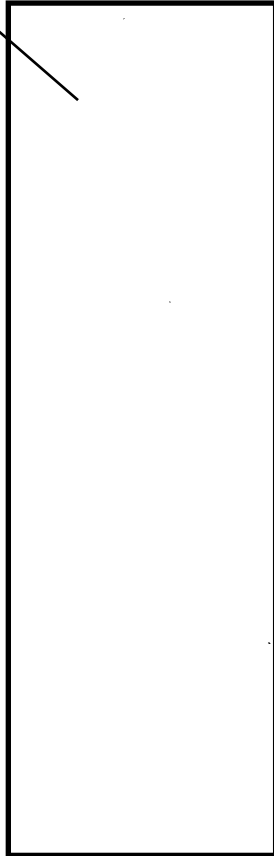

(7)(A), (b)(7)(C), (b)(7)(D), (b)(7)(E)

7E-7

7E-3

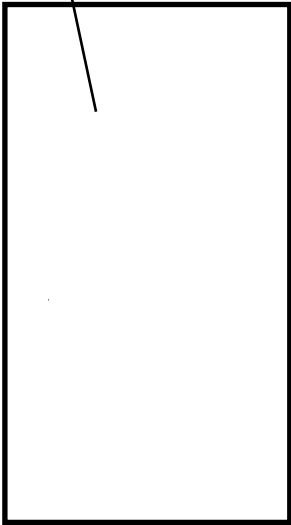

b)(7)(A), (b)(7)(C), (b)(7)(D), (b)(7)(E)



Practical Exercises

[Redacted]

7E-3

7E-7

[Redacted]

(b)(7)(A), (b)(7)(D), (b)(7)(E) ■ § 7.0



7E-7

(b)(7)(A)-(b)(7)(E)

(b)(6), (b)(7)(A), (b)(7)(C), (b)(7)(D), (b)(7)(E)

Importing Hemisphere Data



7E-7

(b)(7)(A),(b)(7)(E)

Importing Hemisphere Data



7E-7

(b)(6), (b)(7)(A), (b)(7)(C), (b)(7)(E), (b)(7)(F)

Importing Hemisphere Data



7E-7

(b)(7)(A), (b)(7)(E)

Importing Hemisphere Data



7E-7

(b)(7)(A), (b)(7)(E)

Importing Hemisphere Data



7E-7

(b)(6), (b)(7)(A), (b)(7)(C), (b)(7)(D), (b)(7)(E), (b)(7)(F)

Importing Hemisphere Data



7E-7

6-1, 7C-1, 7E-8, 7F-1

(b)(7)(A), (b)(7)(E)



Importing Hemisphere Data

7E-7

(b)(7)(A);(b)(7)(E)

Importing Hemisphere Data



7E-7

(b)(7)(A);(b)(7)(E)

Importing Hemisphere Data



7E-7

(b)(7)(A); (b)(7)(E)

Importing Hemisphere Data



7E-7

(b)(7)(A), (b)(7)(D), (b)(7)(E)



Review-Hemisphere Products:

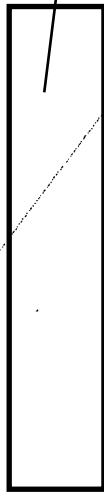

7E-3

7E-7

Practical Exercises



■ § 8.0 CUMULATIVE REVIEW

(b)(7)(A), (b)(7)(D), (b)(7)(E)

Hemisphere Products:

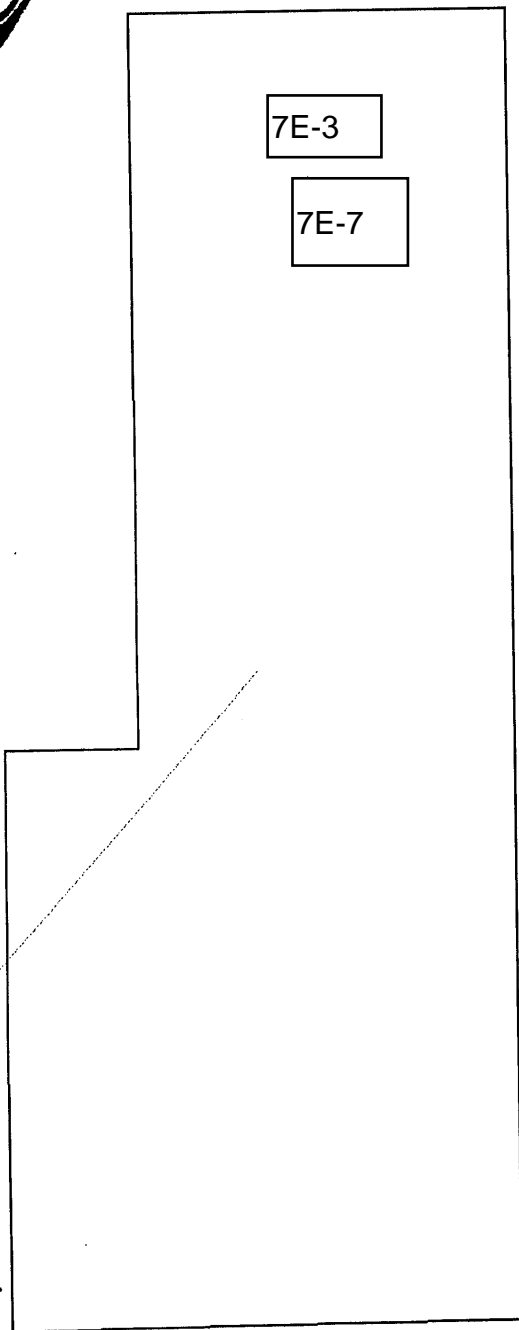

7E-3

7E-7



Searching For

7E-3

7E-7

(b)(7)(A), (b)(7)(D), (b)(7)(E)

7E-3

7E-7

(b)(7)(A), (b)(7)(C), (b)(7)(D), (b)(7)(E), (b)(7)(F)

7E-3

7E-7

b)(6), (b)(7)(A), (b)(7)(C), (b)(7)(D), (b)(7)(E), (b)(7)(F)



7E-3

7E-7

Hemisphere

(b)(7)(A), (b)(7)(D), (b)(7)(E)

Hemisphere

6-1, 7C-1, 7E-8, 7F-1



7E-3

7E-7

(b)(7)(A), (b)(7)(C), (b)(7)(D), (b)(7)(E), (b)(7)(F)

Questions?



Questions?
**Please contact your Hemisphere HIDTA
ISC P.O.C.**

Or, for assistance regarding:

- The identification of your appropriate P.O.C.*
- P.O.C. contact information*
- The arrangement of training sessions*
- General Hemisphere questions*

call the Houston Hemisphere Training Team at

[Redacted]

(b)(7)(C)

7E-1

(b)(5),(b)(6),(b)(7)(A),(b)(7)(C),(b)(7)(D),(b)(7)(E)

Non
Responsive

6-1, 7C-1, 7E-8, 7F-1

5-2

7E-3

7E-2

(b)(5),(b)(6),(b)(7)(A),(b)(7)(C),(b)(7)(D),(b)(7)(E)

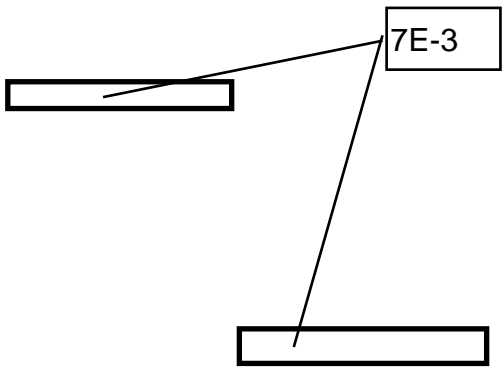

5-2



Hemisphere Project Request Form

7E-1

(b)(7)(C),(b)(7)(E)

LOS ANGELES HIDTA

Please Fax When Complete
LACLEAR Hemisphere Fax: []

Type of Request []

Master Case Number: [] Other Case Number: [] Date: []

Drug Type Associated with Investigation: [] Priority: []

HIDTA Point of Contact Name: [] **Email Results To:** []

POC Phone Number: [] **Email Notification Of Completion To:** []

Requestor Name: [] **Email Results To:** []

Requestor Phone Number: [] **Email Notification Of Completion To:** []

Drug Trafficking Organization/Name (if applicable) []

Case Name (if applicable): []

HIDTA Initiative? Yes No

HIDTA Initiative OR Law Enforcement Agency: []

(b)(7)(E)

Squad Name: []

Time Zone Results Requested in: []

7E-2

Page 2 HEMISPHERE REQUEST

Phone Number

Date Range Requested

		To	
		To	
		To	
		To	
		To	
		To	
		To	
		To	
		To	
		To	
		To	
		To	
		To	
		To	
		To	
		To	
		To	
		To	
		To	
		To	
		To	
		To	
		To	



Hemisphere Project Request Form

7E-1

7E-2

7E-9

Print Form

Please Fax When Complete

LACLEAR Hemisphere Fax: [Redacted]

(b)(7)(C),(b)(7)(E)

Questions? Phone: [Redacted]

(b)(7)(E)

Type of Request

Basic

Master Case Number: [Redacted]

Other Case Number: [Redacted]

Date: [Redacted]

Drug Type Associated with Investigation:

Narcotic Related

Priority: [Redacted]

Submitting Investigator/Analyst: [Redacted]

Secure Phone Number: [Redacted]

Lead Case Investigator if Different from Above: [Redacted]

Lead Case Investigator Phone Number: [Redacted]

E-mail Results To: [Redacted]

E-mail Notification of Completion To: [Redacted]

Drug Trafficking Organization/Name (if applicable): [Redacted]

Case Name (if applicable): [Redacted]

HIDTA Initiative?

Yes

No

HIDTA Initiative OR Law Enforcement Agency: [Redacted]

Squad Name: [Redacted]

(b)(7)(E)

Time Zone Results Requested in:

Pacific Standard Time (PST -8)

7E-2

